

# GUHRING

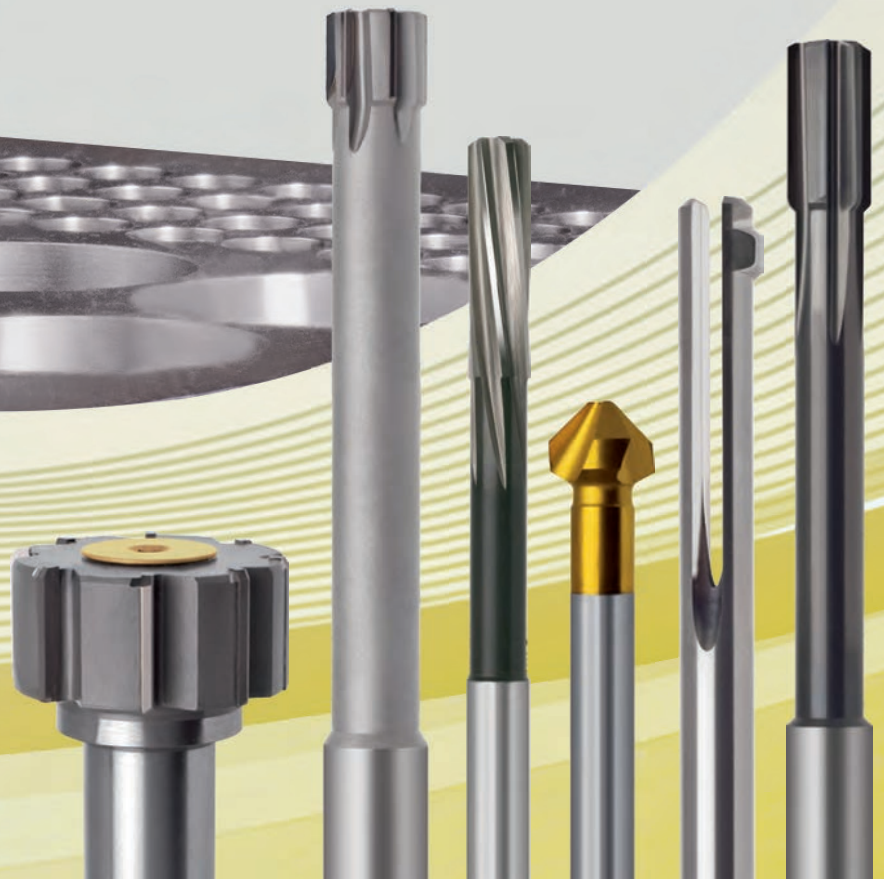

REAMERS, COUNTERSINKS  
DE-BURRING TOOLS  
COMPLETE RANGE 2014

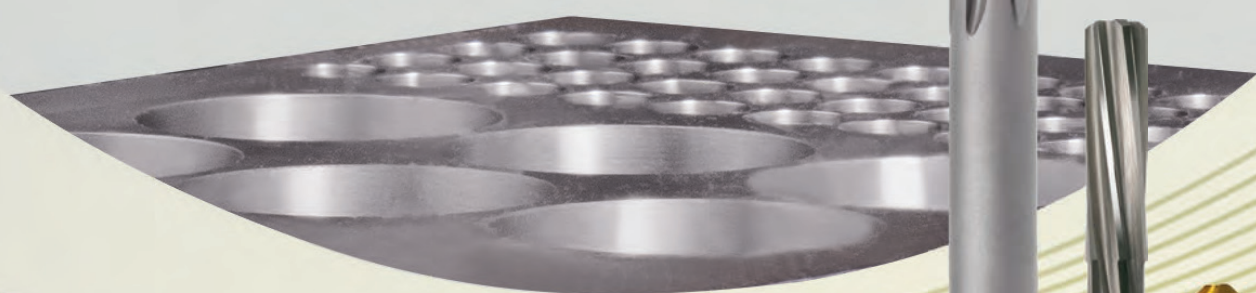

HR 500

# HIGH-PERFORMANCE REAMERS

## Perfect reaming in all diameters

HR 500 high-performance reamers are the optimal tooling solution for all diameters from 2.97 to 76.00 mm.

To apply the optimally designed HR 500 high-performance reamer a range of various HR 500 options is available.

- Solid carbide reamers up to diameter 20.00 mm
- Carbide and cermet-tipped reamers up to diameter 40.00 mm
- Carbide and cermet-tipped head reamers up to diameter 76.00 mm
- Solid carbide reamers for intermediate dimensions and stepped tools in HR 500 Active programme

## Maximum performance for all materials

Our comprehensive HR 500 range includes reamers for the machining of most materials. The perfect combination of special geometries, tool material and coatings provides optimal machining results for all reaming operations.





# DE-BURRING TOOLS

Hole entries and exits

- quick, clean and fully automated

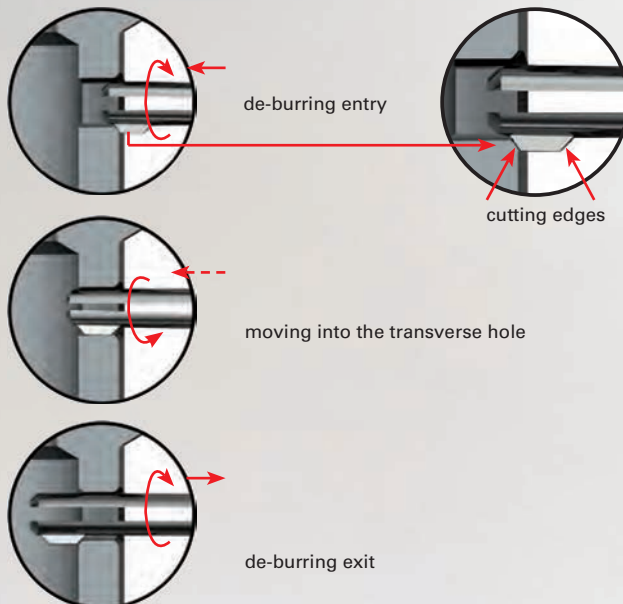

Guhring provides a comprehensive standard range of de-burring tools for the finish machining of hole entry, hole exit and transverse hole exit – including the world's first solid carbide tools for the machine de-burring of hole entry and exit.

Instead of a time and cost-intensive manual operation, de-burring in a fully automated operating process reduces the machining time.



# HOLDERS FOR FINISH MACHINING

Accuracy is a matter of setting

In order to achieve the best possible results with our precision reaming tools, they are clamped in Guhring holders for finish machining.

- Quick and simple adjustment
- Axial and radial  $\mu$ -accurate setting
- Compensates concentricity and alignment errors
- MQL capable



## Oberflächenqualität

### Umrechnungsverhältnisse nach DIN 47

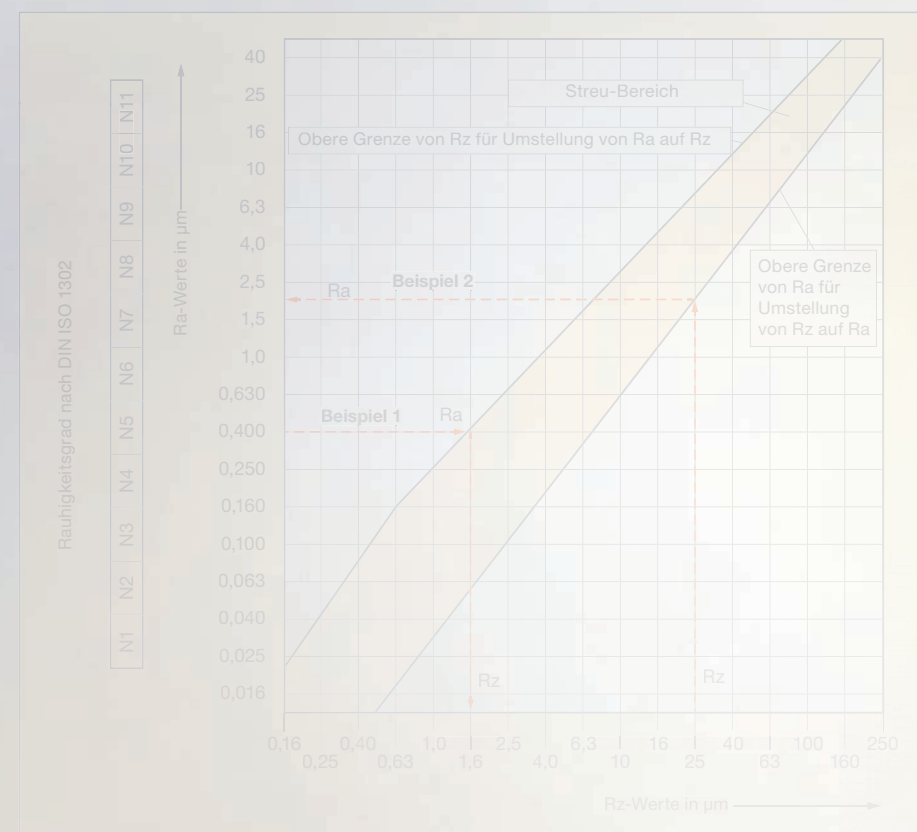

#### Beispiel 1 $R_a$ in $R_z$

Beim Vergleich des Mittenrauwertes  $R_a = 0,4 \mu\text{m}$  zur mittleren Rauhtiefe  $R_z$ , liegt diese bei  $R_z = 1,6$ .

#### Beispiel 2 $R_z$ in $R_a$

Beim Vergleich der gemittelten Rauhtiefe  $R_z = 25 \mu\text{m}$  zum Mittenrauwert  $R_a$ ,

liegt dies bei  $R_a = 2,5$ .

$R_z$ in $\mu\text{m}$	$R_a$ in $\mu\text{m}$
0,16	0,025
0,25	0,040
0,63	0,100
1,0	0,160
1,6	0,250
2,5	0,400
4,0	0,630
6,3	1,000
10	1,600
16	2,500
25	4,000
40	6,300
63	10,000
100	16,000
160	25,000
250	40,000

# INFO TABLES AT A GLANCE

## Surface Quality Conversion ratio to DIN 47

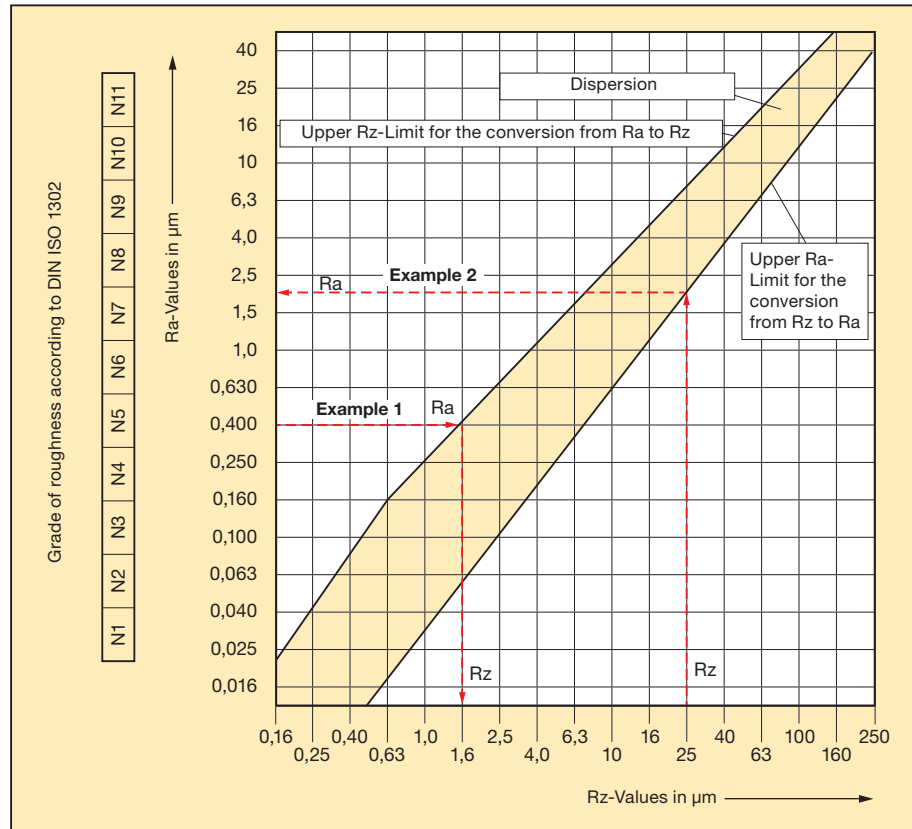

### Example 1: $R_a$ in $R_z$

When comparing the average roughness index  $R_a = 0.4 \mu\text{m}$  to the average roughness  $R_z$  we achieve a value of  $R_z = 1.6 \mu\text{m}$ .

### Example 2: $R_z$ in $R_a$

When comparing the average roughness  $R_z = 25 \mu\text{m}$  to the average roughness index  $R_a$  we achieve a value of  $R_a = 2 \mu\text{m}$ .

### Optimal diameters of pre-drilled holes

Recommended stock allowance, in mm		up to Ø6	up to Ø10	up to Ø16	up to Ø25	up to Ø40	above Ø40
all materials		Ø 0.1-0.2	Ø 0.2	Ø 0.2-0.3	Ø 0.3	Ø 0.3-0.4	Ø 0.4-0.5
hardened steel	H up to 48 HRC	Ø 0.1-0.2	Ø 0.2	Ø 0.2	Ø 0.2	Ø 0.3	Ø 0.3
	H up to 63 HRC	Ø 0.1	Ø 0.1	Ø 0.1-0.2	Ø 0.2	Ø 0.2	Ø 0.2

### Application recommendations for Guhring reaming, countersinking and de-burring tools

Application group	Material examples
<b>P</b>	Steel, high-alloyed steel
<b>M</b>	Stainless steel
<b>K</b>	Grey cast iron, spher. graphite iron/malleable cast iron
<b>N</b>	Aluminium and other non-ferrous metals
<b>S</b>	Special, super and titanium alloys
<b>H</b>	Hardened steel and chilled cast iron

## Pictograms

<b>Tool material</b>	VHM Solid carbide	HM Carbide-tipped	Cermet	HSS	HSS-E					
<b>Internal cooling</b>										
<b>Standard</b>	DIN 347	DIN 373	DIN 375	DIN 859	DIN 1862	DIN 1866	DIN 1868	DIN 2179	DIN 2180	
	DIN 6888	DIN 8054	DIN 8089	~DIN 8050	~DIN 8051	~DIN 8090	~DIN 8093	~DIN 8094	to Guhring standard	
	to DIN									
<b>Type</b>	HR 500 S	HR 500 Guss S	HR 500 Alu S	HR 500 G S	HR 500 GT S	HR 500 D	HR 500 Guss D	HR 500 Alu D	HR 500 G D	HR 500 GT D
	Blind hole (S)					Through hole (D)				
<b>Cutting direction</b>										
	r-h	l-h								
<b>Tolerance</b>	H7	+0,005	+0,004 +0,005							
<b>Hole type</b>										
	Through hole	Blind hole	Through and blind hole							
<b>No. of cutting edges</b>										
<b>Form</b>	A	B	C	D						
<b>Shank form</b>	HA	Cyl	MK							
<b>Helix angle</b>										
	straight-fluted	right-hand helix	left-hand helix							
<b>Spacing</b>										
	equal	unequal	extremely unequal							

Our price list no. 42 replaces all previous price lists. All prices in Euro plus surcharge and VAT. Re-production – even in part – is not permitted.

Possible misprints or any type of intermediate changes do not entitle to any claims. All DIN marked products can be supplied deviating from the catalogue dimensions as long as they correspond to the specified DIN standard.

Printed in Germany

Guhring KG  
P.O. Box 10 02 47 · D-72423 Albstadt  
Herderstrasse 50-54 · D-72458 Albstadt

Tel.: +49 74 31 17-0  
Fax: +49 74 31 17-21 279

Internet: [www.guehring.de](http://www.guehring.de)  
E-Mail: [info@guehring.de](mailto:info@guehring.de)

# ORDERING OPTIONS

When ordering please always state

**Guhring no. and Code no.**, i.e.:

“Carbide high-performance reamers,  
for nom.-Ø 2.97 mm” = **1675 2,970**

Guhring no.

### High-performance reamers

Solid carbide	
HR 500 S	HR 500 S
<b>Guhring no.</b>	<b>1685</b> <b>1675</b>
P (N/mm <sup>2</sup> )	●      ●
M	●      ●
K	●      ●
N	●      ●
S	●      ●
H (HRC)	63      63
Surface finish	a      a
Discount group	166      166

The solid carbide HPC reamer HR 500 S operates with highest cutting rates and produces extremely high-quality holes. Therefore, it often enables considerable savings in the process costs. In addition, it provides very high process reliability.

Code no.	d1	d2 h6	l1	l2	l4	
	mm	mm	mm	mm	mm	
2.970	2.970	4.000	68.00	40.00	12.00	4
2.980	2.980	4.000	68.00	40.00	12.00	4
2.990	2.990	4.000	68.00	40.00	12.00	4

Availability
●
●
●

Code no.

## Application recommendations for Guhring reaming, countersinking and de-burring tools

Application group	Material examples
P	Steel, high-alloyed steel
M	Stainless steel
K	Grey cast iron, spher. graphite iron/malleable cast iron
N	Aluminium and other non-ferrous metals
S	Special, super and titanium alloys
H	Hardened steel and chilled cast iron

On the following price and programme pages you will find for every tool recommendations regarding suitability for the application groups and details of max. tensile strength and hardness.

- optimal suitability
- limited suitability
- unsuitable

01



02

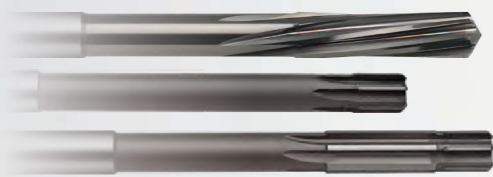

03



04



05



06

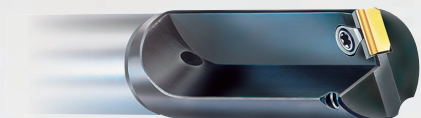

07

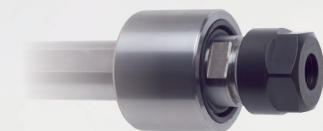

08



09



10



HR 500 HIGH-PERFORMANCE REAMERS

01

CARBIDE REAMERS

02

HIGH SPEED STEEL REAMERS

03

TAPER REAMERS

04

HIGH SPEED STEEL HAND REAMERS

05

PILOT TOOLS

06

CLAMPING DEVICES

07

COUNTERSINKING & DE-BURRING

08

NAVIGATOR / TECHNICAL SECTION

09

PRODUCT NO. INDEX

10



## Special solutions

High cutting speeds and feed rates, long tool life and tightest tolerances: Our cermet- and carbide-tipped special reamers promise optimal values combined with high process reliability and simple handling. Highest surface finish quality with HPC reaming operations with Guhring's special reamers!



# HR 500 HIGH-PERFORMANCE REAMERS

# High-performance reamers

Standard	Type	Tool illustration	Tool material	Surface finish	d1	Guhring no.	Discount group	Standard range page
----------	------	-------------------	---------------	----------------	----	-------------	----------------	---------------------

## High-performance reamers

	HR 500 S		Solid carbide		3.000 - 20.000	1685	166	14	
	HR 500 S		Solid carbide		2.970 - 12.030	1675	166	14	
	HR 500 D		Solid carbide		3.000 - 20.000	1686	166	17	
	HR 500 D		Solid carbide		2.970 - 12.030	1676	166	17	
	HR 500 Guss S		Solid carbide		3.000 - 20.000	1036	166	20	
	HR 500 Guss D		Solid carbide		3.000 - 20.000	1037	166	20	
	HR 500 Alu S		Solid carbide		4.000 - 20.000	1678	166	21	
	HR 500 Alu D		Solid carbide		4.000 - 20.000	1679	166	21	
	HR 500 G S		Carbide		22.000 - 40.000	1680	166	22	
	HR 500 G S		Cermet tipped		22.000 - 40.000	1682	166	22	
	HR 500 G D		Carbide		22.000 - 40.000	1681	166	23	
	HR 500 G D		Cermet tipped		22.000 - 40.000	1683	166	23	
	HR 500 GT S		Semi-standard	Carbide		41.000 - 76.000	1038	166	25
	HR 500 GT S		Semi-standard	Cermet tipped		41.000 - 76.000	1040	166	25
	HR 500 GT D		Semi-standard	Carbide		41.000 - 76.000	1039	166	26

bright   
 steam tempered   
 nitrided   
 TiAlN   
 TiAlN nanoA   
 Carbo   
 TiN   
 Signum

Standard	Type	Tool illustration	Tool material	Surface finish	d1	Guhring no.	Discount group	Standard range page
----------	------	-------------------	---------------	----------------	----	-------------	----------------	---------------------

## High-performance reamers

	HR 500 GT D		Semi-standard	Cermet tipped	○	41.000 - 76.000	<b>1041</b>	166	26
--	-------------	--	---------------	---------------	---	-----------------	-------------	-----	----

## HSK-A hydraulic chucks, extra length, for HR 500 GT

						HSK-A 63	<b>4290</b>	114	27
--	--	--	--	--	--	----------	-------------	-----	----

### Tool selection for optimal economy and quality

			Ø ≤ 20 mm			Ø > 20 mm		
			Solid carbide HR 500	Solid carbide HR500 Guss	Solid carbide HR500 Alu	Carbide tipped HR500	Cermet tipped HR500	
			<b>1675</b>	<b>1676</b>	<b>1036</b>	<b>1678</b>	<b>1680/1038</b>	<b>1682/1040</b>
			<b>1685</b>	<b>1686</b>	<b>1037</b>	<b>1679</b>	<b>1681/1039</b>	<b>1683/1041</b>
Steel	P	up to 1200 N/mm <sup>2</sup>	●	●			○	●
Stainless steel	M		●	●			●	
Cast iron	K	GG	○	○	●		●	
		GGG 40/50	○	○	●		○	●
		GGG 60/70	○	○	●		●	
Aluminium	N				●			
Ti-special alloys	S	Ti-Basis	●	●			●	
		Ni-Basis	●	●			●	
Hardened steel	H	up to 48 HRC	●	●			○	
		up to 63 HRC	●	●				

● optimal suitability

○ limited suitability

## Optimal diameters of pre-drilled holes

### Recommended stock allowance, in mm

			up to Ø6	up to Ø10	up to Ø16	up to Ø25	up to Ø40	above Ø40
all materials			Ø 0.1 - 0.2	Ø 0.2	Ø 0.2 - 0.3	Ø 0.3	Ø 0.3 - 0.4	Ø 0.4 - 0.5
Hardened steel	H	up to 48 HRC	Ø 0.1 - 0.2	Ø 0.2	Ø 0.2	Ø 0.2	Ø 0.3	Ø 0.3
		up to 63 HRC	Ø 0.1	Ø 0.1	Ø 0.1 - 0.2	Ø 0.2	Ø 0.2	Ø 0.2

○ bright

● steam tempered

● nitrided

**A** TiAN

**a** TiAN nanoA

**Cb** Carbo

**S** TiN













# High-performance reamers



## Solid carbide



Guhring no.	1686	1676
P (N/mm <sup>2</sup> )	●	●
M	●	●
K	○	○
N		
S	●	●
H (HRC)	63	63
Surface finish	ⓐ	ⓐ
Discount group	166	166
	H7	+0,005

The solid carbide HPC reamer HR 500 D operates with highest cutting rates (see Guhringguide) and produces extremely high-quality holes. Therefore, it often enables considerable savings in the process costs. In addition, it provides very high process reliability. The special coolant supply with flutes in the shank ensures optimal chip evacuation and reliable cooling.

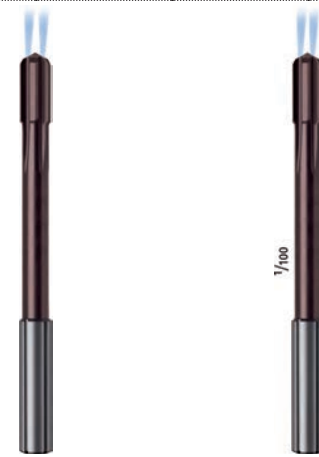
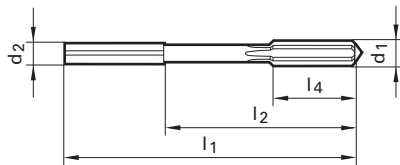

Code no.	d1	d2 h6	l1	l2	l4	
	mm	mm	mm	mm	mm	
12.030	12.030	12.000	130.00	85.00	19.00	6
13.000	13.000	14.000	130.00	85.00	22.00	6
14.000	14.000	14.000	130.00	85.00	22.00	6
15.000	15.000	16.000	150.00	102.00	22.00	6
16.000	16.000	16.000	150.00	102.00	22.00	6
17.000	17.000	18.000	150.00	102.00	25.00	6
18.000	18.000	18.000	150.00	102.00	25.00	6
19.000	19.000	20.000	150.00	100.00	25.00	6
20.000	20.000	20.000	150.00	100.00	25.00	6

Availability	
	●
●	
●	
●	
●	
●	
●	
●	
●	
●	

○ bright    ● steam tempered    ● nitrided    ● TiAlN    ● TiAlN nanoA    ● Carbo    ● TiN







# High-performance reamers



Carbide

Cermet tipped

HR 500  
G D



HR 500  
G D



Guhring no.

1681

1683

P (N/mm<sup>2</sup>)

○

1200

M

●

K

GG/GGG60

GGG40-50

N

S

H (HRC)

48

Surface finish

ⓐ

○

Discount group

166

166



H7



H7



The carbide- or cermet-tipped HR 500 G D produces first-class hole qualities with highest cutting rates. In addition, it provides a very high process reliability and considerably reduces process costs.

Further advantages:

- Intermediate dimensions from Ø 20.1 mm can be supplied at short notice
- Carbide-tipped tools with “Signum”-coating for GG machining meeting highest demands on surface quality of hole (cutting rates see Guhring no. 1036/1037)
- Carbide-tipped tools with “Carbo”-coating for the machining of aluminium (cutting rates see Guhring no. 1678/1679)

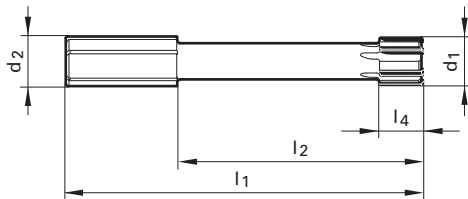

Code no.	d1	d2 h6	l1	l2	l4	
	mm	mm	mm	mm	mm	
22.000	22.000	20.000	160.00	110.00	22.00	6
24.000	24.000	25.000	180.00	124.00	22.00	6
25.000	25.000	25.000	180.00	124.00	22.00	6
26.000	26.000	25.000	180.00	124.00	22.00	6
28.000	28.000	25.000	180.00	124.00	25.00	6
30.000	30.000	25.000	180.00	124.00	25.00	6
32.000	32.000	32.000	200.00	140.00	25.00	6
34.000	34.000	32.000	200.00	140.00	25.00	6
36.000	36.000	32.000	200.00	140.00	25.00	8
38.000	38.000	32.000	200.00	140.00	25.00	8
40.000	40.000	32.000	200.00	140.00	25.00	8

Availability	
●	●
●	●
●	●
●	●
●	●
●	●
●	●
●	●
●	●
●	●

○ bright

● steam tempered

● nitrided

ⓐ TiAlN

ⓐ TiAlN nanoA

● Carbo

● TiN

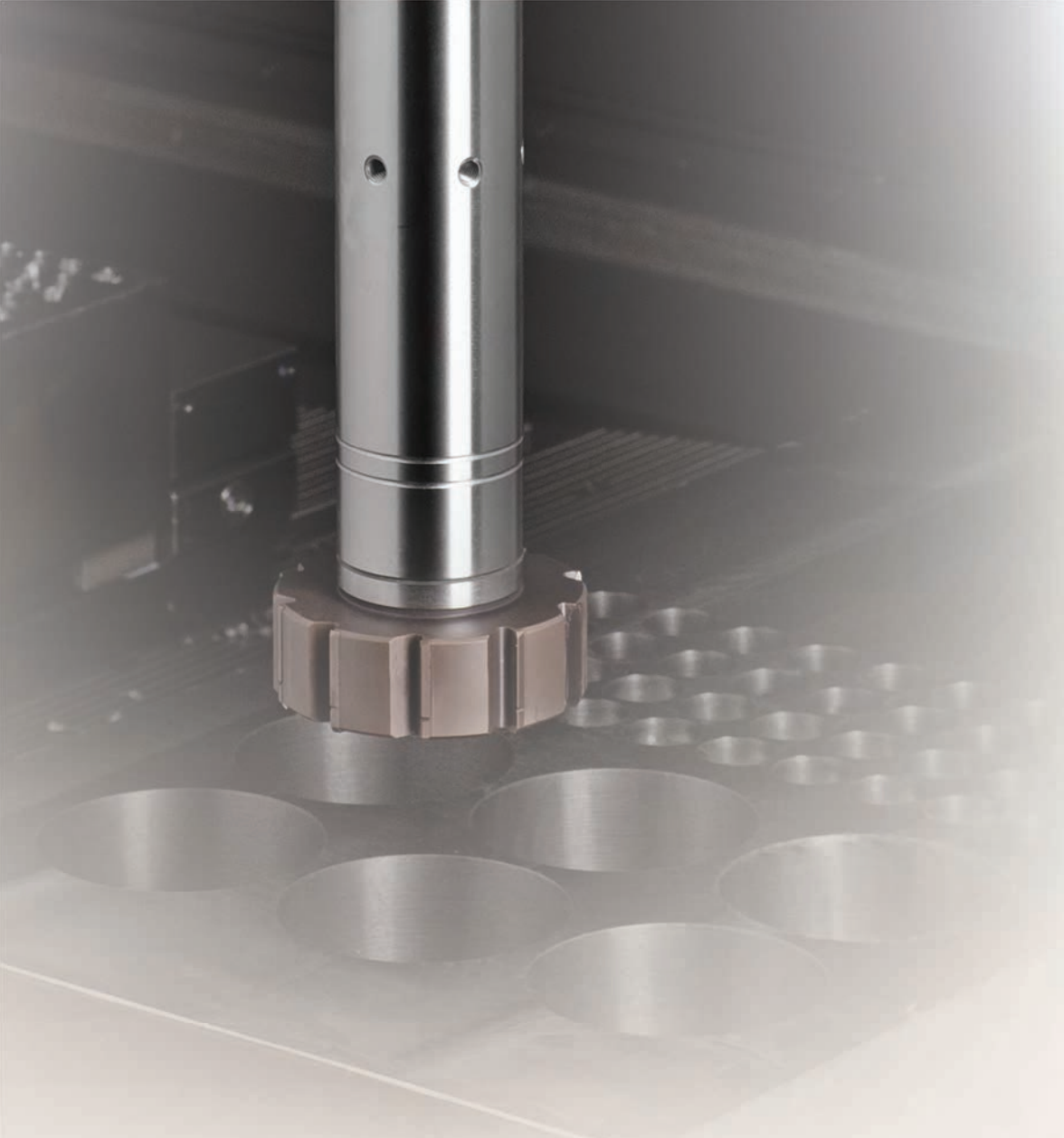

## HR 500 GT high-performance reamers top performance above $\varnothing$ 40.00 mm

Also for diameters above 40.00 mm Guhring's HR 500 technology is first choice for high-performance reaming. Numerous intelligent solutions ensure also with large diameters maximum cutting rates and optimal quality:

### Variety for perfect machining results

The HR 500 GT tool heads are available in the semi-standard range with short delivery times in the diameter range  $>$  40.00 to 76.00 mm for the following material specific ranges:

- Carbide-tipped with nanoA-coating for stainless steels, GGG 60, GG, special alloys and non-ferrous metals
- Carbide-tipped with Signum-coating for GG
- Carbide-tipped with Carbo-coating for Al machining
- Cermet-tipped for steels and GGG 40/50

In addition, we manufacture special tools to customer specific requirements on request.

### Optimal cooling lubrication

Thanks to the newly developed, patent applied for, re-direction screw at the face side of the HR 500 GT tool heads, the cooling lubricant process reliably reaches the cutting edges. It is impossible for chips to clog up the cooling lubricant exits. Thanks to the especially flat design of the re-direction screw the machining of blind holes is possible right up to the base of the hole.

If necessary, the re-direction screw can be removed for the machining of blind holes.











**EXCLUSIVE LINE®**  
**HR 500 ACTIVE**  
**Stufenreibahlen nach Maß**

**Bestellung**  **Anfrage**

Name/falls vorhanden Kunden-Nr.  Neukunde

Straße/Hausnummer

Telefon

Datum

Mindestbestellmenge 5 Stück.

Ansprechpartner für Rückfragen

Bestellnummer

PLZ/Ort

Telefax

Unterschrift

**Stückzahl**

**Bohrungs-Ø / Tol.**  **Stufen-Ø d<sub>2</sub> Tol. d<sub>2</sub>**  **Beispiele**  $\emptyset 12 \text{ F8}$   $\emptyset 10 \text{ H7}$  oder  $\emptyset 12 \text{ }^{+0,02}_{-0,004}$   $\emptyset 10 \text{ }^{\pm 0,02}$

oder **Reibahlenherstell-Ø / Tol.**  **ob.-/unt. Stufen-Ø d<sub>2</sub> ob.-/unt. Abmaß**  **Beispiel**  $\emptyset 12 \text{ }^{+0,01}_{+0,004}$   $\emptyset 10$

**zyl. Stufenlänge / Senkwinkel**  **Stufenlänge L<sub>3</sub> ±0,1**  **Senkwinkel W<sub>1</sub>**

**Bearbeitung**

mit Innenkühlung

ohne Innenkühlung

Stufenbohrung

Bohrer Senku

**Baumaße**

lange Ausführung

kurze Ausführung

Nenn-Ø d <sub>1</sub> Abmaß	Stufen-Ø d <sub>2</sub>	Ausraglänge		Anspr.
		L <sub>1</sub>	L <sub>2</sub>	
8, 101 - 8	d1 x 0,8	101	85	28
8, 101 - 10,1	d1 x 0,8	101	85	28
10, 101 - 10,1	d1 x 0,8	130	85	28
12, 101 - 12,1	d1 x 0,8	150	102	30
14, 101 - 14,1	d1 x 0,8	150	102	30
16, 101 - 16,1	d1 x 0,8	150	100	20
18, 101 - 18,1	d1 x 0,8	150	100	20

**Beschichtung**

TiAlN (optimal für Guss- und Stahlbearbeitung)

GG

blank (optimal für Al- und Titanbearbeitung)

AI

**Werkstoff**

Stahl/gehärtete Stähle/GGG/VA

Für Durchgangsbohrungen mit Längsnuten am Schaft (bei IK)

HR 500 ACTIVE **GUHRING** 4

## HR 500 ACTIVE

The special programme for solid carbide HR 500 high-performance reamers

Made-to-measure HR 500 special reamers with short delivery times and optimal price-performance ratio. Detailed information and enquiry forms can be found in the Technical Section.

# HR 500 ACTIVE

## Solid carbide reamers in special dimensions

[www.guehring.de](http://www.guehring.de)

**Order**       **Inquiry**

Name/customer no. if available       New customer

Street no.

Telephone

Date

Contact for questions

Order no.

Town/post code

Fax

Signature

**Quantity**  Minimum order quantity 5 tools

**Hole Ø / tol.**                  Example:  Ø 12 F8      Example:  Ø 12 +0,03 / +0,01

or

**Reamers manufact. Ø / tol.**            upper/lower limit      Example:  Ø 12 +0,008 / +0,002

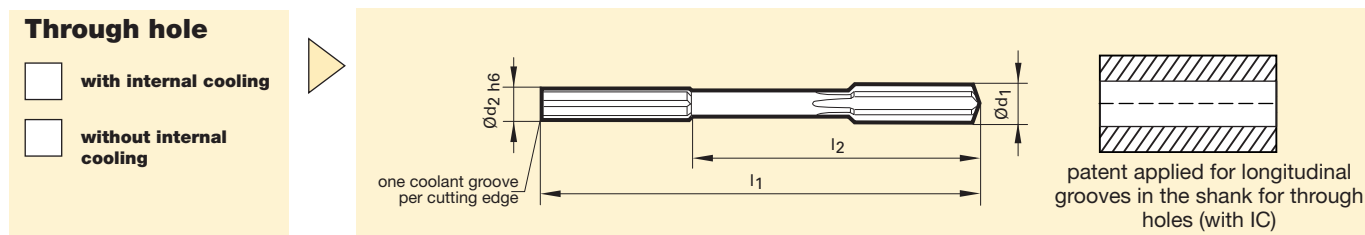
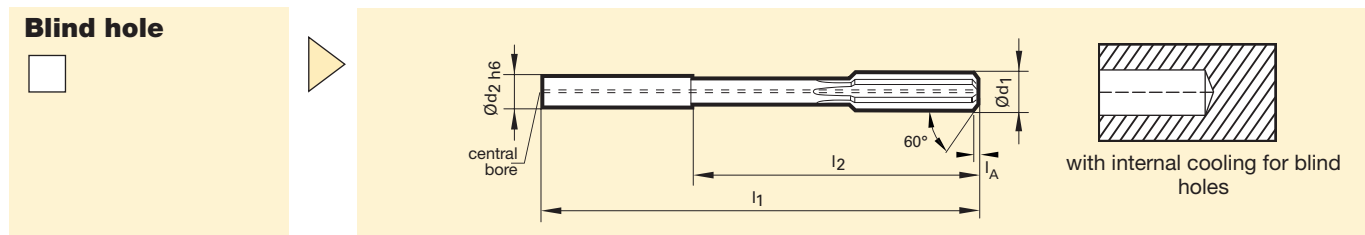

**Dimensions**

long version

short version

**Further dimensions on request**

Nom.-Ø [mm] from - to d <sub>1</sub>	long version		short version		Chamfer length l <sub>a</sub> (only blind holes)	Shank-Ø h6 DIN 6535 d <sub>2</sub>
	l <sub>1</sub>	Reach l <sub>2</sub>	l <sub>1</sub>	Reach l <sub>2</sub>		
2.950 - 4.1	68	40	-	-	0.4	4
4.101 - 6.1	76	40	-	-	0.4	6
6.101 - 8.1	101	65	76	40	0.4	8
8.101 - 10.1	101	61	76	36	0.4	10
10.101 - 12.1	130	85	80	35	0.5	12
12.101 - 14.1	130	85	90	45	0.5	14
14.101 - 16.1	150	102	90	42	0.5	16
16.101 - 18.1	150	102	100	52	0.5	18
18.101 - 20.1	150	100	100	50	0.5	20

**Coating**

TiAlN (optimal for the machining of steel and universal application)

Zenit (optimal for the machining of titanium)

Signum (optimal for the machining of GG/GGG)

Carbo (optimal for the machining of Al)

**Material**

steel/hardened steel/ special alloys/VA

GG/ GGG

HR 500 CAST: Delivery time appr. 4 weeks

Al-wrought-cast alloys

Delivery time appr. 5 weeks





# CARBIDE REAMERS









# Carbide reamers































Carbide reamers

Standard	Form	Tool illustration	Tool material	Surface finish	d1	Guhring no.	Discount group	Standard range page
----------	------	-------------------	---------------	----------------	----	-------------	----------------	---------------------

## NC machine reamers

	<b>B</b>		<b>Solid carbide</b>		0.980 - 12.050	<b>1427</b>	120	34
	<b>B</b>		<b>Solid carbide</b>		3.000 - 12.000	<b>1449</b>	120	34

## Machine reamers

	<b>A</b>		<b>Carbide</b>		5.000 - 20.000	<b>717</b>	120	39
	<b>B</b>		<b>Carbide</b>		5.000 - 20.000	<b>718</b>	120	39
	<b>A</b>		<b>Carbide</b>		1.000 - 20.000	<b>1408</b>	120	40
	<b>A</b>		<b>Carbide</b>		2.000 - 20.000	<b>1428</b>	120	40
	<b>B</b>		<b>Carbide</b>		1.000 - 20.000	<b>1409</b>	120	40
	<b>B</b>		<b>Carbide</b>		1.800 - 20.000	<b>1429</b>	120	40
	<b>A</b>		<b>Carbide</b>		5.000 - 40.000	<b>719</b>	120	42
	<b>B</b>		<b>Carbide</b>		6.000 - 32.000	<b>720</b>	120	42
	<b>A</b>		<b>Carbide</b>		6.000 - 28.000	<b>1410</b>	120	43
	<b>B</b>		<b>Carbide</b>		5.000 - 40.000	<b>1411</b>	120	43

## Machine reamers

	<b>A</b>		<b>Carbide</b>		4.000 - 15.000	<b>674</b>	120	44
---	----------	---	----------------	--	----------------	------------	-----	----

 bright  
  steam tempered  
  nitrided  
  TiAlN  
  TiAlN nanoA  
  Carbo  
  TiN



Standard	Form	Tool illustration	Tool material	Surface finish	d1	Guhring no.	Discount group	Standard range page
----------	------	-------------------	---------------	----------------	----	-------------	----------------	---------------------

## Machine reamers

~DIN 8090	A		Carbide		3.500 - 14.000	1430	120	44
~DIN 8090	B		Carbide		3.000 - 16.000	1407	120	44
~DIN 8090	C		Carbide		4.000 - 14.000	737	120	44

## Expanding machine reamers

	A		Carbide		8.000 - 18.000	749	120	45
	A		Carbide		8.000 - 30.000	740	120	46

## Stepped machine reamers

			Carbide		8.000 - 25.000	743	120	47
---	--	---	---------	--	----------------	-----	-----	----

## Shell reamers

DIN 8054			Carbide		25.000 - 55.000	727	120	48
----------	--	---	---------	--	-----------------	-----	-----	----

 bright

 steam tempered

 nitrided

 TiAlN

 TiAlN nanoA

 Carbo

 TiN

# NC machine reamers

Solid carbide



Ø > 3.75 mm with extremely unequal flute spacing  
Tolerance for Guhring no. 1427:  
≤ Ø 5.50 mm: 0.000/+0.004  
> Ø 5.50 mm: 0.000/+0.005

NC machine chucking reamers similar to DIN 8093 with straight shank (h6) for standardised tool clamping in hydraulic or shrink fit chucks offer highest concentricity and process reliability for the production of holes to required tolerances.



Guhring no.	1427	1449
P (N/mm <sup>2</sup> )	●	●
M	○	○
K	●	●
N	●	●
S	○	○
H (HRC)	52	52
Surface finish	○	○
Discount group	120	120
	+0,004 +0,005	H7

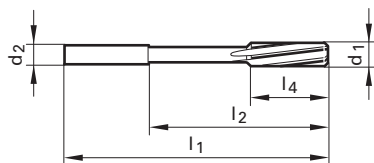

Code no.	d1	d2 h6	l1	l2	l4	
	mm	mm	mm	mm	mm	
0.980	0.980	4.000	50.00	22.00	6.00	3
0.990	0.990	4.000	50.00	22.00	6.00	3
1.000	1.000	4.000	50.00	22.00	6.00	3
1.010	1.010	4.000	50.00	22.00	6.00	3
1.020	1.020	4.000	50.00	22.00	6.00	3
1.030	1.030	4.000	50.00	22.00	9.00	3
1.480	1.480	4.000	50.00	22.00	9.00	3
1.490	1.490	4.000	50.00	22.00	9.00	3
1.500	1.500	4.000	50.00	22.00	9.00	3
1.510	1.510	4.000	50.00	22.00	9.00	3
1.520	1.520	4.000	50.00	22.00	9.00	3
1.530	1.530	4.000	50.00	22.00	9.00	3
1.980	1.980	4.000	50.00	22.00	12.00	4
1.990	1.990	4.000	50.00	22.00	12.00	4
2.000	2.000	4.000	50.00	22.00	12.00	4
2.010	2.010	4.000	50.00	22.00	12.00	4
2.020	2.020	4.000	50.00	22.00	12.00	4
2.030	2.030	4.000	50.00	22.00	12.00	4
2.480	2.480	4.000	60.00	32.00	16.00	4
2.490	2.490	4.000	60.00	32.00	16.00	4
2.500	2.500	4.000	60.00	32.00	16.00	4
2.510	2.510	4.000	60.00	32.00	16.00	4
2.520	2.520	4.000	60.00	32.00	16.00	4
2.530	2.530	4.000	60.00	32.00	16.00	4
2.970	2.970	4.000	64.00	36.00	17.00	6
2.980	2.980	4.000	64.00	36.00	17.00	6
2.990	2.990	4.000	64.00	36.00	17.00	6
3.000	3.000	4.000	64.00	36.00	17.00	6
3.010	3.010	4.000	64.00	36.00	17.00	6
3.020	3.020	4.000	64.00	36.00	17.00	6

Availability	
●	
●	
●	
●	
●	
●	
●	
●	
●	
●	
●	
●	
●	
●	
●	
●	
●	
●	
●	
●	
●	
●	●
●	
●	
●	

- bright
- steam tempered
- nitrided
- TiAlN
- TiAlN nanoA
- Carbo
- TiN

Carbide reamers





# NC machine reamers



$\varnothing > 3.75$  mm with extremely unequal flute spacing  
Tolerance for Guhring no. 1427:  
 $\leq \varnothing 5.50$  mm: 0.000/+0.004  
 $> \varnothing 5.50$  mm: 0.000/+0.005

NC machine chucking reamers similar to DIN 8093 with straight shank (h6) for standardised tool clamping in hydraulic or shrink fit chucks offer highest concentricity and process reliability for the production of holes to required tolerances.

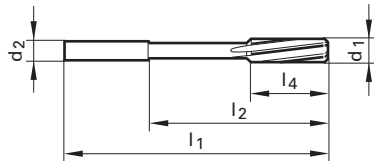

Code no.	d1	d2 h6	l1	l2	l4	
	mm	mm				
7.800	7.800	8.000	117.00	75.00	33.00	6
7.900	7.900	8.000	117.00	75.00	33.00	6
7.970	7.970	8.000	117.00	75.00	33.00	6
7.980	7.980	8.000	117.00	75.00	33.00	6
7.990	7.990	8.000	117.00	75.00	33.00	6
8.000	8.000	8.000	117.00	75.00	33.00	6
8.010	8.010	8.000	117.00	75.00	33.00	6
8.020	8.020	8.000	117.00	75.00	33.00	6
8.030	8.030	8.000	117.00	75.00	33.00	6
8.040	8.040	8.000	117.00	75.00	33.00	6
8.100	8.100	10.000	117.00	75.00	33.00	6
8.200	8.200	10.000	117.00	75.00	33.00	6
8.300	8.300	10.000	117.00	75.00	33.00	6
8.400	8.400	10.000	117.00	75.00	33.00	6
8.500	8.500	10.000	117.00	75.00	33.00	6
8.600	8.600	10.000	117.00	75.00	33.00	6
8.700	8.700	10.000	125.00	81.00	36.00	6
8.800	8.800	10.000	125.00	81.00	36.00	6
8.900	8.900	10.000	125.00	81.00	36.00	6
9.000	9.000	10.000	125.00	81.00	36.00	6
9.100	9.100	10.000	125.00	81.00	36.00	6
9.300	9.300	10.000	125.00	81.00	36.00	6
9.500	9.500	10.000	125.00	81.00	36.00	6
9.600	9.600	10.000	125.00	81.00	36.00	6
9.700	9.700	10.000	133.00	87.00	38.00	6
9.800	9.800	10.000	133.00	87.00	38.00	6
9.900	9.900	10.000	133.00	87.00	38.00	6
9.970	9.970	10.000	133.00	87.00	38.00	6
9.980	9.980	10.000	133.00	87.00	38.00	6
9.990	9.990	10.000	133.00	87.00	38.00	6

○ bright

● steam tempered

● nitrided

● TiAN

● TiAN nanoA

● Carbo

● TiN

## Solid carbide



Guhring no.	1427	1449
P (N/mm <sup>2</sup> )	●	●
M	○	○
K	●	●
N	●	●
S	○	○
H (HRC)	52	52
Surface finish	○	○
Discount group	120	120
	+0,004 +0,005	H7



Code no.	Availability
7.800	●
7.900	●
7.970	●
7.980	●
7.990	●
8.000	●
8.010	●
8.020	●
8.030	●
8.040	●
8.100	●
8.200	●
8.300	●
8.400	●
8.500	●
8.600	●
8.700	○
8.800	●
8.900	●
9.000	●
9.100	●
9.300	●
9.500	●
9.600	●
9.700	●
9.800	●
9.900	●
9.970	●
9.980	●
9.990	●



# Machine reamers

Carbide

~DIN  
8050

Cyl

≤ Ø 9,50 mm: solid carbide  
 > Ø 9.50 mm: carbide head  
 allocation to Guhring standard  
 ≤ Ø 9.50 mm with ext. centres on both ends  
 > Ø 9.50 mm with int. centres on both ends

<b>Guhring no.</b>	<b>717</b>	<b>718</b>
<b>P (N/mm²)</b>	<b>1400</b>	<b>1400</b>
<b>M</b>	○	○
<b>K</b>	●	●
<b>N</b>	●	●
<b>S</b>	○	○
<b>H (HRC)</b>	<b>48</b>	<b>48</b>
<b>Surface finish</b>	○	○
<b>Discount group</b>	<b>120</b>	<b>120</b>
	<b>H7</b>	<b>H7</b>

Carbide reamers

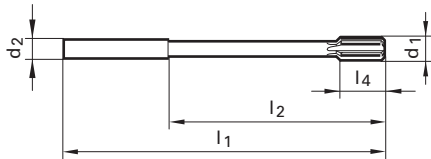

Code no.	d1	d2 h6	l1	l2	l4	
	mm	mm	mm	mm	mm	
5.000	5.000	5.000	86.00	52.00	12.00	6
6.000	6.000	5.600	93.00	57.00	12.00	6
7.000	7.000	7.100	109.00	69.00	16.00	6
8.000	8.000	8.000	117.00	75.00	16.00	6
9.000	9.000	9.000	125.00	81.00	19.00	6
10.000	10.000	10.000	133.00	87.00	12.00	6
11.000	11.000	10.000	142.00	96.00	12.00	6
12.000	12.000	10.000	151.00	105.00	12.00	6
13.000	13.000	10.000	151.00	105.00	12.00	6
14.000	14.000	12.000	160.00	110.00	16.00	6
15.000	15.000	12.000	162.00	112.00	16.00	6
16.000	16.000	12.000	170.00	120.00	19.00	6
18.000	18.000	14.000	182.00	130.00	19.00	6
20.000	20.000	16.000	195.00	137.00	19.00	6

Availability	
●	●
●	●
●	●
●	●
●	●
●	●
●	●
●	●
●	●
●	●
●	●
●	●
●	●
●	●
●	●
●	●
●	●
●	●
●	●
●	●
●	●
●	●

○ bright    ● steam tempered    ● nitrided    ● A TiAlN    ● a TiAlN nanoA    ● Cb Carbo    ● S TiN





# Machine reamers

~DIN 8093

Cyl

≥ Ø 3.0 mm with extreme unequal flute spacing  
 ≤ Ø 9,50 mm: solid carbide  
 > Ø 9.50 mm: carbide head  
 ≤ Ø 9.50 mm with ext. centres on both ends  
 > Ø 9.50 mm with int. centres on both ends  
 shank Ø < 10.0 mm tolerance h9,  
 shank Ø ≥ 10.0 mm tolerance h6

Carbide

	A	A	B	B
	EU	EU	EU	EU
<b>Guhring no.</b>	<b>1408</b>	<b>1428</b>	<b>1409</b>	<b>1429</b>
<b>P (N/mm<sup>2</sup>)</b>	<b>1400</b>	<b>1400</b>	<b>1400</b>	<b>1400</b>
<b>M</b>	○	○	○	○
<b>K</b>	●	●	●	●
<b>N</b>	●	●	●	●
<b>S</b>	○	○	○	○
<b>H (HRC)</b>	<b>48</b>	<b>48</b>	<b>48</b>	<b>48</b>
<b>Surface finish</b>	○	<b>a</b>	○	<b>a</b>
<b>Discount group</b>	<b>120</b>	<b>120</b>	<b>120</b>	<b>120</b>

Carbide reamers

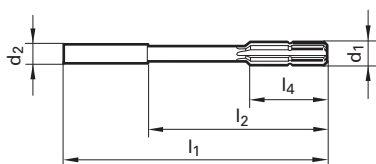

Code no.	d1	d2 h6/h9	l1	l2	l4	
	mm	mm	mm	mm	mm	
14.000	14.000	12.000	160.00	110.00	47.00	6
15.000	15.000	12.000	162.00	112.00	50.00	6
16.000	16.000	12.000	170.00	120.00	52.00	6
17.000	17.000	14.000	175.00	123.00	54.00	6
18.000	18.000	14.000	182.00	130.00	56.00	6
19.000	19.000	16.000	189.00	131.00	58.00	6
20.000	20.000	16.000	195.00	137.00	60.00	6

Availability			
●	●	●	●
●	●	●	●
●	●	●	○
●	●	●	○
●	●	●	●

○ bright    ● steam tempered    ● nitrided    ● TiAlN    ● TiAlN nanoA    ● Carbo    ● TiN

# Machine reamers

Carbide

~DIN 8051

MK

≤ Ø 9,50 mm: solid carbide  
 > Ø 9.50 mm: carbide head  
 allocation to Guhring standard  
 ≤ Ø 9.50 mm with ext. centre on cutting end  
 int. centre on shank end  
 > Ø 9.50 mm with int. centres on both ends



A



B



Guhring no.	719	720
P (N/mm <sup>2</sup> )	1400	1400
M	○	○
K	●	●
N	●	●
S	○	○
H (HRC)	48	48
Surface finish	○	○
Discount group	120	120
	H7	H7

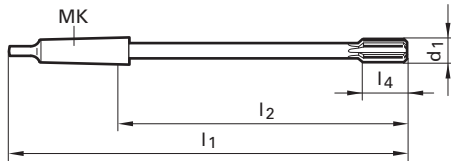

Code no.	d1	MK	l1	l2	l4	
	mm					
5.000	5.000	1	133.00	71.00	12.00	6
6.000	6.000	1	138.00	76.00	12.00	6
7.000	7.000	1	150.00	88.00	16.00	6
8.000	8.000	1	156.00	94.00	16.00	6
10.000	10.000	1	168.00	106.00	12.00	6
11.000	11.000	1	175.00	113.00	12.00	6
12.000	12.000	1	182.00	120.00	12.00	6
13.000	13.000	1	182.00	120.00	12.00	6
14.000	14.000	1	189.00	127.00	16.00	6
15.000	15.000	2	204.00	129.00	16.00	6
16.000	16.000	2	210.00	135.00	19.00	6
17.000	17.000	2	214.00	139.00	19.00	6
18.000	18.000	2	219.00	144.00	19.00	6
20.000	20.000	2	228.00	153.00	19.00	6
21.000	21.000	2	232.00	157.00	22.00	6
22.000	22.000	2	237.00	162.00	22.00	6
23.000	23.000	2	241.00	166.00	22.00	6
24.000	24.000	3	268.00	174.00	22.00	8
25.000	25.000	3	268.00	174.00	22.00	8
26.000	26.000	3	273.00	179.00	22.00	8
28.000	28.000	3	277.00	183.00	25.00	8
30.000	30.000	3	281.00	187.00	25.00	8
32.000	32.000	4	317.00	199.50	25.00	8
40.000	40.000	4	329.00	211.50	25.00	8

Availability	
●	
●	●
●	
●	●
●	○
●	●
●	○
●	●
●	●
●	●
●	●
●	●
●	●
●	●
●	●
●	●
●	●
●	●
●	●
●	●
●	●
○	●
○	●

○ bright    ● steam tempered    ● nitrided    ● TiAN    ● TiAN nanoA    ● Carbo    ● TiN











# Shell reamers

Carbide

DIN 8054



with carbide inserts

The shell reamers have a taper bore with a taper 1 : 30 and a driving slot to DIN 138. Holder Guhring no. 1438.

<b>Guhring no.</b>	<b>727</b>
<b>P (N/mm<sup>2</sup>)</b>	<b>1400</b>
<b>M</b>	○
<b>K</b>	●
<b>N</b>	●
<b>S</b>	○
<b>H (HRC)</b>	<b>48</b>
<b>Surface finish</b>	○
<b>Discount group</b>	<b>120</b>

R

H7

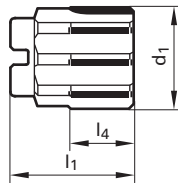

Code no.	d1	int. Ø	l1	l4	
	mm	mm	mm	mm	
25.000	25.000	13.000	45.00	30.00	6
35.000	35.000	13.000	45.00	30.00	8
36.000	36.000	16.000	50.00	30.00	8
38.000	38.000	16.000	50.00	30.00	8
40.000	40.000	16.000	50.00	30.00	8
50.000	50.000	19.000	56.00	30.00	10
55.000	55.000	22.000	63.00	30.00	10

Availability
○
○
○
○
○
○
○

○ bright    ● steam tempered    ● nitrided    ● TiAlN    ● TiAlN nanoA    ● Carbo    ● TiN

Carbide reamers







# HIGH SPEED STEEL REAMERS











# High speed steel reamers

Standard	Form	Tool illustration	Tool material	Surface finish	d1	Guhring no.	Discount group	Standard range page
----------	------	-------------------	---------------	----------------	----	-------------	----------------	---------------------

## NC machine reamers

DIN 212-3	B		HSS-E	○	1.000 - 12.020	455	105	54
DIN 212-3	B		HSS-E	○	1.500 - 20.000	490	105	54

## Machine reamers

DIN 212	A		HSS-E	○	1.000 - 5.500	401	105	59
DIN 212	B		HSS-E	○	1.000 - 3.700	402	105	59
DIN 212	A		HSS-E	○	1.000 - 6.000	457	105	59
DIN 212-2	A		HSS-E	○	4.000 - 20.000	440	105	60
DIN 212-2	B		HSS-E	○	3.800 - 20.000	468	105	60
DIN 212-2	B		HSS-E	Ⓢ	4.000 - 20.000	641	105	60
DIN 212-2	A		HSS-E	○	4.500 - 10.000	467	105	60
DIN 212	B		HSS-E	○	0.950 - 12.050	496	105	62
DIN 208	A		HSS-E	○	3.000 - 40.000	404	105	64
DIN 208	B		HSS-E	○	3.000 - 50.000	405	105	64
DIN 208	B		HSS-E	Ⓢ	8.000 - 20.000	642	105	64

○ bright

● steam tempered

● nitrided

Ⓐ TiAIN

ⓐ TiAIN nanoA

Ⓒb Carbo

Ⓢ TiN

Standard	Form	Tool illustration	Tool material	Surface finish	d1	Guhring no.	Discount group	Standard range page
----------	------	-------------------	---------------	----------------	----	-------------	----------------	---------------------

## Machine reamers with coolant duct

DIN 212-2	A		HSS-E	○	5.000 - 20.000	1431	105	66
-----------	---	---	-------	---	----------------	------	-----	----

## Machine reamers with coolant duct

DIN 8089	A		HSS-E	○	5.000 - 18.000	1432	105	67
----------	---	---	-------	---	----------------	------	-----	----

## Machine reamers

DIN 8089	A		HSS-E	○	4.000 - 20.000	488	105	68
----------	---	---	-------	---	----------------	-----	-----	----

DIN 8089	B		HSS-E	○	4.000 - 20.000	489	105	68
----------	---	--	-------	---	----------------	-----	-----	----

DIN 8089	B		HSS-E	○	3.760 - 12.040	497	105	69
----------	---	---	-------	---	----------------	-----	-----	----

## Machine reamer sets

DIN 8089	B		HSS-E	○	-	458	105	70
----------	---	--	-------	---	---	-----	-----	----

## Quick spiral reamers

DIN 212-1	C		HSS-E	○	1.000 - 5.500	403	105	71
-----------	---	---	-------	---	---------------	-----	-----	----

DIN 212-2	C		HSS-E	○	4.000 - 20.000	469	105	71
-----------	---	---	-------	---	----------------	-----	-----	----

DIN 208	C		HSS-E	○	3.000 - 30.000	406	105	73
---------	---	---	-------	---	----------------	-----	-----	----

## Machine bridge reamers







DIN 311			HSS	●	6.400 - 40.000	414	105	74
---------	--	---	-----	---	----------------	-----	-----	----

○ bright    ● steam tempered    ● nitrided    ● TiAlN    ● TiAlN nanoA    ● Carbo    ● TiN

# High speed steel reamers

Standard	Form	Tool illustration	Tool material	Surface finish	d1	Guhring no.	Discount group	Standard range page
----------	------	-------------------	---------------	----------------	----	-------------	----------------	---------------------









## Machine bottoming reamers

	<b>A</b>		HSS-E		3.000 - 12.000	<b>419</b>	105	75
	<b>A</b>		HSS-E		3.000 - 25.000	<b>420</b>	105	76

## Stepped machine reamers

			HSS-E		5.000 - 38.000	<b>431</b>	105	77
---	--	---	-------	--	----------------	------------	-----	----

## Shell reamers

	<b>A</b>		HSS-E		29.000 - 98.000	<b>407</b>	105	78
	<b>B</b>		HSS-E		25.000 - 75.000	<b>408</b>	105	78
	<b>C</b>		HSS-E		29.000 - 98.000	<b>409</b>	105	79

 bright

 steam tempered

 nitrided

 TiAlN

 TiAlN nanoA

 Carbo

 TiN

Standard	Type	Tool illustration	Tool material	Surface finish	d1	Guhring no.	Discount group	Standard range page
<b>Arbors, complete</b>								
DIN 217					-	1438	105	80
<b>Arbors without accessories</b>								
G					-	1434	105	81
<b>Woodruff keys</b>								
DIN 6888					-	1437	105	82
<b>Draw-off nuts</b>								
G					-	1435	105	83
<b>Driving collars</b>								
G					-	1436	105	84

High speed steel reamers





# NC machine reamers

DIN 212-3



HSS-E



Guhring no.	455	490
P (N/mm <sup>2</sup> )	1000	1000
M	○	○
K	●	●
N	●	●
S	○	○
H (HRC)		
Surface finish	○	○
Discount group	105	105
	+0,004 +0,005	H7

≤ Ø 3.75 mm with external centres on both ends  
 > Ø 3.75 mm with internal centres on both ends  
 Tolerance for Guhring no. 455:  
 ≤ Ø 5.50 mm: 0.000/+0.004  
 > Ø 5.50 mm: 0.000/+0.005

The combination of NC machine chucking reamer and hydraulic, high precision clamping or shrink fit chuck respectively offers highest concentricity and process reliability for the production of holes to required tolerances. NC machine chucking reamers are similar to DIN 212 with straight shank (h6) for standardised tool clamping in hydraulic or shrink fit chucks. Short delivery for intermediate sizes.

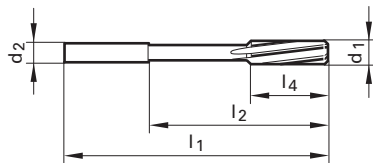

Code no.	d1	d2 h6	l1	l2	l4	
	mm	mm	mm	mm	mm	
5.010	5.010	5.000	86.00	58.00	23.00	6
5.020	5.020	5.000	86.00	58.00	23.00	6
5.030	5.030	5.000	86.00	58.00	23.00	6
5.100	5.100	5.000	86.00	58.00	23.00	6
5.200	5.200	5.000	86.00	58.00	23.00	6
5.300	5.300	5.000	86.00	58.00	23.00	6
5.400	5.400	6.000	93.00	57.00	26.00	6
5.500	5.500	6.000	93.00	57.00	26.00	6
5.600	5.600	6.000	93.00	57.00	26.00	6
5.700	5.700	6.000	93.00	57.00	26.00	6
5.800	5.800	6.000	93.00	57.00	26.00	6
5.900	5.900	6.000	93.00	57.00	26.00	6
5.980	5.980	6.000	93.00	57.00	26.00	6
5.990	5.990	6.000	93.00	57.00	26.00	6
6.000	6.000	6.000	93.00	57.00	26.00	6
6.010	6.010	6.000	101.00	65.00	28.00	6
6.020	6.020	6.000	101.00	65.00	28.00	6
6.030	6.030	6.000	101.00	65.00	28.00	6
6.100	6.100	6.000	101.00	65.00	28.00	6
6.200	6.200	6.000	101.00	65.00	28.00	6
6.300	6.300	6.000	101.00	65.00	28.00	6
6.400	6.400	6.000	101.00	65.00	28.00	6
6.500	6.500	6.000	101.00	65.00	28.00	6
6.600	6.600	6.000	101.00	65.00	28.00	6
6.800	6.800	8.000	109.00	73.00	31.00	6
6.900	6.900	8.000	109.00	73.00	31.00	6
7.000	7.000	8.000	109.00	73.00	31.00	6
7.100	7.100	8.000	109.00	73.00	31.00	6
7.300	7.300	8.000	109.00	73.00	31.00	6
7.400	7.400	8.000	109.00	73.00	31.00	6

Availability	
●	
●	
●	
	●
	●
	●
	●
	●
	●
	●
	●
	●
	●
	●
	●
	●
	●
	●
	●
	●
	●
	●
	●
	●
	○

○ bright    ● steam tempered    ● nitrided    ● TiAlN    ● TiAlN nanoA    ● Carbo    ● TiN

High speed steel reamers

















# Machine reamers

DIN 208



HSS-E

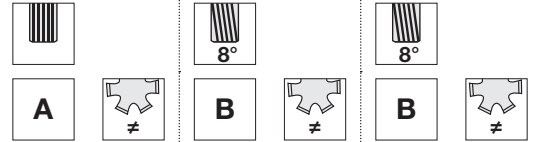

Ø 3.00 mm with external centre on cutting end, with internal centre on shank end  
 > Ø 3.00 mm with internal centres on both ends  
 ≤ Ø 4.00 mm to Guhring Standard

Guhring no.	404	405	642
P (N/mm <sup>2</sup> )	1000	1000	1000
M	○	○	○
K	●	●	●
N	●	●	○
S	○	○	○
H (HRC)			
Surface finish	○	○	Ⓢ
Discount group	105	105	105

High speed steel reamers

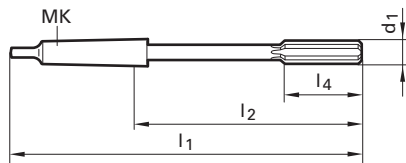

Code no.	d1	MK	l1	l2	l4	
	mm					
3.000	3.000	1	115.00	53.00	15.00	6
4.000	4.000	1	125.00	63.00	19.00	6
5.000	5.000	1	133.00	71.00	23.00	6
5.100	5.100	1	133.00	71.00	23.00	6
5.500	5.500	1	138.00	76.00	26.00	6
6.000	6.000	1	138.00	76.00	26.00	6
6.100	6.100	1	144.00	82.00	28.00	6
6.200	6.200	1	144.00	82.00	28.00	6
6.500	6.500	1	144.00	82.00	28.00	6
7.000	7.000	1	150.00	88.00	31.00	6
7.500	7.500	1	150.00	88.00	31.00	6
8.000	8.000	1	156.00	94.00	33.00	6
8.500	8.500	1	156.00	94.00	33.00	6
9.000	9.000	1	162.00	100.00	36.00	6
9.500	9.500	1	162.00	100.00	36.00	6
9.800	9.800	1	168.00	106.00	38.00	6
10.000	10.000	1	168.00	106.00	38.00	6
10.100	10.100	1	168.00	106.00	38.00	6
11.000	11.000	1	175.00	113.00	41.00	6
12.000	12.000	1	182.00	120.00	44.00	6
13.000	13.000	1	182.00	120.00	44.00	6
14.000	14.000	1	189.00	127.00	47.00	8
15.000	15.000	2	204.00	129.00	50.00	8
15.700	15.700	2	210.00	135.00	52.00	8
16.000	16.000	2	210.00	135.00	52.00	8
17.000	17.000	2	214.00	139.00	54.00	8
18.000	18.000	2	219.00	144.00	56.00	8
19.000	19.000	2	223.00	148.00	58.00	8
19.500	19.500	2	228.00	153.00	60.00	8
20.000	20.000	2	228.00	153.00	60.00	8

Availability		
●	●	
●	●	
●	●	
○		
○		
●	●	
●		
●	●	
●		
○	●	○
○		
●	●	
○		●
○		
●	●	●
●	●	●
●	●	●
●	●	●
●	●	●
●	●	○
○	●	○
●	●	●

○ bright    ● steam tempered    ● nitrided    ● TiAlN    ● TiAlN nanoA    ● Carbo    ● TiN





# Machine reamers with coolant duct

HSS-E

DIN 212-2

Cyl



A



Guhring no.

1431

P (N/mm<sup>2</sup>)

1000

M



K



N



S



H (HRC)

Surface finish



Discount group

105



H7



≤ Ø 3.75 mm with external centres on both ends  
 > Ø 3.75 mm with internal centres on both ends  
 with axial coolant duct for the machining of blind holes

High speed steel reamers

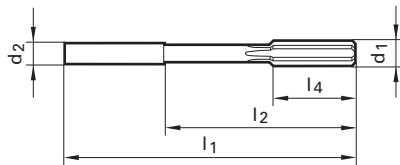

Code no.	d1	d2 h9	l1	l2	l4	
	mm	mm	mm	mm	mm	
5.000	5.000	5.000	86.00	58.00	23.00	6
5.500	5.500	5.600	93.00	57.00	26.00	6
6.000	6.000	5.600	93.00	57.00	26.00	6
6.500	6.500	6.300	101.00	65.00	28.00	6
8.000	8.000	8.000	117.00	81.00	33.00	6
9.500	9.500	9.000	125.00	85.00	36.00	6
10.000	10.000	10.000	133.00	93.00	38.00	6
11.500	11.500	10.000	142.00	102.00	41.00	6
12.000	12.000	10.000	151.00	111.00	44.00	6
14.000	14.000	12.500	160.00	115.00	47.00	8
16.000	16.000	12.500	170.00	125.00	52.00	8
17.000	17.000	14.000	175.00	130.00	54.00	8
19.000	19.000	16.000	189.00	141.00	58.00	8
20.000	20.000	16.000	195.00	147.00	60.00	8

Availability
●
●
○
●
○
●
○
●

○ bright    ● steam tempered    ● nitrided    ● TiAN    ● TiAN nanoA    ● Carbo    ● TiN



# Machine reamers

HSS-E

DIN 8089

Cyl

≤ Ø 3.75 mm with external centres on both ends  
 > Ø 3.75 mm with internal centres on both ends

High speed steel reamers

Guhring no.	488	489
P (N/mm <sup>2</sup> )	1000	1000
M	○	○
K	●	●
N	●	●
S	○	○
H (HRC)		
Surface finish	○	○
Discount group	105	105
	H7	H7

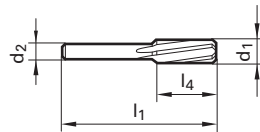

Code no.	d1	d2 h8	l1	l4	
	mm	mm	mm	mm	
4.000	4.000	3.550	56.00	20.00	6
4.500	4.500	4.000	63.00	22.00	6
5.000	5.000	4.000	63.00	22.00	6
6.000	6.000	5.000	63.00	22.00	6
6.500	6.500	5.000	63.00	22.00	6
7.000	7.000	6.300	71.00	25.00	6
7.500	7.500	6.300	71.00	25.00	6
8.000	8.000	6.300	71.00	25.00	6
8.500	8.500	6.300	71.00	25.00	6
9.000	9.000	8.000	71.00	25.00	6
10.000	10.000	8.000	71.00	25.00	6
10.500	10.500	8.000	71.00	25.00	6
11.000	11.000	10.000	80.00	28.00	6
11.500	11.500	10.000	80.00	28.00	6
12.000	12.000	10.000	80.00	28.00	6
13.000	13.000	10.000	80.00	28.00	6
14.000	14.000	12.500	90.00	32.00	8
15.000	15.000	12.500	90.00	32.00	8
16.000	16.000	12.500	90.00	32.00	8
17.000	17.000	12.500	90.00	32.00	8
18.000	18.000	16.000	100.00	36.00	8
19.000	19.000	16.000	100.00	36.00	8
20.000	20.000	16.000	100.00	36.00	8

Availability	
●	●
○	●
●	●
●	●
○	●
●	●
●	●
●	●
○	○
●	●
●	●
○	●
●	●
●	○
○	●
●	●

○ bright    ● steam tempered    ● nitrided    ● TiAN    ● TiAN nanoA    ● Carbo    ● TiN

# Machine reamers

HSS-E

DIN 8089

Cyl



B



Guhring no.

497

P (N/mm<sup>2</sup>)

1000

M



K



N



S



H (HRC)

Surface



Discount group

105



+0,004  
+0,005



Ø in increments of 0.01 mm  
 ≤ Ø 3.75 mm with ext. centres on both ends  
 > Ø 3.75 mm with int. centres on both ends  
 Tolerance:  
 ≤ Ø 5.50 mm: 0.000/+0.004  
 > Ø 5.50 mm: 0.000/+0.005

High speed steel reamers

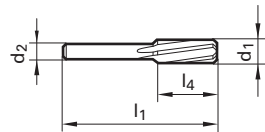

Code no.	from d1	to d1	d2 h8	l1	l4	
	mm	mm	mm	mm	mm	
	3.760	3.810	3.550	56.000	20.000	6
	3.830	4.200	3.550	56.000	20.000	6
	4.210	4.250	3.550	56.000	20.000	6
	4.260	5.300	4.000	63.000	22.000	6
	4.760	5.200	4.000	63.000	22.000	6
	5.310	6.110	5.000	63.000	22.000	6
	6.120	6.700	5.000	63.000	22.000	6
	6.710	8.200	6.300	71.000	25.000	6
	8.210	8.500	6.300	71.000	25.000	6
	9.990	10.000	8.000	71.000	25.000	6
	10.210	10.600	8.000	71.000	25.000	6
	10.610	11.200	10.000	80.000	28.000	6
	11.210	12.040	10.000	80.000	28.000	6

Availability
●
●
●
●
○
●
●
○
●
●
○
○

- bright
- steam tempered
- nitrided
- TiAlN
- TiAlN nanoA
- Carbo
- TiN

# Machine reamer sets

HSS-E

DIN 8089

Cyl



8°

B



Set consists of Guhring no. 497.

Guhring no.

458

P (N/mm<sup>2</sup>)

1000

M

○

K

●

N

●

S

○

H (HRC)

Surface finish

○

Discount group

105



+0,004  
+0,005



High speed steel reamers



Code no.	from d1	to d1	Pieces per set	Availability
	mm	mm		
9.400	8.810	9.400	60.00	○
10.500	10.010	10.500	50.00	○
11.000	10.510	11.000	50.00	○
12.000	11.510	12.000	50.00	○

○ bright    ● steam tempered    ● nitrided    ● TiAlN    ● TiAlN nanoA    ● Carbo    ● TiN









DIN 311



with internal centres on both ends  
1:10 on taper lead length  
Manufacturing tolerance k11

Guhring no. 414

P (N/mm<sup>2</sup>) 1000

M

K

N

S

H (HRC)

Surface finish

Discount group

105



High speed steel reamers

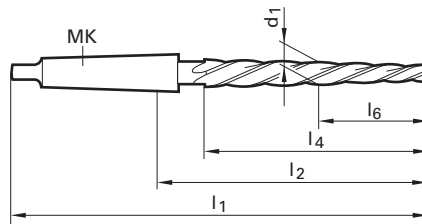

Code no.	d1	MK	l1	l2	l4	l6	
	mm						
6.400	6.400	1	151.00	89.00	75.00	19.00	4
8.400	8.400	1	161.00	99.00	85.00	25.00	4
9.500	9.500	1	166.00	104.00	90.00	27.00	4
10.000	10.000	1	171.00	109.00	95.00	30.00	4
11.000	11.000	1	176.00	114.00	100.00	33.00	4
12.000	12.000	2	199.00	124.00	105.00	39.00	4
13.000	13.000	2	199.00	124.00	105.00	39.00	4
14.000	14.000	2	209.00	134.00	115.00	42.00	5
15.000	15.000	2	219.00	144.00	125.00	45.00	5
16.000	16.000	2	229.00	154.00	135.00	48.00	5
17.000	17.000	3	251.00	157.00	135.00	51.00	5
18.000	18.000	3	261.00	167.00	145.00	58.00	5
19.000	19.000	3	261.00	167.00	145.00	58.00	5
20.000	20.000	3	271.00	177.00	155.00	62.00	5
21.000	21.000	3	271.00	177.00	155.00	62.00	5
22.000	22.000	3	281.00	187.00	165.00	66.00	5
23.000	23.000	3	281.00	187.00	165.00	66.00	5
24.000	24.000	3	296.00	202.00	180.00	72.00	5
25.000	25.000	3	296.00	202.00	180.00	72.00	5
26.000	26.000	3	296.00	202.00	180.00	72.00	5
27.000	27.000	3	311.00	217.00	195.00	78.00	5
28.000	28.000	3	311.00	217.00	195.00	78.00	5
30.000	30.000	3	311.00	217.00	195.00	78.00	5
31.000	31.000	3	326.00	232.00	210.00	84.00	5
32.000	32.000	4	354.00	236.50	210.00	84.00	5
37.000	37.000	4	364.00	246.50	220.00	88.00	5
40.000	40.000	4	374.00	256.50	230.00	92.00	5

Availability
○
○
●
●
●
●
●
●
●
●
●
●
●
●
●
●
●
●
●
○
○

○ bright    ● steam tempered    ● nitrided    ● TiAlN    ● TiAlN nanoA    ● Carbo    ● TiN

# Machine bottoming reamers

HSS-E



**Guhring no.** 419

**P (N/mm<sup>2</sup>)** 1000

**M**

**K**

**N**

**S**

**H (HRC)**

**Surface finish**

**Discount group**

105



Stable reamer to correct positional errors when pre-machining or to produce accurate location bores.

High speed steel reamers

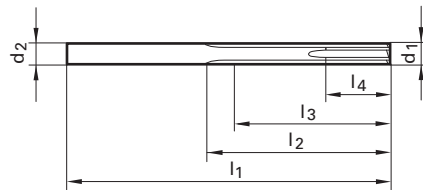

Code no.	d1	d2	int. Ø	l1	l2	l3	l4		Availability
	mm	mm	mm	mm	mm	mm	mm		
3.000	3.000	3.000	1.500	61.00	37.00	33.00	12.00	6	●
4.000	4.000	4.000	1.700	75.00	48.00	44.00	16.00	6	●
4.500	4.500	4.500	1.700	80.00	52.00	48.00	16.00	6	○
5.000	5.000	5.000	1.700	86.00	59.00	53.00	20.00	6	●
6.000	6.000	6.000	2.000	93.00	65.00	59.00	20.00	6	●
7.000	7.000	7.000	2.500	109.00	75.00	69.00	22.00	6	●
8.000	8.000	8.000	3.000	117.00	81.00	71.00	24.00	6	●
10.000	10.000	10.000	4.500	133.00	94.00	84.00	26.00	6	●
12.000	12.000	12.000	4.500	151.00	106.00	96.00	26.00	6	○

○ bright    ● steam tempered    ● nitrided    ● TiAlN    ● TiAlN nanoA    ● Carbo    ● TiN

# Machine bottoming reamers

HSS-E



Guhring no. 420

P (N/mm<sup>2</sup>) 1000

M

K

N

S

H (HRC)

Surface finish

Discount group

105



Stable reamer to correct positional errors when pre-machining or to produce accurate location bores.

High speed steel reamers

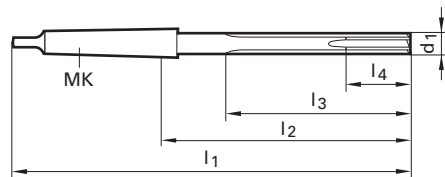

Code no.	d1	MK	int. Ø	l1	l2	l3	l4		Availability
	mm		mm						
3.000	3.000	1	1.500	114.00	52.00	37.00	12.00	6	<input type="radio"/>
3.500	3.500	1	1.500	120.00	58.00	44.00	12.00	6	<input type="radio"/>
7.000	7.000	1	2.500	150.00	88.00	75.00	22.00	6	<input type="radio"/>
10.000	10.000	1	4.500	168.00	106.00	94.00	26.00	6	<input type="radio"/>
12.000	12.000	1	4.500	182.00	120.00	106.00	26.00	6	<input checked="" type="radio"/>
16.000	16.000	2	6.000	210.00	135.00	123.00	30.00	8	<input type="radio"/>
18.000	18.000	2	6.000	219.00	144.00	132.00	30.00	8	<input type="radio"/>
20.000	20.000	2	8.000	228.00	153.00	139.00	32.00	8	<input checked="" type="radio"/>
25.000	25.000	3	12.000	268.00	174.00	159.00	36.00	8	<input type="radio"/>

- bright
- steam tempered
- nitrided
- TiAlN
- TiAlN nanoA
- Carbo
- TiN

# Stepped machine reamers

HSS-E



with internal centres on both ends

Thanks to the large guide length, these reamers offer high quality and alignment accuracy for pre-machining and finishing operations.

<b>Guhring no.</b>	<b>431</b>
<b>P (N/mm<sup>2</sup>)</b>	<b>1000</b>
<b>M</b>	
<b>K</b>	●
<b>N</b>	●
<b>S</b>	
<b>H (HRC)</b>	
<b>Surface finish</b>	○
<b>Discount group</b>	<b>105</b>

High speed steel reamers

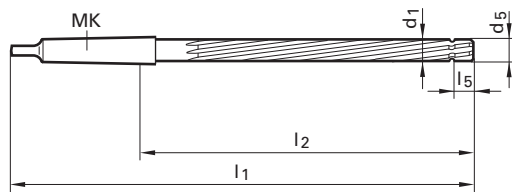

Code no.	d1	MK	d5	l1	l2	l5	
	mm		mm				
5.000	5.000	1	4.920	165.00	103.00	10.00	6
6.000	6.000	1	5.920	165.00	103.00	10.00	6
8.000	8.000	1	7.920	205.00	143.00	10.00	6
10.000	10.000	1	9.900	230.00	168.00	12.00	6
12.000	12.000	1	11.900	230.00	168.00	12.00	6
14.000	14.000	1	13.900	230.00	168.00	12.00	8
16.000	16.000	2	15.900	250.00	175.00	12.00	8
20.000	20.000	2	19.900	260.00	185.00	15.00	8
25.000	25.000	3	24.850	285.00	191.00	15.00	8
32.000	32.000	4	31.850	330.00	212.50	15.00	10
38.000	38.000	4	37.850	345.00	227.50	15.00	10

Availability	
●	
●	
●	
●	
●	
●	
●	
○	
○	
○	

- bright
- steam tempered
- nitrided
- TiAlN
- TiAlN nanoA
- Carbo
- TiN

# Shell reamers

HSS-E

DIN 219

High speed steel reamers

The shell reamers have a taper bore with a taper 1 : 30 and a driving slot to DIN 138.

	<b>A</b>	<b>B</b>
<b>Guhring no.</b>	<b>407</b>	<b>408</b>
<b>P (N/mm²)</b>	<b>1000</b>	<b>1000</b>
<b>M</b>	○	○
<b>K</b>	●	●
<b>N</b>	●	●
<b>S</b>	○	○
<b>H (HRC)</b>		
<b>Surface finish</b>	●	●
<b>Discount group</b>	<b>105</b>	<b>105</b>
	<b>H7</b>	<b>H7</b>

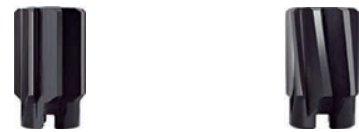
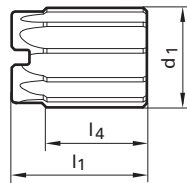

Code no.	d1	int. Ø	l1	l4	
	mm	mm	mm	mm	
25.000	25.000	13.000	45.00	32.00	8
29.000	29.000	13.000	45.00	32.00	8
30.000	30.000	13.000	45.00	32.00	8
32.000	32.000	16.000	50.00	36.00	10
33.000	33.000	16.000	50.00	36.00	10
34.000	34.000	16.000	50.00	36.00	10
35.000	35.000	16.000	50.00	36.00	10
36.000	36.000	19.000	56.00	40.00	10
38.000	38.000	19.000	56.00	40.00	10
40.000	40.000	19.000	56.00	40.00	10
42.000	42.000	19.000	56.00	40.00	10
44.000	44.000	22.000	63.00	45.00	12
45.000	45.000	22.000	63.00	45.00	12
46.000	46.000	22.000	63.00	45.00	12
50.000	50.000	22.000	63.00	45.00	12
52.000	52.000	27.000	71.00	50.00	12
55.000	55.000	27.000	71.00	50.00	12
58.000	58.000	27.000	71.00	50.00	12
60.000	60.000	27.000	71.00	50.00	12
62.000	62.000	32.000	80.00	56.00	14
65.000	65.000	32.000	80.00	56.00	14
70.000	70.000	32.000	80.00	56.00	14
75.000	75.000	40.000	90.00	63.00	14
90.000	90.000	50.000	100.00	71.00	16
98.000	98.000	50.000	100.00	71.00	16

Availability	
○	●
●	●
	●
	●
●	●
○	●
●	●
	●
●	●
	●
	●
	●
	●
	●
	●
	●
	●
●	●
○	●

○ bright    ● steam tempered    ● nitrided    ● TiAN    ● TiAN nanoA    ● Carbo    ● TiN

# Shell reamers

HSS-E

DIN 219



<b>Guhring no.</b>	<b>409</b>
<b>P (N/mm<sup>2</sup>)</b>	<b>1000</b>
<b>M</b>	
<b>K</b>	
<b>N</b>	●
<b>S</b>	
<b>H (HRC)</b>	
<b>Surface finish</b>	●
<b>Discount group</b>	<b>105</b>

The shell reamers have a taper bore with a taper 1 : 30 and a driving slot to DIN 138.

High speed steel reamers

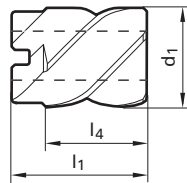

Code no.	d1	int. Ø	l1	l4	
	mm	mm	mm	mm	
29.000	29.000	13.000	45.00	32.00	3
30.000	30.000	13.000	45.00	32.00	3
34.000	34.000	16.000	50.00	36.00	3
35.000	35.000	16.000	50.00	36.00	3
40.000	40.000	19.000	56.00	40.00	5
42.000	42.000	19.000	56.00	40.00	5
50.000	50.000	22.000	63.00	45.00	5
60.000	60.000	27.000	71.00	50.00	5
88.000	88.000	50.000	100.00	71.00	7
92.000	92.000	50.000	100.00	71.00	7
95.000	95.000	50.000	100.00	71.00	7
98.000	98.000	50.000	100.00	71.00	7

Availability
○
●
○
●
○
○
●
●
○
○
○
○
○
○
○
○
○
○
○
○

- bright
- steam tempered
- nitrided
- TiAlN
- TiAlN nanoA
- Carbo
- TiN

# Arbors, complete

DIN  
217



High speed steel reamers

**Guhring no.** 1438

**P (N/mm<sup>2</sup>)**

**M**

**K**

**N**

**S**

**H (HRC)**

**Surface finish**

**Discount group**

105

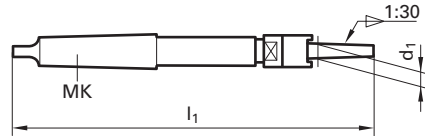

Code no.	d1	MK	l1
	mm		
13.000	13.000	3	250.00
16.000	16.000	3	261.00
19.000	19.000	4	298.00
22.000	22.000	4	312.00
27.000	27.000	5	359.00
32.000	32.000	5	376.00
40.000	40.000	5	396.00
50.000	50.000	5	416.00

Availability
●
●
●
●
●
●
●
○

- bright
- steam tempered
- nitrided
- A TiAlN
- a TiAlN nanoA
- Cb Carbo
- S TiN



# Arbors without accessories



**Guhring no.** 1434

**P (N/mm²)**

**M**

**K**

**N**

**S**

**H (HRC)**

**Surface finish**

**Discount group**

105

High speed steel reamers

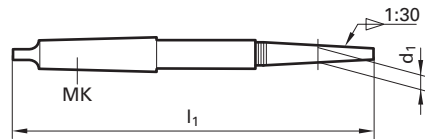

Code no.	d1	MK	l1
	mm		
13.000	13.000	3	250.00
16.000	16.000	3	261.00
19.000	19.000	4	298.00
22.000	22.000	4	312.00
27.000	27.000	5	359.00
32.000	32.000	5	376.00
40.000	40.000	5	396.00

Availability
<input type="radio"/>
<input type="radio"/>
<input type="radio"/>
<input type="radio"/>
<input type="radio"/>
<input type="radio"/>
<input type="radio"/>
<input type="radio"/>
<input type="radio"/>
<input type="radio"/>
<input type="radio"/>
<input type="radio"/>
<input type="radio"/>
<input type="radio"/>
<input type="radio"/>
<input type="radio"/>
<input type="radio"/>
<input type="radio"/>
<input type="radio"/>
<input type="radio"/>
<input type="radio"/>
<input type="radio"/>

- bright
- steam tempered
- nitrided
- TiAlN
- TiAlN nanoA
- Carbo
- TiN

# Woodruff keys

DIN  
6888

High speed steel reamers

<b>Guhring no.</b>	<b>1437</b>
<b>P (N/mm<sup>2</sup>)</b>	
<b>M</b>	
<b>K</b>	
<b>N</b>	
<b>S</b>	
<b>H (HRC)</b>	
<b>Surface finish</b>	
<b>Discount group</b>	<b>105</b>

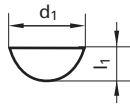

Code no.	d1	l1	Holder	Thickness	Availability
	mm	mm	mm		
13.000	13.000	3.70	13	3.000	<input type="radio"/>
16.000	16.000	5.00	16	4.000	<input type="radio"/>
22.000	22.000	6.50	19/22	5.000	<input type="radio"/>
27.000	27.000	7.50	27	6.000	<input type="radio"/>
32.000	32.000	9.00	32	8.000	<input type="radio"/>
50.000	50.000	11.00	40/50	8.000	<input type="radio"/>
					<input type="radio"/>
					<input type="radio"/>
					<input type="radio"/>
					<input type="radio"/>
					<input type="radio"/>
					<input type="radio"/>
					<input type="radio"/>
					<input type="radio"/>
					<input type="radio"/>
					<input type="radio"/>
					<input type="radio"/>
					<input type="radio"/>
					<input type="radio"/>

- bright
- steam tempered
- nitrided
- TiAlN
- TiAlN nanoA
- Carbo
- TiN

# Draw-off nuts



**Guhring no.** 1435

**P (N/mm<sup>2</sup>)**

**M**

**K**

**N**

**S**

**H (HRC)**

**Surface finish**

**Discount group**

105

High speed steel reamers

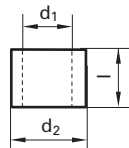

Code no.	d1	l	d2	Availability
	mm	mm		
13.000	13.000	14.00	23.000	<input type="radio"/>
16.000	16.000	16.00	27.000	<input type="radio"/>
19.000	19.000	18.00	32.000	<input type="radio"/>
22.000	22.000	20.00	39.000	<input type="radio"/>
27.000	27.000	21.00	46.000	<input type="radio"/>
32.000	32.000	27.00	56.000	<input type="radio"/>
40.000	40.000	29.00	65.000	<input type="radio"/>
				<input type="radio"/>
				<input type="radio"/>
				<input type="radio"/>
				<input type="radio"/>
				<input type="radio"/>
				<input type="radio"/>
				<input type="radio"/>
				<input type="radio"/>
				<input type="radio"/>
				<input type="radio"/>
				<input type="radio"/>
				<input type="radio"/>

- bright
- steam tempered
- nitrided
- A** TiAlN
- a** TiAlN nanoA
- Cb** Carbo
- S** TiN

# Driving collars



High speed steel reamers

**Guhring no.** 1436

**P (N/mm<sup>2</sup>)**

**M**

**K**

**N**

**S**

**H (HRC)**

**Surface finish**

**Discount group**

105

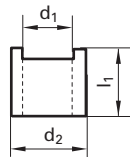

Code no.	d1	l1	d2	Availability
	mm	mm		
13.000	13.000	21.00	23.000	<input type="radio"/>
16.000	16.000	23.00	27.000	<input type="radio"/>
19.000	19.000	28.00	32.000	<input type="radio"/>
22.000	22.000	30.00	39.000	<input type="radio"/>
27.000	27.000	35.00	46.000	<input type="radio"/>
32.000	32.000	42.00	56.000	<input type="radio"/>
40.000	40.000	45.00	65.000	<input type="radio"/>
				<input type="radio"/>
				<input type="radio"/>
				<input type="radio"/>
				<input type="radio"/>
				<input type="radio"/>
				<input type="radio"/>
				<input type="radio"/>
				<input type="radio"/>
				<input type="radio"/>
				<input type="radio"/>
				<input type="radio"/>

- bright
- steam tempered
- nitrided
- TiAlN
- TiAlN nanoA
- Carbo
- TiN



Taper reamers

# TAPER REAMERS





# Taper reamers

Standard	Form	Tool illustration	Tool material	Surface finish	d1	Guhring no.	Discount group	Standard range page
----------	------	-------------------	---------------	----------------	----	-------------	----------------	---------------------

## Machine taper reamers

DIN 2179		HSS-E	○	1.000 - 30.000	410	105	87
DIN 2180		HSS-E	○	5.000 - 50.000	411	105	88

## Hand taper reamers

DIN 9	A		HSS	○	1.000 - 30.000	428	105	89
DIN 9	B		HSS	○	1.500 - 30.000	429	105	89
G			HSS	○	3.000 - 23.000	1433	105	90

Taper reamers

○ bright

● steam tempered

● nitrided

● TiAlN

● TiAlN nanoA

● Carbo

● TiN

# Machine taper reamers

HSS-E

DIN  
2179

Cyl



with taper 1:50 for the reaming of holes to suit taper pins to DIN 1, 258, 7977 and 7978  
 ≤ Ø 4.00 mm with external centres on both ends  
 > Ø 4.00 mm with internal centres on both ends  
 ≤ Ø 1.50 mm to Guhring Standard  
 With tang to DIN 1809

For pre-machining we recommend taper pin drills Guhring no. 531 and 532. However, the pre-drilled hole can also be cylindrical or stepped.

<b>Guhring no.</b>	<b>410</b>
<b>P (N/mm<sup>2</sup>)</b>	<b>1000</b>
<b>M</b>	
<b>K</b>	●
<b>N</b>	●
<b>S</b>	
<b>H (HRC)</b>	
<b>Surface finish</b>	○
<b>Discount group</b>	<b>105</b>

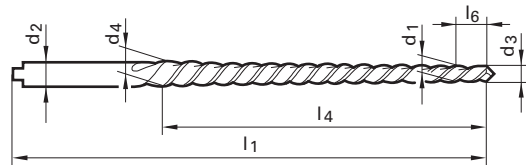

Taper reamers

Code no.	d1	d2	d3	d4	l1	l4	l6		Unit price in €
	mm	mm	mm	mm	mm	mm	mm		
1.000	1.000	1.400	0.900	1.460	60.00	33.00	5.00	2	<b>54.00</b>
1.500	1.500	2.100	1.400	2.140	70.00	37.00	5.00	2	<b>33.50</b>
2.000	2.000	3.150	1.900	2.860	86.00	48.00	5.00	3	<b>34.00</b>
2.500	2.500	3.150	2.400	3.360	86.00	48.00	5.00	3	<b>42.50</b>
3.000	3.000	4.000	2.900	4.060	100.00	58.00	5.00	3	<b>37.50</b>
4.000	4.000	5.000	3.900	5.260	112.00	68.00	5.00	3	<b>37.50</b>
5.000	5.000	6.300	4.900	6.360	122.00	73.00	5.00	3	<b>38.00</b>
6.000	6.000	8.000	5.900	8.000	160.00	105.00	5.00	3	<b>44.00</b>
6.500	6.500	8.500	6.400	8.780	188.00	119.00	5.00	3	<b>57.00</b>
8.000	8.000	10.000	7.900	10.800	207.00	145.00	5.00	3	<b>65.00</b>
10.000	10.000	12.500	9.900	13.400	245.00	175.00	5.00	3	<b>83.00</b>
12.000	12.000	16.000	11.800	16.000	290.00	210.00	10.00	3	<b>104.00</b>
14.000	14.000	17.000	13.800	17.680	289.00	194.00	10.00	3	161.00
30.000	30.000	35.000	29.700	36.100	475.00	320.00	15.00	4	730.00

- bright
- steam tempered
- nitrided
- TiAlN
- TiAlN nanoA
- Carbo
- TiN

# Machine taper reamers

HSS-E

DIN 2180



with taper 1:50 for the reaming of holes to suit taper pins to0 DIN 1, 258, 7977 and 7978  
with internal centres on both ends  
Ø 13.00 und 14.00 mm to Guhring standard

For pre-machining we recommend taper pin drills Guhring no. 531 and 532. However, the pre-drilled hole can also be cylindrical or stepped.

<b>Guhring no.</b>	<b>411</b>
<b>P (N/mm<sup>2</sup>)</b>	<b>1000</b>
<b>M</b>	
<b>K</b>	●
<b>N</b>	●
<b>S</b>	
<b>H (HRC)</b>	
<b>Surface finish</b>	○
<b>Discount group</b>	<b>105</b>

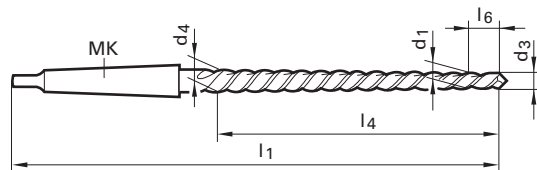

Code no.	d1	MK	d3	d4	l1	l4	l6		Unit price in €
	mm		mm	mm					
5.000	5.000	1	4.900	6.360	155.00	73.00	5.00	3	77.00
6.000	6.000	1	5.900	8.000	187.00	105.00	5.00	3	74.00
8.000	8.000	1	7.900	10.800	227.00	145.00	5.00	3	95.00
10.000	10.000	1	9.900	13.400	257.00	175.00	5.00	3	91.00
12.000	12.000	2	11.800	16.000	315.00	210.00	10.00	3	115.00
13.000	13.000	2	12.800	16.680	295.00	194.00	10.00	3	133.00
14.000	14.000	2	13.800	17.680	295.00	194.00	10.00	3	126.00
16.000	16.000	2	15.800	20.400	335.00	230.00	10.00	3	162.00
20.000	20.000	3	19.800	24.800	377.00	250.00	10.00	3	252.00
25.000	25.000	3	24.700	30.700	427.00	300.00	15.00	3	376.00
30.000	30.000	4	29.700	36.100	475.00	320.00	15.00	4	580.00
40.000	40.000	4	39.700	46.500	495.00	340.00	15.00	6	910.00
50.000	50.000	5	49.700	56.900	550.00	360.00	15.00	8	1440.00

- bright
- steam tempered
- nitrided
- TiAN
- TiAN nanoA
- Carbo
- TiN

Taper reamers









# Hand taper reamers

DIN 9

with taper 1:50 for the reaming of holes to suit taper pins with square to DIN 10  
 Ø 3.50; 4.50; 5.50; 6.50; 7.00; 9.00; 13.00 und 14.00 mm to Guhring standard

For pre-machining we recommend taper pin drills Guhring no. 531 and 532. However, the pre-drilled hole can also be cylindrical or stepped.

	HSS	HSS
		
	<b>A</b>	<b>B</b>
<b>Guhring no.</b>	<b>428</b>	<b>429</b>
<b>P (N/mm²)</b>	<b>900</b>	<b>900</b>
<b>M</b>		
<b>K</b>	●	●
<b>N</b>	●	●
<b>S</b>		
<b>H (HRC)</b>		
<b>Surface finish</b>	○	○
<b>Discount group</b>	<b>105</b>	<b>105</b>
		
		

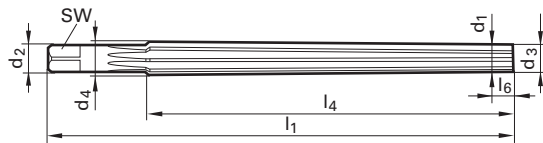

Code no.	d1	d2	d3	d4	l1	l4	l6	SW	
	mm	mm	mm	mm	mm	mm	mm		
1.000	1.000	3.150	0.900	1.460	46.00	28.00	5.00	2.40	3
1.200	1.200	3.150	1.100	1.740	50.00	32.00	5.00	2.40	3
1.500	1.500	3.150	1.400	2.140	57.00	37.00	5.00	2.40	3
2.000	2.000	3.150	1.900	2.860	68.00	48.00	5.00	2.40	3
2.500	2.500	3.150	2.400	3.360	68.00	48.00	5.00	2.40	4
3.000	3.000	4.000	2.900	4.060	80.00	58.00	5.00	3.00	5
3.500	3.500	4.500	3.400	4.660	87.00	63.00	5.00	3.40	5
4.000	4.000	5.000	3.900	5.260	93.00	68.00	5.00	3.80	5
4.500	4.500	5.600	4.400	5.800	95.00	70.00	5.00	4.30	5
5.000	5.000	6.300	4.900	6.360	100.00	73.00	5.00	4.90	5
5.500	5.500	7.100	5.400	7.200	118.00	90.00	5.00	5.50	6
6.000	6.000	8.000	5.900	8.000	135.00	105.00	5.00	6.20	6
6.500	6.500	8.000	6.400	8.600	140.00	110.00	5.00	6.20	6
7.000	7.000	9.000	6.900	9.400	160.00	125.00	5.00	7.00	6
8.000	8.000	10.000	7.900	10.800	180.00	145.00	5.00	8.00	6
9.000	9.000	11.200	8.900	12.100	195.00	160.00	5.00	9.00	6
10.000	10.000	12.500	9.900	13.400	215.00	175.00	5.00	10.00	6
12.000	12.000	14.000	11.800	16.000	255.00	210.00	10.00	11.00	8
13.000	13.000	16.000	12.800	17.000	255.00	210.00	10.00	12.00	8
14.000	14.000	16.000	13.800	18.000	255.00	210.00	10.00	12.00	8
16.000	16.000	18.000	15.800	20.400	280.00	230.00	10.00	14.50	8
20.000	20.000	22.400	19.800	24.800	310.00	250.00	10.00	18.00	8
25.000	25.000	28.000	24.700	30.700	370.00	300.00	15.00	22.00	10
30.000	30.000	31.500	29.700	36.100	400.00	320.00	15.00	24.00	10

Unit price in €	
<b>46.00</b>	
	26.00
<b>42.50</b>	
<b>35.00</b>	
<b>38.50</b>	
<b>40.00</b>	<b>31.50</b>
	<b>41.00</b>
<b>33.50</b>	<b>33.50</b>
	<b>45.50</b>
35.50	<b>35.50</b>
	63.00
<b>42.50</b>	<b>40.50</b>
	61.00
<b>64.00</b>	<b>63.00</b>
<b>63.00</b>	<b>63.00</b>
112.00	<b>93.00</b>
<b>90.00</b>	<b>89.00</b>
122.00	<b>115.00</b>
	<b>130.00</b>
	<b>137.00</b>
<b>169.00</b>	<b>158.00</b>
240.00	<b>206.00</b>
<b>580.00</b>	<b>418.00</b>
	510.00

○ bright    ● steam tempered    ● nitrided    ● A TiAlN    ● a TiAlN nanoA    ● Cb Carbo    ● S TiN

# Hand taper reamers

HSS



with taper 1 : 10 for reaming of conical pre-machined holes  
with square to DIN 10

**Guhring no.** 1433

**P (N/mm<sup>2</sup>)** 1000

**M**

**K**

**N**

**S**

**H (HRC)**

**Surface finish**

**Discount group**

105



Taper reamers

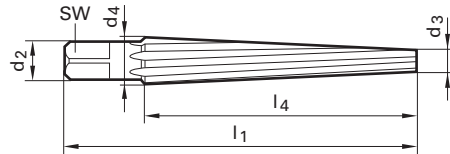

Code no.	d2	d3	d4	l1	l4	SW	
	mm	mm	mm	mm	mm		
3.000	8.000	3.000	10.000	100.00	70.00	6.20	5
5.000	13.000	5.000	15.000	140.00	100.00	10.00	7
10.000	21.000	10.000	25.000	195.00	150.00	16.00	9
15.000	30.000	15.000	35.000	250.00	200.00	24.00	11
23.000	40.000	23.000	45.000	275.00	220.00	32.00	11

Unit price in €
68.00
80.00
162.00
386.00
530.00

○ bright    ● steam tempered    ● nitrided    ● TiAIN    ● TiAIN nanoA    ● Carbo    ● TiN







High speed steel  
hand reamers

# HIGH SPEED STEEL HAND REAMERS

# High speed steel hand reamers

Standard	Form	Tool illustration	Tool material	Surface finish	d1	Guhring no.	Discount group	Standard range page
----------	------	-------------------	---------------	----------------	----	-------------	----------------	---------------------

## Hand reamers

DIN 206	A		HSS		2.000 - 49.000	412	105	93
DIN 206	B		HSS		1.400 - 43.000	413	105	93

## Adjustable hand reamers

DIN 859	B		HSS		4.000 - 59.000	415	105	95
---------	---	---	-----	--	----------------	-----	-----	----

## Expanding hand reamers

G			HSS		6.400 - 67.000	416	105	97
---	--	---	-----	--	----------------	-----	-----	----

## Replacement blades for expanding hand reamers

G			HSS		6.400 - 80.000	417	105	98
---	--	---	-----	--	----------------	-----	-----	----

High speed steel hand reamers

 bright  
  steam tempered  
  nitrided  
  TiAlN  
  TiAlN nanoA  
  Carbo  
  TiN

# Hand reamers

HSS

DIN 206

Cyl

with square to DIN 10  
 ≤ Ø 3.75 mm with ext. centres on both ends  
 > Ø 3.75 mm with int. centres on both ends  
 ≤ 1.75 mm to Guhring standard



A



B

<b>Guhring no.</b>	<b>412</b>	<b>413</b>
<b>P (N/mm<sup>2</sup>)</b>	<b>900</b>	<b>900</b>
<b>M</b>		
<b>K</b>	<b>1</b>	<b>1</b>
<b>N</b>	•	•
<b>S</b>		
<b>H (HRC)</b>		
<b>Surface finish</b>	○	○
<b>Discount group</b>	<b>105</b>	<b>105</b>
	<b>H7</b>	<b>H7</b>

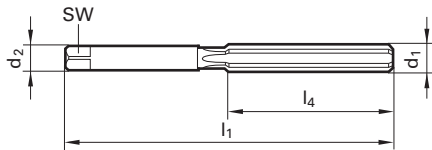

High speed steel  
hand reamers

Code no.	d1	d2	l1	l4	SW	
	mm	mm	mm	mm		
1.400	1.400	1.400	41.00	20.00	1.12	3
1.500	1.500	1.500	41.00	20.00	1.12	3
2.000	2.000	2.000	50.00	25.00	1.60	4
2.200	2.200	2.200	54.00	27.00	1.80	4
2.500	2.500	2.500	58.00	29.00	2.10	4
3.000	3.000	3.000	62.00	31.00	2.40	6
3.200	3.200	3.200	66.00	33.00	2.40	6
3.500	3.500	3.500	71.00	35.00	2.70	6
4.000	4.000	4.000	76.00	38.00	3.00	6
4.500	4.500	4.500	81.00	41.00	3.40	6
5.000	5.000	5.000	87.00	44.00	3.80	6
5.500	5.500	5.500	93.00	47.00	4.30	6
6.000	6.000	6.000	93.00	47.00	4.90	6
6.500	6.500	6.500	100.00	50.00	4.90	6
7.000	7.000	7.000	107.00	54.00	5.50	6
7.500	7.500	7.500	107.00	54.00	6.20	6
8.000	8.000	8.000	115.00	58.00	6.20	6
8.500	8.500	8.500	115.00	58.00	7.00	6
9.000	9.000	9.000	124.00	62.00	7.00	6
9.500	9.500	9.500	124.00	62.00	8.00	6
10.000	10.000	10.000	133.00	66.00	8.00	6
10.500	10.500	10.500	133.00	66.00	8.00	6
11.000	11.000	11.000	142.00	71.00	9.00	6
11.500	11.500	11.500	142.00	71.00	9.00	6
12.000	12.000	12.000	152.00	76.00	9.00	6
12.500	12.500	12.500	152.00	76.00	10.00	6
13.000	13.000	13.000	152.00	76.00	10.00	6
14.000	14.000	14.000	163.00	81.00	11.00	8
15.000	15.000	15.000	163.00	81.00	12.00	8
15.500	15.500	15.500	175.00	87.00	12.00	8

Unit price in €	
	<b>34.00</b>
	31.50
<b>29.00</b>	<b>24.00</b>
<b>36.00</b>	<b>33.50</b>
<b>30.50</b>	<b>27.50</b>
<b>25.50</b>	<b>24.00</b>
37.00	38.50
<b>36.00</b>	<b>36.00</b>
<b>27.50</b>	<b>20.50</b>
36.00	<b>29.50</b>
<b>32.00</b>	<b>23.50</b>
36.50	<b>29.00</b>
<b>24.50</b>	<b>23.00</b>
	<b>27.50</b>
34.00	<b>26.50</b>
	<b>36.00</b>
<b>29.00</b>	<b>27.00</b>
	<b>35.00</b>
<b>38.50</b>	<b>32.00</b>
43.50	<b>39.50</b>
<b>34.00</b>	<b>30.00</b>
	44.50
46.50	<b>39.50</b>
	<b>50.00</b>
<b>37.50</b>	<b>35.00</b>
	<b>61.00</b>
	<b>55.00</b>
<b>69.00</b>	<b>56.00</b>
74.00	<b>64.00</b>
108.00	

○ bright    ● steam tempered    ● nitrided    ● TiAlN    ● TiAlN nanoA    ● Carbo    ● TiN

# Hand reamers

HSS

DIN 206

Cyl

with square to DIN 10  
 $\leq \varnothing 3.75$  mm with ext. centres on both ends  
 $> \varnothing 3.75$  mm with int. centres on both ends  
 $\leq 1.75$  mm to Guhring standard



A



B

<b>Guhring no.</b>	<b>412</b>	<b>413</b>
<b>P (N/mm<sup>2</sup>)</b>	<b>900</b>	<b>900</b>
<b>M</b>		
<b>K</b>	<b>1</b>	<b>1</b>
<b>N</b>	•	•
<b>S</b>		
<b>H (HRC)</b>		
<b>Surface finish</b>	○	○
<b>Discount group</b>	<b>105</b>	<b>105</b>
	Ⓜ <b>H7</b>	Ⓜ <b>H7</b>

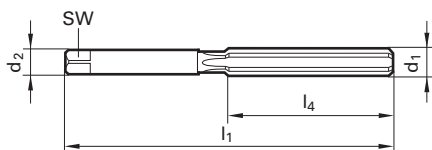

High speed steel hand reamers

Code no.	d1	d2	l1	l4	SW	
	mm	mm	mm	mm		
16.000	16.000	16.000	175.00	87.00	12.00	8
16.500	16.500	16.500	175.00	87.00	13.00	8
17.000	17.000	17.000	175.00	87.00	13.00	8
18.000	18.000	18.000	188.00	93.00	14.50	8
19.000	19.000	19.000	188.00	93.00	14.50	8
20.000	20.000	20.000	201.00	100.00	16.00	8
21.000	21.000	21.000	201.00	100.00	16.00	8
22.000	22.000	22.000	215.00	107.00	18.00	8
24.000	24.000	24.000	231.00	115.00	18.00	8
25.000	25.000	25.000	231.00	115.00	20.00	8
28.000	28.000	28.000	247.00	124.00	22.00	10
30.000	30.000	30.000	247.00	124.00	24.00	10
31.000	31.000	31.000	265.00	133.00	24.00	10
32.000	32.000	32.000	265.00	133.00	24.00	10
33.000	33.000	33.000	265.00	133.00	26.00	10
34.000	34.000	34.000	284.00	142.00	26.00	10
35.000	35.000	35.000	284.00	142.00	29.00	10
38.000	38.000	38.000	305.00	152.00	29.00	10
38.100	38.100	38.100	305.00	152.00	29.00	10
40.000	40.000	40.000	305.00	152.00	32.00	10
43.000	43.000	43.000	326.00	163.00	35.00	12
44.000	44.000	44.000	326.00	163.00	32.00	12
46.000	46.000	46.000	326.00	163.00	35.00	12
49.000	49.000	49.000	347.00	174.00	39.00	12

Unit price in €	
<b>67.00</b>	<b>62.00</b>
	<b>90.00</b>
85.00	<b>68.00</b>
	<b>77.00</b>
	<b>83.00</b>
<b>92.00</b>	<b>78.00</b>
136.00	<b>117.00</b>
114.00	<b>93.00</b>
	<b>110.00</b>
130.00	<b>107.00</b>
<b>178.00</b>	<b>153.00</b>
	<b>151.00</b>
	226.00
	<b>178.00</b>
	<b>260.00</b>
	<b>260.00</b>
	<b>216.00</b>
	<b>316.00</b>
360.00	
	<b>286.00</b>
	<b>640.00</b>
452.00	
510.00	
<b>730.00</b>	

○ bright    ● steam tempered    ● nitrided    ● TiAlN    ● TiAlN nanoA    ● Carbo    ● TiN

# Adjustable hand reamers

HSS

DIN 859

Cyl

with square to DIN 10  
with internal centres on both ends

The hand reamers are ground to nom. size and not for hole tolerance zone H7.  
The adjustment range is 1/100 of the nom. diameter, i. e. for Ø 10.00 mm approx. 0.1 mm.  
From Ø 6.50 mm the adjustment is via a lock nut.

<b>Guhring no.</b>	<b>415</b>
<b>P (N/mm<sup>2</sup>)</b>	<b>900</b>
<b>M</b>	
<b>K</b>	<b>1</b>
<b>N</b>	•
<b>S</b>	
<b>H (HRC)</b>	
<b>Surface finish</b>	○
<b>Discount group</b>	<b>105</b>

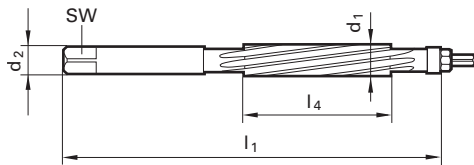

High speed steel hand reamers

Code no.	d1	d2	l1	l4	SW	
	mm	mm	mm	mm		
4.000	4.000	4.000	76.00	24.00	3.00	6
5.000	5.000	5.000	87.00	30.00	3.80	6
5.500	5.500	5.500	93.00	33.00	4.30	6
6.000	6.000	6.000	93.00	33.00	4.90	6
7.000	7.000	7.000	107.00	38.00	5.50	9
8.000	8.000	8.000	115.00	42.00	6.20	9
9.000	9.000	9.000	124.00	46.00	7.00	9
10.000	10.000	10.000	133.00	50.00	8.00	9
11.000	11.000	11.000	142.00	51.00	9.00	9
12.000	12.000	12.000	152.00	56.00	9.00	9
12.500	12.500	12.500	152.00	56.00	10.00	9
13.000	13.000	13.000	152.00	56.00	10.00	9
14.000	14.000	14.000	163.00	61.00	11.00	9
15.000	15.000	15.000	163.00	61.00	12.00	9
16.000	16.000	16.000	175.00	67.00	12.00	9
17.000	17.000	17.000	175.00	67.00	13.00	9
18.000	18.000	18.000	188.00	68.00	14.50	9
19.000	19.000	19.000	188.00	68.00	14.50	9
20.000	20.000	20.000	201.00	75.00	16.00	9
21.000	21.000	21.000	201.00	75.00	16.00	12
22.000	22.000	22.000	215.00	82.00	18.00	12
24.000	24.000	24.000	231.00	85.00	18.00	12
25.000	25.000	25.000	231.00	85.00	20.00	12
26.000	26.000	26.000	231.00	85.00	20.00	12
28.000	28.000	28.000	247.00	94.00	22.00	12
29.000	29.000	29.000	247.00	94.00	22.00	12
30.000	30.000	30.000	247.00	94.00	24.00	12
31.000	31.000	31.000	265.00	99.00	24.00	12
32.000	32.000	32.000	265.00	99.00	24.00	12
33.000	33.000	33.000	265.00	99.00	26.00	12

Unit price in €
<b>75.00</b>
<b>83.00</b>
84.00
<b>88.00</b>
<b>123.00</b>
<b>106.00</b>
<b>136.00</b>
<b>108.00</b>
<b>169.00</b>
<b>126.00</b>
177.00
<b>177.00</b>
<b>157.00</b>
<b>153.00</b>
<b>199.00</b>
216.00
254.00
<b>240.00</b>
<b>212.00</b>
280.00
<b>306.00</b>
<b>338.00</b>
<b>292.00</b>
276.00
346.00
458.00
<b>380.00</b>
478.00
510.00
<b>640.00</b>

○ bright

● steam tempered

● nitrided

● TiAlN

● TiAlN nanoA

● Carbo

● TiN

# Adjustable hand reamers

HSS

DIN 859

Cyl



B

left hand spiral flutes  
with square to DIN 10  
with internal centres on both ends

The hand reamers are ground to nom. size and not for hole tolerance zone H7.  
The adjustment range is 1/100 of the nom. diameter, i. e. for Ø 10.00 mm approx. 0.1 mm.  
From Ø 6.50 mm the adjustment is via a lock nut.

<b>Guhring no.</b>	<b>415</b>
<b>P (N/mm<sup>2</sup>)</b>	<b>900</b>
<b>M</b>	
<b>K</b>	<b>1</b>
<b>N</b>	●
<b>S</b>	
<b>H (HRC)</b>	
<b>Surface finish</b>	○
<b>Discount group</b>	<b>105</b>



High speed steel  
hand reamers

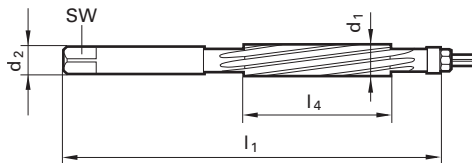

Code no.	d1	d2	l1	l4	SW	
	mm	mm	mm	mm		
38.000	38.000	38.000	305.00	111.00	29.00	12
41.000	41.000	41.000	305.00	111.00	32.00	12
43.000	43.000	43.000	326.00	120.00	35.00	12
46.000	46.000	46.000	326.00	120.00	35.00	12
47.000	47.000	47.000	326.00	120.00	39.00	12
49.000	49.000	49.000	347.00	131.00	39.00	12
51.000	51.000	51.000	347.00	131.00	39.00	16
54.000	54.000	54.000	367.00	131.00	44.00	16
58.000	58.000	58.000	367.00	131.00	44.00	16
59.000	59.000	59.000	367.00	131.00	49.00	16

Unit price in €
<b>640.00</b>
960.00
1220.00
1460.00
1240.00
1440.00
1360.00
1360.00
1700.00
1680.00

- bright
- steam tempered
- nitrided
- TiAlN
- TiAlN nanoA
- Carbo
- TiN



# Expanding hand reamers

HSS



with wide adjustment range  
with square to DIN 10  
with internal centres on both ends

The quickly adjustable hand reamers are especially suitable for maintenance and repairs.

<b>Guhring no.</b>	<b>416</b>
<b>P (N/mm<sup>2</sup>)</b>	<b>900</b>
<b>M</b>	
<b>K</b>	<b>1</b>
<b>N</b>	•
<b>S</b>	
<b>H (HRC)</b>	
<b>Surface finish</b>	○
<b>Discount group</b>	<b>105</b>

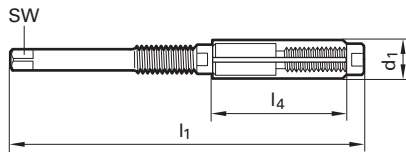

High speed steel  
hand reamers

Code no.	d1	from d1	to d1	l1	l4	SW	
	mm	mm	mm	mm	mm		
6.400	6.400	6.400	7.200	110.00	32.00	3.00	4
7.200	7.200	7.200	8.000	110.00	32.00	3.40	4
8.000	8.000	8.000	9.000	115.00	34.00	3.80	5
9.000	9.000	9.000	10.000	115.00	34.00	4.30	5
10.000	10.000	10.000	11.000	115.00	34.00	4.90	5
11.000	11.000	11.000	12.000	125.00	35.00	4.90	5
12.000	12.000	12.000	13.500	135.00	41.00	6.20	5
13.500	13.500	13.500	15.500	146.00	50.00	7.00	5
15.500	15.500	15.500	18.000	166.00	60.00	8.00	5
18.000	18.000	18.000	21.000	178.00	65.00	9.00	5
21.000	21.000	21.000	24.000	195.00	76.00	11.00	5
24.000	24.000	24.000	27.500	218.00	82.00	12.00	5
27.500	27.500	27.500	31.500	245.00	86.00	14.50	5
31.500	31.500	31.500	37.000	280.00	98.00	18.00	6
37.000	37.000	37.000	45.000	325.00	108.00	20.00	6
45.000	45.000	45.000	55.000	370.00	118.00	26.00	6
55.000	55.000	55.000	65.000	400.00	125.00	32.00	6
67.000	67.000	67.000	80.000	435.00	140.00	39.00	8

Unit price in €
114.00
114.00
113.00
125.00
119.00
125.00
135.00
149.00
153.00
169.00
202.00
216.00
250.00
346.00
448.00
630.00
770.00
960.00

- bright
- steam tempered
- nitrided
- TiAlN
- TiAlN nanoA
- Carbo
- TiN

# Replacement blades for expanding hand reamers

HSS



<b>Guhring no.</b>	<b>417</b>
<b>P (N/mm<sup>2</sup>)</b>	<b>1000</b>
<b>M</b>	
<b>K</b>	<b>1</b>
<b>N</b>	•
<b>S</b>	
<b>H (HRC)</b>	
<b>Surface finish</b>	○
<b>Discount group</b>	<b>105</b>



High speed steel  
hand reamers



Code no.	d1	from d1	to d1	l4	Unit price in €
	mm	mm	mm	mm	
6.400	6.400	6.400	7.200	32.00	74.00
7.200	7.200	7.200	8.000	32.00	70.00
8.000	8.000	8.000	9.000	34.00	68.00
9.000	9.000	9.000	10.000	34.00	77.00
10.000	10.000	10.000	11.000	34.00	88.00
11.000	11.000	11.000	12.000	35.00	88.00
12.000	12.000	12.000	13.500	41.00	78.00
13.500	13.500	13.500	15.500	50.00	94.00
15.500	15.500	15.500	18.000	60.00	105.00
18.000	18.000	18.000	21.000	65.00	92.00
21.000	21.000	21.000	24.000	76.00	145.00
24.000	24.000	24.000	27.500	82.00	143.00
27.500	27.500	27.500	31.500	86.00	162.00
31.500	31.500	31.500	37.000	98.00	236.00
37.000	37.000	37.000	45.000	108.00	280.00
45.000	45.000	45.000	55.000	118.00	376.00
55.000	55.000	55.000	65.000	125.00	478.00
65.000	65.000	65.000	67.000	140.00	720.00
67.000	67.000	67.000	80.000	140.00	660.00
80.000	80.000	80.000	95.000	155.00	850.00

○ bright    ● steam tempered    ● nitrided    ● TiAIN    ● TiAIN nanoA    ● Carbo    ● TiN



Pilot tools

# PILOT TOOLS



This high-performance tooling system is both suitable for various machining tasks and a wide variety of materials.

**The features:**

- Highly precise, special shaped pocket seat for excellent insert guidance
- Precision-ground insert
- Radial screw for  $\mu\text{m}$ -accurate adjustment
- Easy adjustment while inserts are clamped
- Easy handling
- Large range of adjustment

**Advantages in the use of these tools:**

Easy adjustment while inserts are clamped...



Simply adjusting to desired bore tolerance reduces unproductive handling operations

The second cutting edge is embedded in the pocket seat



Avoids destruction of the second cutting edge by evacuated chips

Low costs in stock inventory due to large diameter coverage of tools



Low capital requirement

**Example: Correcting off-set**

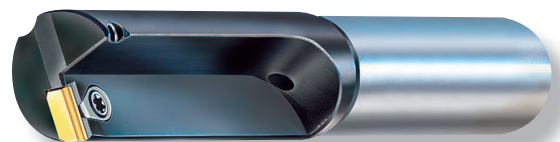
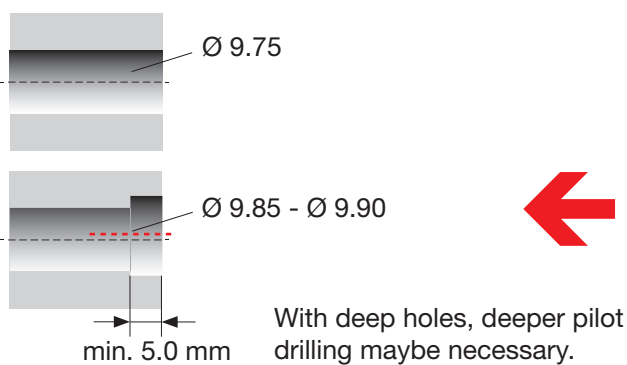

Off-set of pilot hole to reamer position  
Correction with milling cutter or Hollfelder fine machining tool.

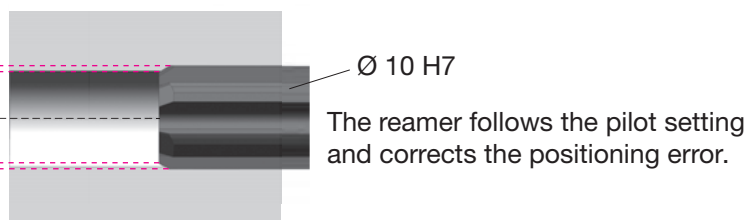

Hollfelder-Gühring  
pilot tools



### Additional design features:

The adjustable pilot tools with tapered screw have a robust clamping element located in the chip flute, large chip flutes and an internal coolant supply. These aforementioned design elements are responsible for an excellent chip evacuation even when long-chipping material is machined.

Based on our standard tools we also design and manufacture customer specific solutions for your individual machining requirements.

### The radial fine adjustment with radial screw

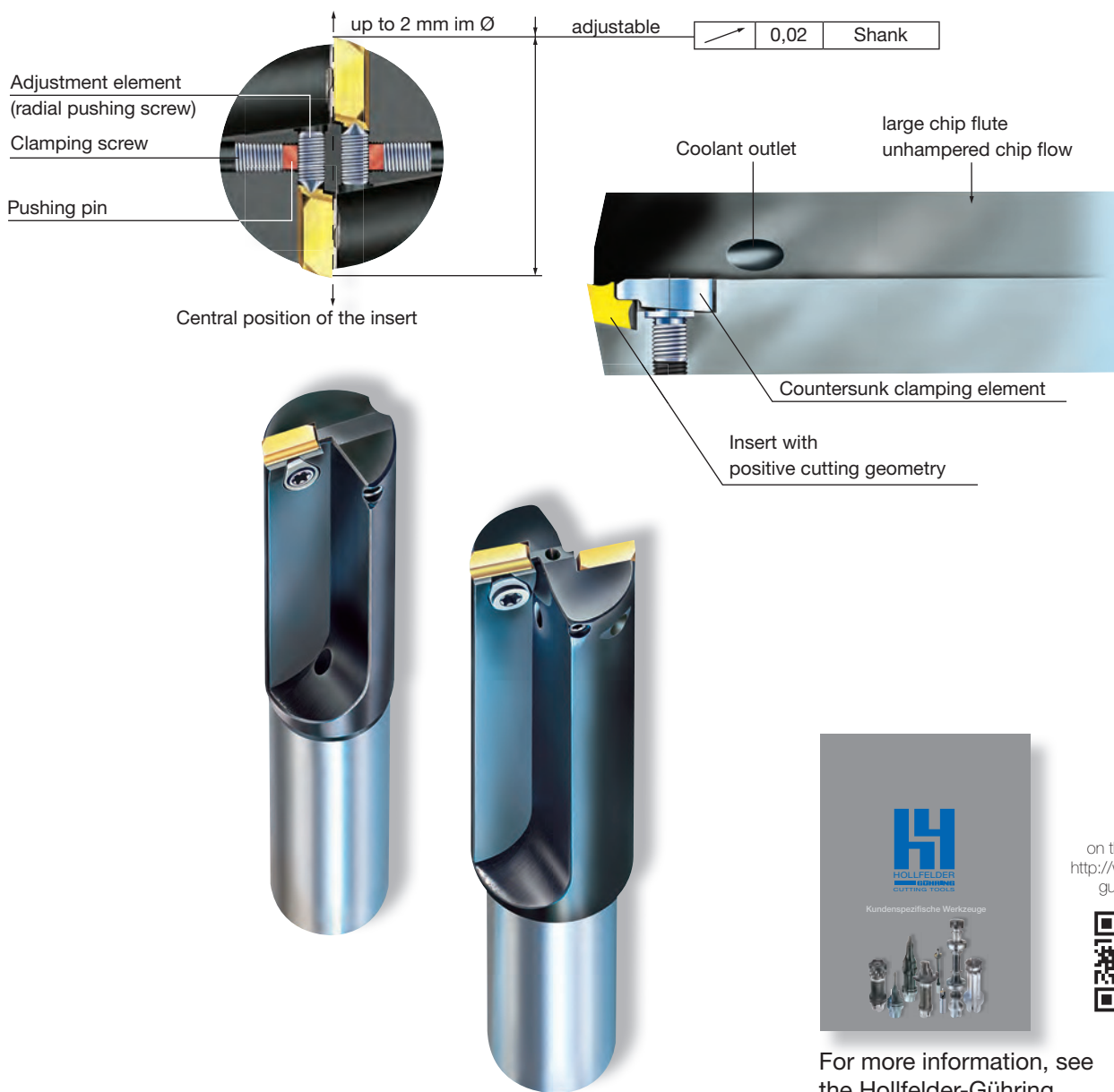

Hollfelder-Gühring  
pilot tools



Visit us  
on the Internet at  
[http://www.hollfelder-guehring.de/!](http://www.hollfelder-guehring.de/)



For more information, see the Hollfelder-Gühring catalog „Special tooling for customer applications“.



# 1-fluted $\varnothing 7 - 20$ mm with internal cooling, shank to DIN 1835 A

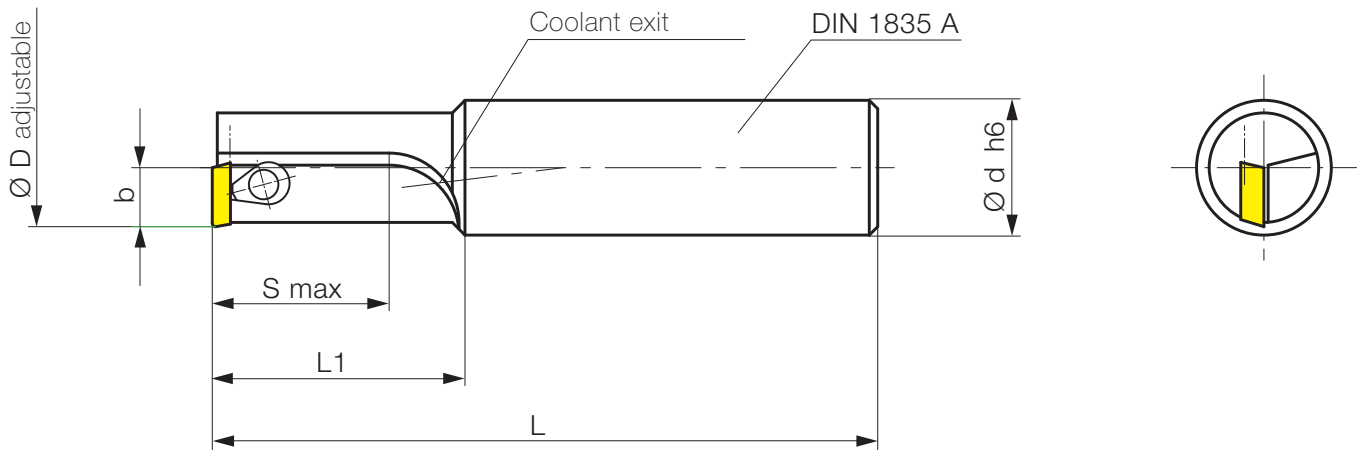

Part nr.	Code	Drawing nr.	b	$\varnothing D$	$\varnothing d$	S	L <sup>1</sup>	L	inserts	Availability
			mm	mm	mm	mm	mm	mm		
20023	7,000	H 1035-0700 1116 R	3,9	7 - 8	16	11	19	67	W 1035-... L	●
20023	8,000	H 1035-0800 1216 R	3,9	8 - 9	16	12	20	68	W 1035-... L	●
20023	9,000	H 1035-0900 1416 R	3,9	9 - 10	16	14	22	70	W 1035-... L	●
20023	10,000	H 2850-1000 1516 R	5	10 - 11	16	15	25	73	W 2850-... L	●
20023	11,000	H 2850-1100 1716 R	5	11 - 12	16	17	27	75	W 2850-... L	●
20023	12,000	H 2850-1200 1816 R	5	12 - 13	16	18	28	76	W 2850-... L	●
20023	13,000	H 2850-1300 2016 R	5	13 - 14	16	20	30	78	W 2850-... L	●
20023	14,000	H 3570-1400 2116 R	7	14 - 16	16	21	25	73	W 357-...L	●
20023	16,000	H 3570-1600 2416 R	7	16 - 18	16	24	27	75	W 357-...L	●
20023	18,000	H 3570-1800 2716 R	7	18 - 20	16	27	28	76	W 357-...L	●

Order example: 1 piece H 1035-0700 2016 R = order no.: 20023 7,000

Hollfelder-Gühring  
pilot tools



Visit us  
on the Internet at  
[http://www.hollfelder-guehring.de/!](http://www.hollfelder-guehring.de/)



For more information,  
see the Hollfelder-Gühring  
main catalog.



## 2-fluted Ø 10 - 40 mm with internal cooling, shank to DIN 1835 A

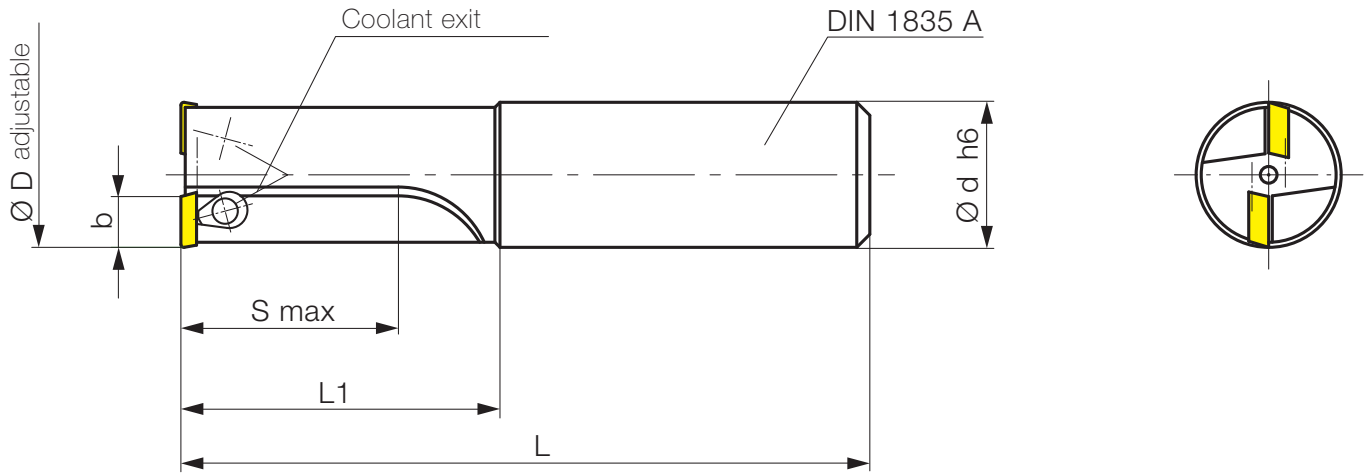

Part nr.	Code	Drawing nr.	b	Ø D	Ø d	S	L <sup>1</sup>	L	inserts	Availability
			mm	mm	mm	mm	mm	mm		
20024	10,000	H 1035-1000 1516 R	3,9	10 - 11	16	15	25	73	W 1035-... L	●
20024	11,000	H 1035-1100 1716 R	3,9	11 - 12	16	17	27	75	W 1035-... L	●
20024	12,000	H 1035-1200 1816 R	3,9	12 - 13	16	18	28	76	W 1035-... L	●
20024	13,000	H 1035-1300 2016 R	3,9	13 - 14	16	20	30	78	W 1035-... L	●
20024	14,000	H 2850-1400 2116 R	5	14 - 15	16	21	31	79	W 2850-... L	●
20024	15,000	H 2850-1500 2316 R	5	15 - 16	16	23	33	81	W 2850-... L	●
20024	16,000	H 2850-1600 2416 R	5	16 - 17	16	24	34	82	W 2850-... L	●
20024	17,000	H 2850-1700 2616 R	5	17 - 18	16	26	36	84	W 2850-... L	●
20024	18,000	H 2850-1800 2716 R	5	18 - 19	16	27	37	85	W 2850-... L	●
20024	19,000	H 2850-1900 2916 R	5	19 - 20	16	29	39	87	W 2850-... L	●
20024	20,000	H 3570-2000 3020 R	7	20 - 22	20	30	45	95	W 357-...L	●
20024	22,000	H 3570-2200 3320 R	7	22 - 24	20	33	48	98	W 357-...L	●
20024	24,000	H 3570-2400 3620 R	7	24 - 26	20	36	51	101	W 357-...L	●
20024	26,000	H 4090-2600 3925 R	9	26 - 28	25	39	54	110	W 409-...L	●
20024	28,000	H 4090-2800 4225 R	9	28 - 30	25	42	57	113	W 409-...L	●
20024	30,000	H 4090-3000 4532 R	9	30 - 32	32	45	63	123	W 409-...L	●
20024	32,000	H 4090-3200 4832 R	9	32 - 34	32	48	66	126	W 409-...L	●
20024	34,000	H 4090-3400 5132 R	9	34 - 36	32	51	69	129	W 409-...L	●
20024	36,000	H 4090-3600 5432 R	9	36 - 38	32	54	72	132	W 409-...L	●
20024	38,000	H 4090-3800 5732 R	9	38 - 40	32	57	75	135	W 409-...L	●

Order example: 1 piece H 1035-1000 1516 R = order no.: 20024 10,000



### Type W 1035-..... L

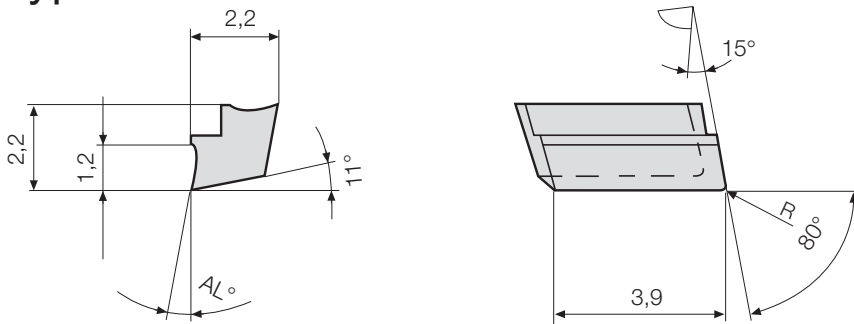

Part nr.	Code	Drawing nr.	R	AL°	Tool material	Workpiece material	Availability
20400	10,351	W 1035-0212 1000 L	0,2	10	G12	cast	●
20402	10,351	W 1035-0212 1000 L	0,2	10	G16	steel	●
20102	10,353	W 1035-0212 1620 L	0,2	16	K10	Alu	●
20112	10,351	W 1035-0200 0000 L	0,2	0	PKD	Alu	●

### Type W 2850-..... L

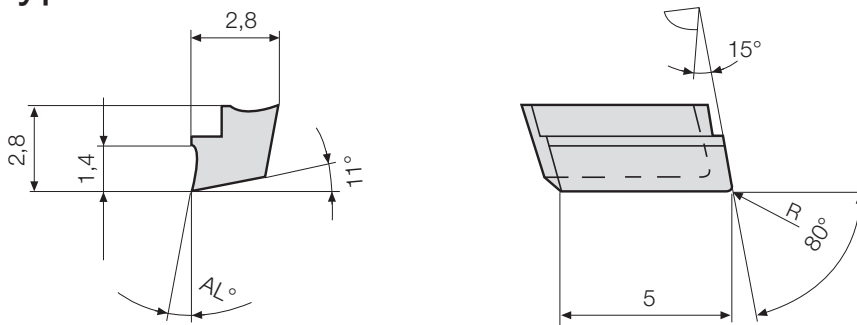

Part nr.	Code	Drawing nr.	R	AL°	Tool material	Workpiece material	Availability
20430	28,500	W 2850-0214 1000 L	0,2	10	G12	cast	●
20432	28,500	W 2850-0214 1000 L	0,2	10	G16	steel	●
20145	28,502	W 2850-0214 1620 L	0,2	16	K10	Alu	●
20155	28,501	W 2850-0200 0000 L	0,2	0	PKD	Alu	●

### Type W 3570-..... L

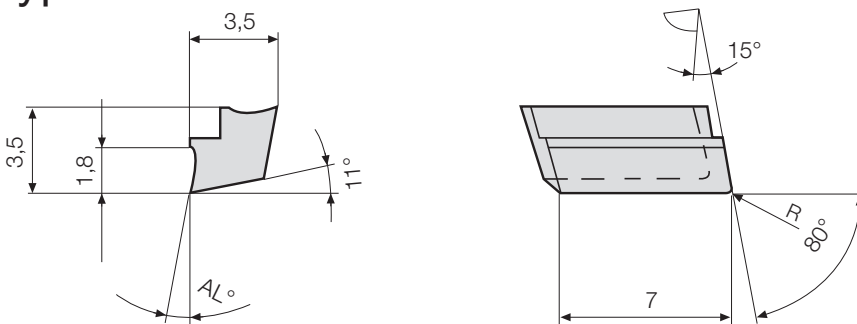

Part nr.	Code	Drawing nr.	R	AL°	Tool material	Workpiece material	Availability
20450	35,700	W 3570-0218 1000 L	0,2	10	G12	cast	●
20452	35,700	W 3570-0218 1000 L	0,2	10	G16	steel	●
20178	35,702	W 3570-0218 1620 L	0,2	16	K10	Alu	●

More geometry and tool material variants of the inserts can be found in Hollfelder-Gühring main catalog.





### Type W 3573-..... L

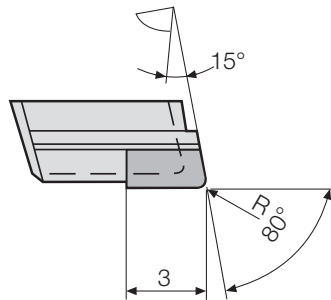
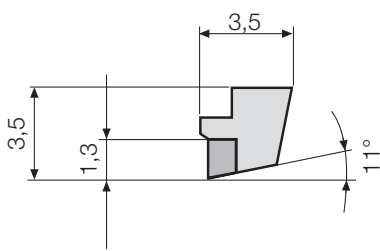

Part nr.	Code	Drawing nr.	R	AL°	Tool material	Workpiece material	Availability
20208	35,731	W 3573-0213 0000 L	0,2	0	PKD	Alu	●

### Type W 4090-..... L

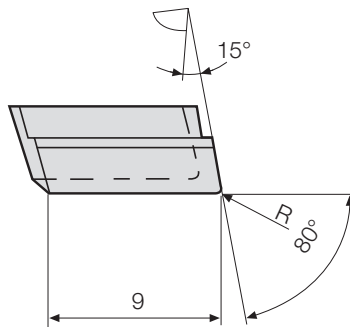
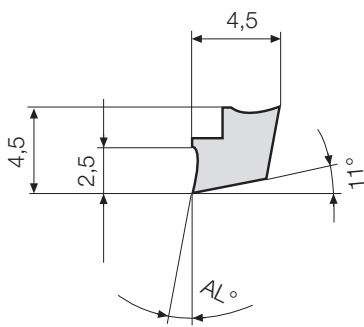

Part nr.	Code	Drawing nr.	R	AL°	Tool material	Workpiece material	Availability
20460	40,900	W 4090-0225 1000 L	0.2	10	G12	cast	●
20462	40,900	W 4090-0225 1000 L	0.2	10	G16	steel	●
20194	40,902	W 4090-0225 1620 L	0.2	16	K10	Alu	●

Hofleider-Guhring  
pilot tools

### Type W 4093-..... L

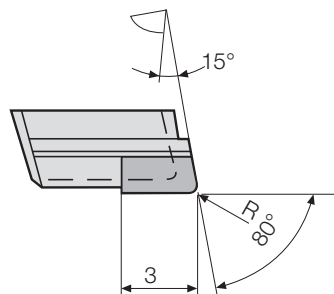
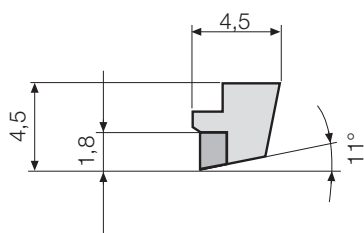

Part nr.	Code	Drawing nr.	R	AL°	Tool material	Workpiece material	Availability
20212	40,931	W 4093-0218 0000 L	0,2	0	PKD	Alu	●



## Adjustment instruction

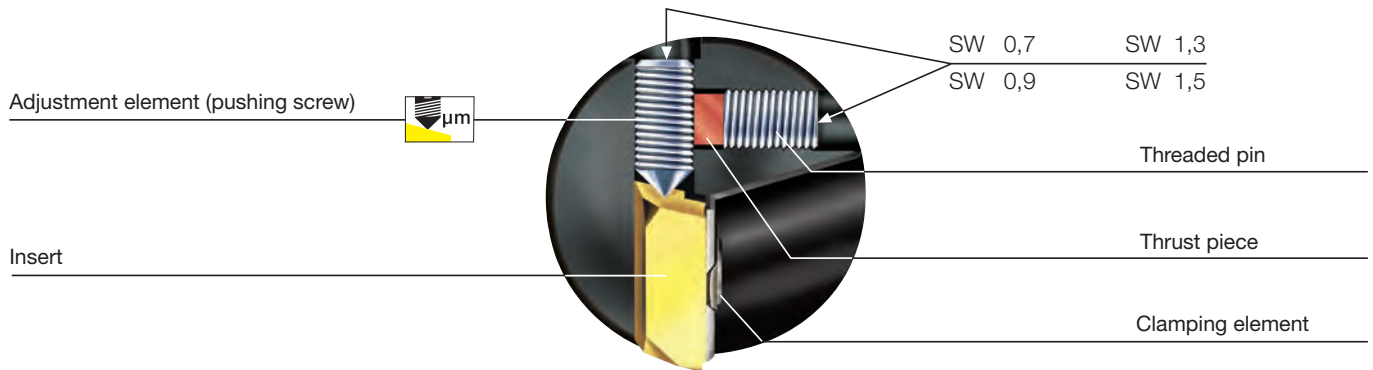

### 1. Changing the insert

#### Disassembly

- Loosen clamping set (1 to 2 turns) and remove the worn insert
- Clean the insert pocket
- Turn out the adjustment element 1 to 2 turns

#### Assembly

- Put a new insert in the pocket seat
- Press insert into the pocket seat, keep under pressure and slightly tighten the clamp set:  
 Torx 5 to 40 Ncm      Torx 6 to 40 Ncm  
 Torx 8 to 100-120 Ncm      Torx 15 to 250-300 Ncm

### 2. Adjustment of the inserts

- Clamp the holder in the presetting device
- Adjust the insert in diameter up to 0.05 mm smaller than target measure
- Tighten the clamp set

We recommend to use our torque wrench:

E 5000 adjustable	20-120 Ncm	E 5001 adjustable	100-600 Ncm
E 5400-5 fixed for Tx 5	45 Ncm	E 5400-6 fixed for Tx 6	70 Ncm
E 5400-8 fixed for Tx 8	140 Ncm	E 5400-15 fixed for Tx 15	345 Ncm

- Adjust insert to the required machining diameter (It is not necessary to retighten the clamping set!)

### Torque for clamping elements

Tool body Series	Clamping set	Torque (Ncm)	Torx size
H 1035	E 1100	45	Tx 5
H 2850	E 1085 / E 1112	70	Tx 6
H 3570	E 1060	140	Tx 8
H 4090	E 1040	345	Tx 15



The cutting data recommendations in the table are guide values

and depend to a high degree on the stability of the machine, fixture and workpiece.

Cutting groups	Material group	Composition / structure	Tensile strength	Hardness	Cutting speed	Recom. cutting grade	Feed rate fz mm/z								
							Insert type								
							W 1035-	W 1730-	W 1733-	W 2850-	W 2853-	W 3570-	W 3573-	W 4090-	W 4093-
1.1		C = 0.1 -0.25 annealed, long cutt.	420	125	100-160	G26/G16	0,02-0,08	0,02-0,08	0,02-0,10	0,04-0,12	0,04-0,12	0,05-0,15	0,05-0,15	0,07-0,20	0,07-0,20
1.2		C = 0.1 -0.25 annealed, short chip	420	125	100-160	↓									
2.1	Unalloyed steel	C = 0.25-0.55 annealed, long cutt.	620	190	90-150										
2.2	Cast steel	C = 0.25-0.55 annealed, short chip	640	190	100-160										
3	Machining steel	C = 0.25 -0.55 tempered	850	250	90-150										
4		C = 0.25 -0.8 annealed	915	270	80-140										
5		C = 0.25 -0.8 tempered	1020	300	75-125										
6		annealed	610	180	90-140										
7	Low-alloy steel	tempered	930	275	60-110										
	Cast steel														
8	Machining steel	tempered	1020	300	60-110										
9		tempered	1190	350	60-100										
10	High-alloy steel	annealed	680	200	60-110										
	Cast steel														
11	High-alloy tool steel	hardened and tempered	1100	325	50-90										
12-13	Stainless steel and cast steel	ferritic/martensitic annealed	680	200	50-90										
		martensitic	810	240	40-80	↓									
14.1	Stainless steel	austenitic quenched	610	180	40-80	G26/G12									
14.2		austenitic/ferritic (duplex)	880	260	40-80	↓									
15	Grey cast iron	perlitic/ferritic		180	110-160	G12/K10									
16		perlitic (martensitic)		260	100-150	↓									
17	Cast iron with nodular cast iron	ferritic		160	80-130	G26/G16/G12									
18		perlitic		250	70-120										
19	Malleable	ferritic		130	90-150	G26/G16									
20		perlitic		230	80-140	↓									
21	Aluminium forging alloys	not heat treatable		60	-1000	K10/PKD									
22		heat treatable/heat treated		100	-800	↓									
23	Aluminium casting alloys	<12% Si not heat treatable		75	-1000	↓									
24		<12% Si heat treatable/heat treated		90	-800	↓									
25		>12% Si not heat treatable		130	-600	PKD									
26	Copper	Machined alloys, Pb >1%		110	70-120	G12/K10									
27	Copper alloys (bronze, brass)	CuZn, CuSnZn		90	70-120	↓									
28		Cu, lead free copper/electrolyte copper		100	70-120	↓									
29	Non metallic materials	Duroplastic			-200	K10/PKD									
30		Reinforced materials			-200	↓									
31	Heat resistant alloys	Fe-based annealed		200	30-50	G26/G16									
32			heat treated		230	30-50	↓								
33			Ni- or Co-based annealed		250	20-40									
34			heat treated		350	20-40									
35			cast		320	20-40	↓								
36	Titanium alloys	Pure titanium	400		20-40	K10									
37			Alpha-beta alloys	1050		20-30	↓								
38	Hardened steels			50-62	80-150	PCBN									
39							↓								

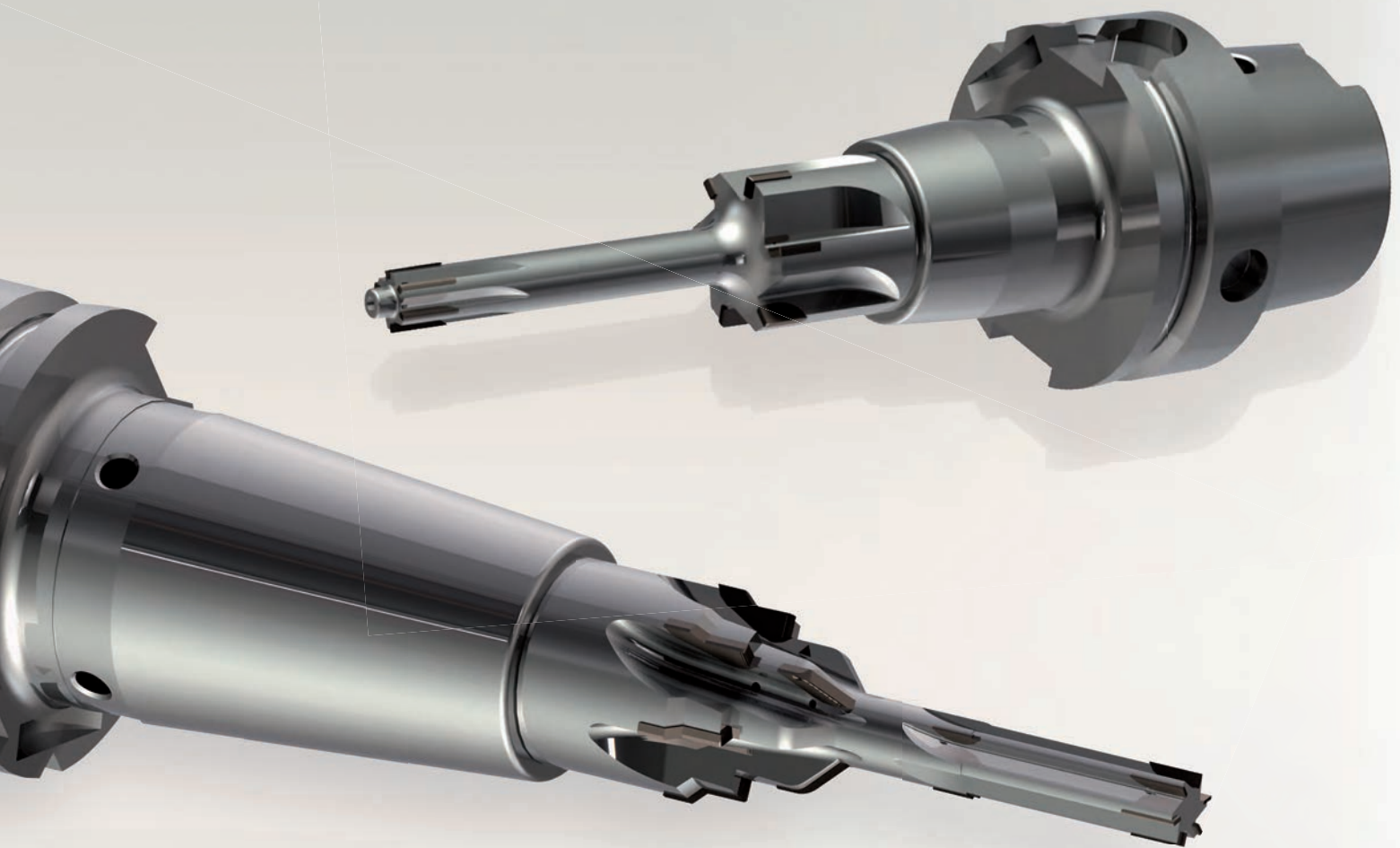

























## PCD reaming tools





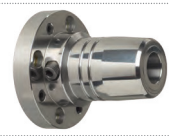





















In addition to our special cermet, carbide and HSS-E reamers we also supply diamond tipped reaming tools designed as a modular system for the pre- and finish machining of valve seats.



# CLAMPING DEVICES

# Clamping devices

Standard	Tool illustration	Dimensions	Guhring no.	Discount group	Standard range page
<b>Module 6x6</b>					
	 alignment adapter HSK-A	HSK-A 63 - HSK-A 100	<b>4723</b>	114	113
	 ISO taper alignment adapter	ISO taper 40	<b>4725</b>	114	114
	 hydraulic chuck flange	module-Ø 70 - Ø 100	<b>4722</b>	114	115
	 shrink fit chuck flange	module-Ø 60 - Ø 100	<b>4717</b>	114	116
	 HPC clamping chuck flange	module-Ø 70 - Ø 100	<b>4714</b>	114	117
	 adaptor flange HSK	HSK-C 32 - HSK-C 100	<b>4363</b>	114	117
	 intermediate sleeves for module flange and alignment adapter	Ø 10.7	<b>4716</b>	114	122
	 angle alignment units for module flange and alignment adapter	for modules 60 - 140	<b>4715</b>	114	122
<b>Module 4x4</b>					
	 alignment adapter HSK-A	HSK-A 63 - HSK-A 100	<b>4297</b>	114	118
	 ISO taper alignment adapter	ISO taper 40	<b>4724</b>	114	118
	 hydraulic chuck flange	module-Ø 70 - Ø 100	<b>4360</b>	114	119
	 shrink fit chuck flange	module-Ø 60 - Ø 100	<b>4760</b>	114	120
	 adaptor flange HSK	HSK-C 32 - HSK-C 100	<b>4713</b>	114	121

Standard	Tool illustration		Dimensions	Guhring no.	Discount group	Standard range page
<b>Module 4x4</b>						
		length adjustment screw for conventional cooling	for HSK-A 40 - 140	<b>4941</b>	114	121
		intermediate sleeves for module flange and alignment adapter	Ø 10.7	<b>4716</b>	114	122
		angle alignment units for module flange and alignment adapter	for modules 60 - 140	<b>4715</b>	114	122
<b>Floating holders</b>						
		with side lock holder	Ø 20 - Ø 32	<b>4167</b>	Net price	124
		short with side lock holder	Ø 20	<b>4169</b>	Net price	124
		Mini with side lock holder	Ø 16	<b>4174</b>	Net price	125
		with ER collet holder	Ø 16 - Ø 40	<b>4098</b>	Net price	125
		VDI DIN 69880-1 with side lock holder	Ø 30 - Ø 50	<b>4117</b>	Net price	126
		VDI DIN 69880-1 with ER collet holder	Ø 30 - Ø 50	<b>4116</b>	Net price	126
		reduction sleeves for floating holder	Ø 20 - Ø 32	<b>4095</b>	Net price	127
		reduction sleeves for short floating holder	Ø 10 - Ø 20	<b>4096</b>	Net price	127
		reduction sleeves for floating holder Mini	Ø 10	<b>4097</b>	Net price	128
		collets er metallic sealed	ER20 - ER32	<b>4175</b>	114	128

Clamping devices

# MODULE TECHNOLOGY AND ADVANTAGES

Pinpoint accurate tool setting. Thanks to closely arranged setting screws for radial and axial adjustment corrections can be made in close proximity to the measuring point. With a wide choice of chucks (hydraulic, shrink fit or HPC) and interfaces such as HSK and SK your module can be perfectly set without a problem.



Clamping devices

## Advantages:

- wobble-free tool setting
- quick  $\mu$ -accurate setting
- optimal setting results for multi-flute PCD/CBN fine machining tools or Guhring's HR 500 high-performance reamer
- reduced settlement properties provides highest accuracy over a long period
- suitable for use in combination with monolythic special tools







# Module 6x6 hydraulic chuck flange

## Product information

- for the highly accurate radial and axial alignment on alignment adaptors or machine spindles
- cooling lubricant without loss and flow-disruption thanks to the use of an intermediate tube
- balancing quality G6.3 / 15,000 rev./min
- for tool shank tolerance h6

## Scope of delivery

- incl. adjustment screw Guhring no. 4941 for conventional cooling
- incl. angular alignment set Guhring no. 4715
- incl. 6 clamping screws
- incl. hexagon chuck key Guhring no. 4912
- order intermediate tube Guhring no. 4716 separately
- for other clamping  $\varnothing$  apply reduction bushes Guhring no. 4368 or 4369
- MQL version on request

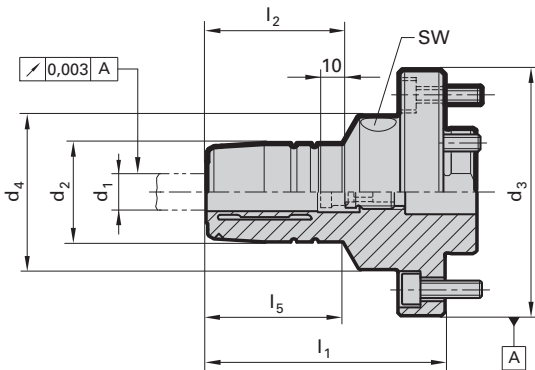

Guhring no. **4722**

Discount group **114**

Module- $\varnothing d_3$ mm	for shank $\varnothing d_1$ h6 mm	$d_2$ mm	$d_4$ mm	$l_1$ mm	$l_2$ mm	$l_5$ mm	incl. setting screw Guh. no. 4941	intermediate sleeve tube Guhring no. 4716	SW	Code no.	Availability
70	12	32	40	75.0	45	45.0	12.100	14.020	4	12.070	●
80	12	32	50	77.5	45	44.0	12.100	14.050	5	12.080	●
80	20	42	50	82.5	50	51.5	20.100	14.040	5	20.080	●
100	32	64	64	103.0	60	84.0	32.100	14.020	6	32.100	●

# Module 6x6 shrink fit chuck flange

## Product information

- for the highly accurate radial and axial alignment on alignment adaptors or machine spindles
- cooling lubricant without loss and flow-disruption thanks to the use of an intermediate tube
- balancing quality G6.3 / 15,000 rev./min
- for tool shank tolerance h6
- with axial damping screw for optimal concentricity

## Scope of delivery

- incl. adjustment screw with axial force
- damping Guh. no. 4941
- incl. 6 angular alignment sets Guhring no. 4715
- incl. 6 clamping screws
- order intermediate tube Guhring no. 4716 separately
- further dimensions on request

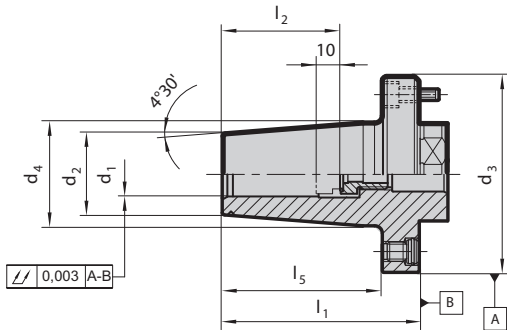

Module-Ø d <sub>3</sub> mm	for shank Ø d <sub>1</sub> h6 mm	d <sub>2</sub> mm	d <sub>4</sub> mm	l <sub>1</sub> mm	l <sub>2</sub> mm	l <sub>5</sub> mm	incl. setting screw Guh. no. 4941	intermediate sleeve tube Guhring no. 4716	Guhring no.	Discount group	Code no.	Availability
									4717	114		
60	6	21	27	70	36	56	6.100	14.010			6.060	●
60	8	21	27	70	36	56	8.100	14.010			8.060	●
60	10	24	32	70	40	56	10.100	14.020			10.060	●
60	12	24	32	70	45	56	12.100	14.030			12.060	●
70	12	24	32	75	45	60	12.100	14.020			12.070	●
70	14	27	34	75	45	60	14.100	14.020			14.070	●
70	16	27	34	75	48	60	16.100	14.040			16.070	●
80	18	33	42	80	48	65	18.100	14.050			18.080	●
80	20	33	42	80	50	65	20.100	14.040			20.080	●
100	25	44	52	80	56	61	25.100	20.010			25.100	●
100	32	44	52	80	60	61	32.100	20.020			32.100	●

## Module 6x6 HPC clamping chuck flange

### Product information

- for the highly accurate radial and axial alignment on alignment adaptors or machine spindles
- cooling lubricant without loss and flow-disruption thanks to the use of an intermediate tube
- highest concentricity, clamping force and rigidity thanks to mech. tension gearing
- suitable for internal cooling up to 80 bar
- positive damping characteristics
- for tool shank tolerance h6

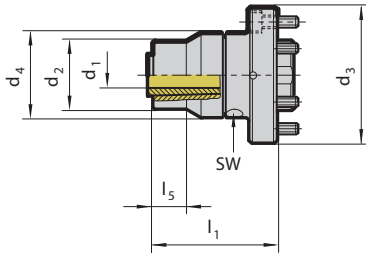

### Scope of delivery

- incl. hexagon chuck key Guhring no. 4912
- incl. 6 angular alignment sets Guhring no. 4715
- incl. 6 clamping screws
- order intermediate tube Guhring no. 4716 separately
- order clamping sleeves Guhring nos. 4302, 4235, 4236, 4237 separately



Guhring no.	4714
Discount group	114

Module-Ø d3 mm	for shank Ø d1 h6 mm	d2 mm	d4 mm	l1 mm	l5 mm	intermediate sleeve tube Guhring no. 4716	SW	Code no.	Availability
70	3 - 20	40	50	87	20	20.030	4	20.070	●
80	3 - 20	40	50	73	20	20.030	4	20.080	●
100	20 - 32	70	70	121	23	20.030	4	32.100	●

## Module 6x6 HSK adaptor flange

### Product information

- for the highly accurate radial and axial alignment on alignment adaptors or machine spindles
- suitable for MQL and conventional cooling
- for the transferable torsional moment the interface between spindle and flange has to be taken into consideration

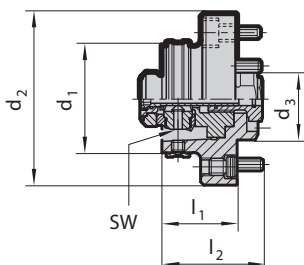

### Scope of delivery

- incl. MQL 4-point clamping set Guhring no. 4930
- clamping screw Guhring no. 4935
- incl. brass lock ring Guhring no. 4953
- incl. 6 angular alignment sets Guhring no. 4715
- incl. 6 clamping screws
- incl. intermediate tube



Guhring no.	4363
Discount group	114

HSK-C d1 mm	Module-Ø d2 mm	d3 mm	l1 mm	l2 mm	SW	Code no.	Availability
32	60	30	26	36	2.5	24.060	●
40	70	35	30	40	3.0	30.070	●
50	80	40	35	45	4.0	38.080	●
63	100	50	43	55	5.0	48.100	●
80	117	60	50	62	6.0	60.117	●
100	140	80	70	82	8.0	75.140	●

## Module 4x4 HSK-A alignment adaptor

### Product information

- for the highly accurate alignment of all modular flanges 4x4
- cooling lubricant without loss and flow-disruption thanks to the use of an intermediate tube
- suitable for MQL and conventional cooling
- balancing quality G6.3 / 15,000 rev./min
- 6 balancing threads M6

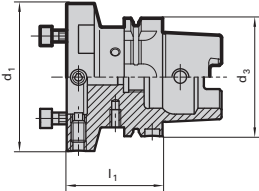

### Scope of delivery

- incl. 4 screws for radial adjustment
- incl. 4 clamping screws
- order coolant delivery set Guhring no. 4949, MQL coolant delivery set Guhring no. 4939 or 4940 separately
- order intermediate tube Guhring no. 4716 separately
- further dimensions on request



Guhring no. **4297**  
Discount group **114**

HSK-A	d <sub>3</sub> mm	d <sub>1</sub> mm	l <sub>1</sub> mm	Code no.	Availability
	63	60	60	60.063	●
	63	70	60	70.063	●
	63	80	60	80.063	●
	63	100	65	100.063	●
	63	117	65	117.063	●
	80	70	60	70.080	●
	80	80	60	80.080	●
	80	100	65	100.080	●
	80	117	65	117.080	●
	80	140	75	140.080	●
	100	70	55	70.100	●
	100	80	55	80.100	●
	100	100	65	100.100	●
	100	117	65	117.100	●
	100	140	75	140.100	●

## Module 4x4 ISO taper alignment adaptor

### Product information

- ISO taper to DIN 69871 form AD/B
- for the highly accurate alignment of all modular flanges 4x4
- cooling lubricant without loss and flow-disruption thanks to the use of an intermediate tube
- suitable for MQL and conventional cooling
- balancing quality G6.3 / 15,000 rev./min
- 6 balancing threads M6

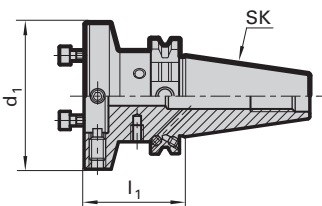

### Scope of delivery

- incl. 4 screws for radial adjustment
- incl. 4 clamping screws
- order intermediate tube Guhring no. 4716 separately
- order pull studs separately
- SK50/BT holder on request



Guhring no. **4724**  
Discount group **114**

ISO taper	d <sub>1</sub> mm	l <sub>1</sub> mm	Code no.	Availability
40	60	50	60.040	●
40	70	50	70.040	●
40	80	55	80.040	●
40	100	60	100.040	●

# Module 4x4 hydraulic chuck flange

## Product information

- for the highly accurate radial and axial alignment on alignment adaptors or machine spindles
- cooling lubricant without loss and flow-disruption thanks to the use of an intermediate tube
- balancing quality G6.3 / 15,000 rev./min
- for tool shank tolerance h6

## Scope of delivery

- incl. adjustment screw Guhring no. 4941 for conventional cooling
- incl. angular alignment set Guhring no. 4715
- incl. 4 clamping screws
- incl. hexagon chuck key Guhring no. 4912
- order intermediate tube Guhring no. 4716 separately
- for other clamping  $\varnothing$  apply reduction bushes Guhring no. 4368 or 4369
- MQL version on request

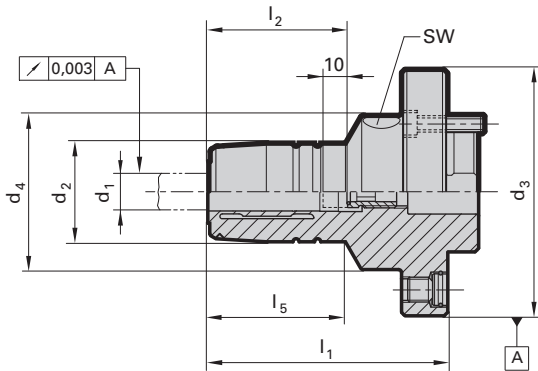

Guhring no. **4360**

Discount group **114**

Module- $\varnothing$ d <sub>3</sub> mm	for shank $\varnothing$ d <sub>1</sub> h6 mm	d <sub>2</sub> mm	d <sub>4</sub> mm	l <sub>1</sub> mm	l <sub>2</sub> mm	l <sub>5</sub> mm	incl. setting screw Guh. no. 4941	intermediate sleeve tube Guhring no. 4716	SW	Code no.	Availability
70	12	32	40	75.0	45	45.0	12.100	14.020	4	12.070	●
80	12	32	50	77.5	45	44.0	12.100	14.050	5	12.080	●
80	20	42	50	82.5	50	51.5	20.100	14.040	5	20.080	●
100	32	64	64	103.0	60	84.0	32.100	14.020	6	32.100	●

# Module 4x4 shrink fit chuck flange

## Product information

- for the highly accurate radial and axial alignment on alignment adaptors or machine spindles
- cooling lubricant without loss and flow-disruption thanks to the use of an intermediate tube
- balancing quality G6.3 / 15,000 rev./min
- for tool shank tolerance h6
- with axial damping screw for optimal concentricity

## Scope of delivery

- incl. adjustment screw with axial force
- damping Guh. no. 4941
- incl. angular alignment seten Guhring no. 4715
- incl. 4 clamping screws
- order intermediate tube Guhring no. 4716 separately
- further dimensions on request

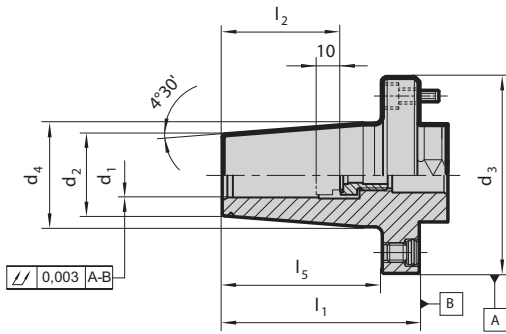

Module-Ø d <sub>3</sub> mm	for shank Ø d <sub>1</sub> h6 mm	d <sub>2</sub> mm	d <sub>4</sub> mm	l <sub>1</sub> mm	l <sub>2</sub> mm	l <sub>5</sub> mm	incl. setting screw Guh. no. 4941	intermediate sleeve tube Guhring no. 4716	Guhring no. 4760	
									Discount group 114	
									Code no.	Availability
60	6	21	27	70	36	56	6.100	14.010	6.060	●
60	8	21	27	70	36	56	8.100	14.010	8.060	●
60	10	24	32	70	40	56	10.100	14.020	10.060	●
60	12	24	32	70	45	56	12.100	14.030	12.060	●
70	12	24	32	75	45	60	12.100	14.020	12.070	●
70	14	27	34	75	45	60	14.100	14.020	14.070	●
70	16	27	34	75	48	60	16.100	14.040	16.070	●
80	18	33	42	80	48	65	18.100	14.050	18.080	●
80	20	33	42	80	50	65	20.100	14.040	20.080	●
100	25	44	52	80	56	61	25.100	20.010	25.100	●
100	32	44	52	80	60	61	32.100	20.020	32.100	●



## Module 4x4 HSK adaptor flange

### Product information

- for the highly accurate radial and axial alignment on alignment adaptors or machine spindles
- suitable for MQL and conventional cooling
- for the transferable torsional moment the interface between spindle and flange has to be taken into consideration

### Scope of delivery

- incl. MQL 4-point clamping set Guhring no. 4930
- incl. clamping screw Gohring no. 4935
- incl. brass lock ring Guhring no. 4953
- incl. 4 angular alignment sets Guhring no. 4715
- incl. 4 clamping screws
- incl. intermediate tube

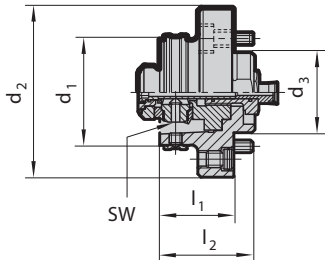

<b>Guhring no.</b>	<b>4713</b>
<b>Discount group</b>	<b>114</b>

HSK-C d1 mm	Module-Ø d2 mm	d3 mm	l1 mm	l2 mm	SW	Code no.	Availability
32	60	30	26	36	2.5	24.060	●
40	70	35	30	40	3.0	30.070	●
50	80	40	35	45	4.0	38.080	●
63	100	50	43	55	5.0	48.100	●
80	117	60	50	62	6.0	60.117	●
100	140	80	70	82	8.0	75.140	●

## Length adjustment screw for conventional cooling

### Product information

- To adapt MQL tool holders to meet the requirements of conventional wet machining. For plain end shanks. The height of screw head compensates the height of MQL taper

- for MQL HSK-A shrink fit and hydraulic chucks
- for use with shank according to DIN 6535 with plain shank end for conventional cooling
- with the patented face orientated O ring axial force damping is provided which prevents concentricity errors.

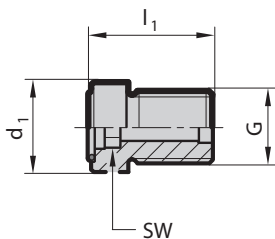

<b>Guhring no.</b>	<b>4941</b>
<b>Discount group</b>	<b>114</b>

for HSK-A	clamping- Ø	G	d1 mm	l1 mm	SW	Code no.	Availability
40	6	M5	6.0	15	2.5	6.041	●
40	6	M7x1	5.8	15	2.5	6.040	●
40	8	M7x1	5.8	18	3	8.040	●
50	6	M8x1	7.8	14	2.5	6.050	●
50	8	M8x1	6.8	18	3	8.050	●
40 / 50	10	M8x1	9.8	17.7	4	10.050	●
63/ 80/ 100	6	M10x1	5.8	17	2.5	6.100	●
63/ 80/ 100	8	M10x1	7.8	17	3	8.100	●
63/ 80/ 100	10	M10x1	9.8	16.2	4	10.100	●
40/ 50/ 63/ 80/ 100	12	M10x1	9.8	16.2	5	12.100	●
40/ 50/ 63/ 80/ 100	14	M10x1	9.8	17.2	5	14.100	●
50/ 63/ 80/ 100	16	M12x1	15.8	18.2	6	16.100	●
50/ 63/ 80/ 100	18	M12x1	15.8	19.2	6	18.100	●
50/ 63/ 80/ 100	20	M16x1	15.8	19.2	8	20.100	●
63/ 80/ 100	25	M16x1	15.8	22.7	8	25.100	●
63/ 80/ 100	32	M16x1	15.8	26.7	8	32.100	●

## Intermediate sleeves for module flange and alignment adapter 6x6 and 4x4

### Product information

- for sealing when machining with either coolant or MQL

### Scope of delivery

- with O-ring and sealing lip

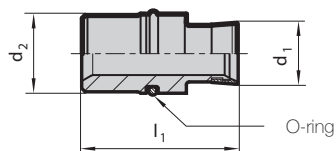

<b>Guhring no.</b>	<b>4716</b>
<b>Discount group</b>	<b>114</b>

d <sub>1</sub> mm	d <sub>2</sub> mm	l <sub>1</sub> mm	O-ring	Code no.	Availability
10.7	14	47.5	10x1.5	14.010	●
10.7	14	32.0	10x1.5	14.020	●
10.7	14	37.5	10x1.5	14.030	●
10.7	14	27.4	10x1.5	14.040	●
10.7	14	32.4	10x1.5	14.050	●
10.7	20	28.0	17x1.5	20.010	●
10.7	20	25.5	17x1.5	20.020	●
10.7	20	16.5	17x1.5	20.030	●

## Angle alignment units for module flange and alignment adapter 6x6 and 4x4

### Product information

- consisting of pressure disc and threaded pin for accurate angle alignment of module flanges

### Scope of delivery

- pressure disc, threaded pin and snap ring

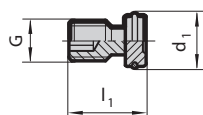

<b>Guhring no.</b>	<b>4715</b>
<b>Discount group</b>	<b>114</b>

for module	G	d <sub>1</sub> mm	l <sub>1</sub> mm	Code no.	Availability
60 / 70 / 80	M8x1	11.5	13	8.010	●
100 / 117 / 140	M10x1	13.6	19	10.010	●

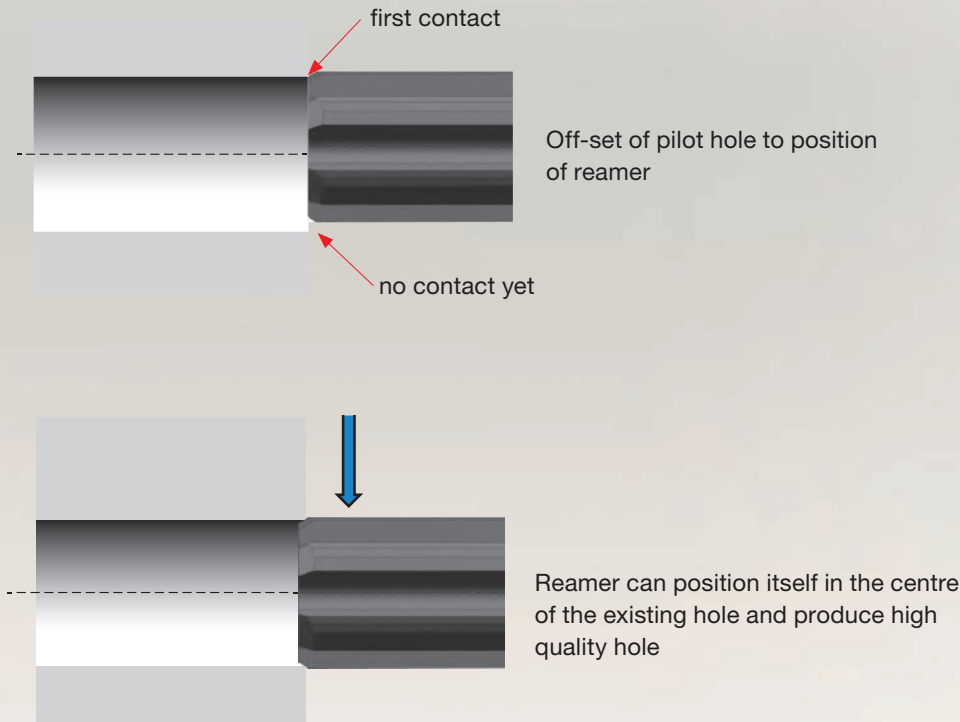
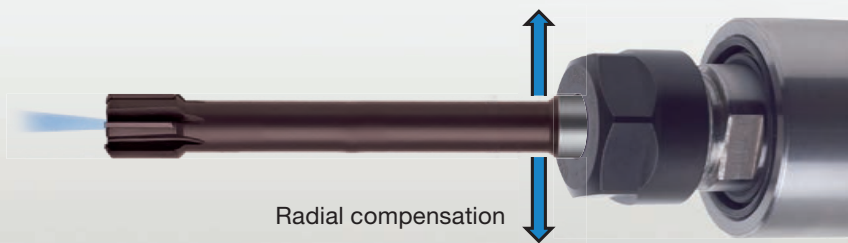

## Floating holder for perfect HPC reaming

For the fine machining of holes the matching of pilot hole with the tool axis is a pre-requisite for the perfect functioning of the reamer. Floating holders serve to compensate the lateral off-set between tool and pilot hole. This off-set is usually created by machining with multiple clamping operations, cycle and positioning errors during tool and workpiece changes as well as by alignment errors on turning machines. As our floating holders have been designed for high-speed reaming operations, we consciously dispense of angle compensation. This improves the clamping rigidity. When the radial play is excessive upon entry into the pilot hole the reamer is subjected to high stresses. Crumbling of the edges is the consequence. Limited radial play on our floating holders compensates for any possible vibration even at high speeds.

Coolant ducts integrated in the floating holder ensure the reamer is optimally supplied with cooling lubricant. Longer hole tolerance compliancy and tool life are the result. Higher economic efficiency thanks to cost and time saving is guaranteed.

**When a high precision hole position is required, we recommend a pilot with 1 - or 2-flute fineboring tools see chapter „pilot tools“.**

## Floating holders with side lock holder

### Product information

- straight shank d<sub>3</sub> with whistle notch flat
- suitable for conventional and high performance multi-fluted reamers, because of no angle compensation
- central coolant supply max. 80 bar
- drive flat on tool shank necessary
- for tool shank tolerance h6

### Scope of delivery

- for other shank Ø order reduction sleeves Guhring no. 4095 separately
- order hexagon chuck key Guhring no. 4912 separately
- further sizes with differing radial play are available on request

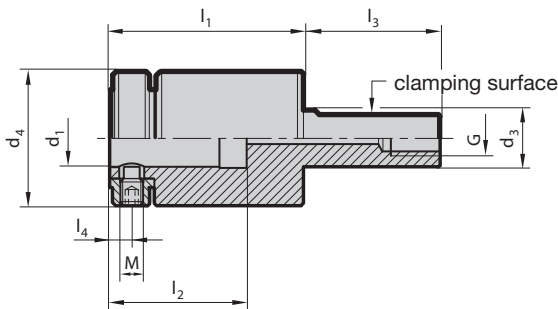

<b>Guhring no.</b>	<b>4167</b>
<b>Discount group</b>	<b>Net price</b>
<b>Code no.</b>	<b>Availability</b>
20.020	●
25.025	●
32.032	●

d <sub>3</sub> g6 mm	for holder d <sub>1</sub> h6 mm	recommen- ded tool-Ø	d <sub>4</sub> mm	l <sub>1</sub> mm	l <sub>2</sub> mm	l <sub>3</sub> mm	l <sub>4</sub> mm	G	M	radial play
20	20	up to Ø 28	49	75	50	50	9.5	1/8	M8	0.12
25	25	Ø 10 - Ø 36	59	85	60	60	9.5	1/4	M10	0.12
32	32	Ø 16 - Ø 60	80	92	63	80	12.5	3/8	M12	0.12

## Short floating holders with side lock holder

### Product information

- straight shank d<sub>3</sub> with whistle notch flat
- suitable for conventional and high performance multi-fluted reamers, because of no angle compensation
- central coolant supply max. 80 bar
- drive flat on tool shank necessary
- for tool shank tolerance h6

### Scope of delivery

- for other shank Ø order reduction sleeves Guhring no. 4095 separately
- order hexagon chuck key Guhring no. 4912 separately
- further sizes with differing radial play are available on request

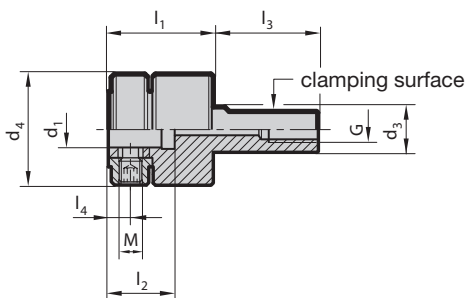

<b>Guhring no.</b>	<b>4169</b>
<b>Discount group</b>	<b>Net price</b>
<b>Code no.</b>	<b>Availability</b>
10.020	●
16.020	●
20.020	●

d <sub>3</sub> g6 mm	for holder d <sub>1</sub> h6 mm	recommen- ded tool-Ø	d <sub>4</sub> mm	l <sub>1</sub> mm	l <sub>2</sub> mm	l <sub>3</sub> mm	l <sub>4</sub> mm	G	M	radial play
20	10	up to Ø 14	38.5	46	25	40	6	1/8	M6	0.08
20	16	up to Ø 22	49	46	29	46	7	1/8	M6	0.10
20	20	up to Ø 28	49	46	29	46	7	1/8	M6	0.12

## Mini floating holders with side lock holder

### Product information

- holder shank with lateral clamping surface
- suitable for conventional and high performance multi-fluted reamers, because of no angle compensation
- very compact design for restricted space
- central coolant supply max. 80 bar
- drive flat on tool shank necessary
- for tool shank tolerance h6

### Scope of delivery

- for other shank  $\varnothing$  order reduction sleeves Guhring no. 4097 separately
- order hexagon chuck key Guhring no. 4912 separately
- further sizes with differing radial play are available on request

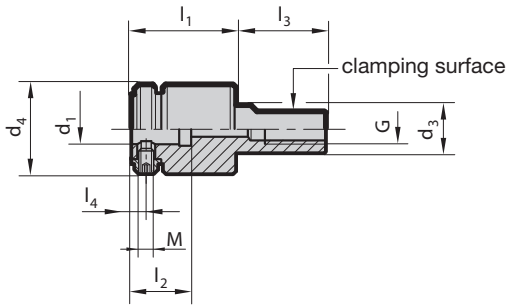

Guhring no. **4174**

Discount group **Net price**

d <sub>3</sub> g6 mm	for holder d <sub>1</sub> h6 mm	recommen- ded tool- $\varnothing$	d <sub>4</sub> mm	l <sub>1</sub> mm	l <sub>2</sub> mm	l <sub>3</sub> mm	l <sub>4</sub> mm	G	M	radial play	Code no.	Availability
16	10	to $\varnothing$ 14	30	35	20	30	5	1/8	M5	0.12	10.016	●

## Floating holder with ER collet holder

### Product information

- straight shank d<sub>3</sub> with whistle notch flat
- suitable for conventional and high performance multi-fluted reamers, because of no angle compensation
- for the application of internally cooled reamers use metallic sealed collets type DM Guhring no. 4175
- central coolant supply max. 80 bar

### Scope of delivery

- incl. retaining nut
- order collet Guhring no. 4175 or 4307 as well as clamping key Guhring no. 4913 separately
- further sizes with differing radial play are available on request

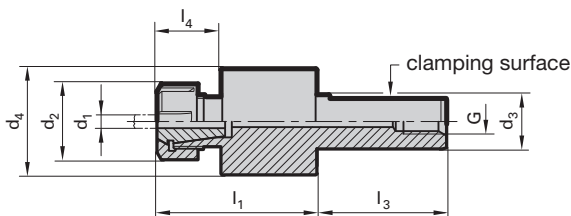

Guhring no. **4098**

Discount group **Net price**

d <sub>3</sub> g6 mm	recommended tool- $\varnothing$ d1 mm	clamping range	d <sub>2</sub> mm	d <sub>4</sub> mm	l <sub>1</sub> mm	l <sub>3</sub> mm	l <sub>4</sub> mm	G	radial play	Code no.	Availability
16	up to $\varnothing$ 16	ER20 $\varnothing$ 1-13	34	49.5	74	40	29.5	1/8	0.06	20.016	●
20	$\varnothing$ 4- $\varnothing$ 24	ER25 $\varnothing$ 2-16	42	59	84	50	35	1/8	0.06	25.020	●
25	up to $\varnothing$ 16	ER20 $\varnothing$ 1-13	34	49.5	74	60	29.5	1/4	0.08	20.025	●
25	$\varnothing$ 4- $\varnothing$ 24	ER25 $\varnothing$ 2-16	42	59	84	60	35	1/4	0.08	25.025	●
32	$\varnothing$ 6 - $\varnothing$ 30	ER32 $\varnothing$ 3-20	50	64	91	80	35.5	3/8	0.10	32.032	●
40	$\varnothing$ 6 - $\varnothing$ 30	ER32 $\varnothing$ 3-20	50	64	91	80	35.5	1/2	0.12	32.040	●

## Floating side lock holder VDI DIN 69880-1

### Product information

- VDI holder shank with teeth
- suitable for conventional and high performance multi-fluted reamers, because of no angle compensation
- central coolant supply max. 80 bar
- tool shank with special whistle notch flat necessary
- drive flat on tool shank necessary
- for tool shank tolerance h6

### Scope of delivery

- for other shank  $\varnothing$  order reduction sleeves Guhring no. 4095 separately
- order hexagon chuck key Guhring no. 4912 separately
- further dimensions available on request

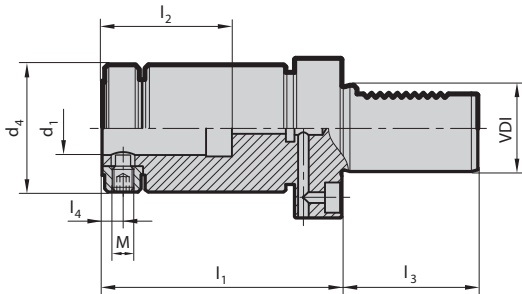

Guhring no.

4117

Discount group

Net price

VDI	holder d <sub>1</sub> h6 mm	clamping range	d <sub>4</sub> mm	l <sub>1</sub> mm	l <sub>2</sub> mm	l <sub>3</sub> mm	l <sub>4</sub> mm	M	radial play	Code no.	Availability
30	25	Ø 16-25	59	111	59	55	9.5	M10	0.12	25.030	●
40	25	Ø 16-25	59	111	59	63	9.5	M10	0.12	25.040	●
40	32	Ø 20-32	80	117	63	63	12.5	M12	0.12	32.040	●
50	25	Ø 16-25	59	111	59	78	9.5	M10	0.12	25.050	●
50	32	Ø 20-32	80	117	63	78	12.5	M12	0.12	32.050	●

## Floating ER Collet holder VDI DIN 69880-1

### Product information

- VDI holder shank with teeth
- suitable for conventional and high performance multi-fluted reamers, because of no angle compensation
- for the application of internally cooled reamers use metallic sealed collets type DM Guhring no. 4175
- with coolant supply max. 80 bar

### Scope of delivery

- incl. retaining nut
- order collet Guhring no. 4175 or 4307 as well as clamping key Guhring no. 4913 separately
- further sizes with differing radial play are available on request

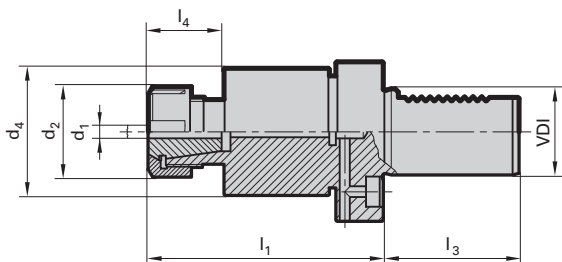

Guhring no.

4116

Discount group

Net price

VDI	recommended tool-Ø	clamping range	d <sub>2</sub> mm	d <sub>4</sub> mm	l <sub>1</sub> mm	l <sub>3</sub> mm	l <sub>4</sub> mm	radial play	Code no.	Availability
30	up to Ø 20	ER25 Ø 2-16	42	59	109	55	35	0.08	25.030	●
40	up to Ø 20	ER25 Ø 2-16	42	59	109	63	35	0.10	25.040	●
40	Ø 6- Ø 32	ER32 Ø 3-20	50	64	116	63	35.5	0.10	32.040	●
50	up to Ø 20	ER25 Ø 2-16	42	59	109	78	35	0.12	25.050	●
50	Ø 6- Ø 32	ER32 Ø 3-20	50	64	116	78	35.5	0.12	32.050	●

## Reduction sleeves for floating holder

### Product information

- for reducing the clamping diameter in floating holders
- central coolant supply
- drive flat on tool shank necessary
- applicable in floating holders Guhring no. 4167 and 4117

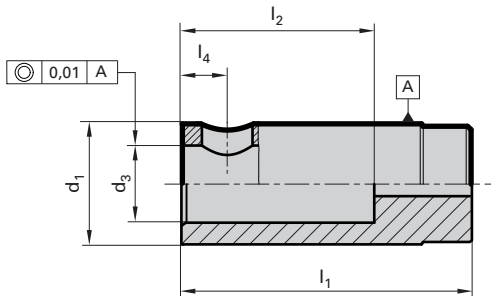

Guhring no.	4095
Discount group	Net price

d1 mm	for shank Ø d3 h6 mm	l1 mm	l2 mm	l4 mm	Code no.	Availability
20	14	50	40	9.5	14.020	●
20	16	50	40	9.5	16.020	●
25	16	60	40	9.5	16.025	●
25	18	60	40	9.5	18.025	●
25	20	60	50	9.5	20.025	●
32	20	63	50	12.5	20.032	●
32	25	63	60	12.5	25.032	●

## Reduction sleeves for short floating holder

### Product information

- for reducing the clamping diameter in floating holders
- central coolant supply
- drive flat on tool shank necessary
- applicable in short floating holders Guhring no. 4169

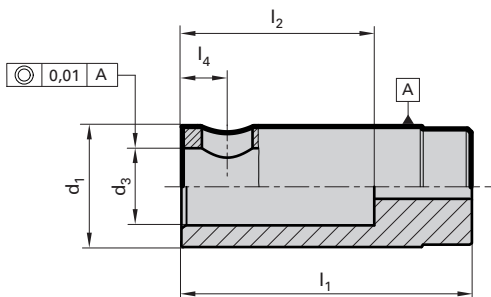

Guhring no.	4096
Discount group	Net price

d1 mm	for shank Ø d3 h6 mm	l1 mm	l2 mm	l4 mm	Code no.	Availability
10	4	25	10	6.0	4.010	●
10	6	25	-	6.0	6.010	●
10	8	25	20	6.0	8.010	●
16	10	29	25	7.0	10.016	●
16	12	29	25	7.0	12.016	●
20	12	29	25	7.0	12.020	●
20	14	29	25	7.0	14.020	●
20	16	29	25	7.0	16.020	●

## Reduction sleeves for mini floating holder

### Product information

- for reducing the clamping diameter in floating holders
- central coolant supply
- drive flat on tool shank necessary
- applicable in mini floating holders Guhring no. 4174

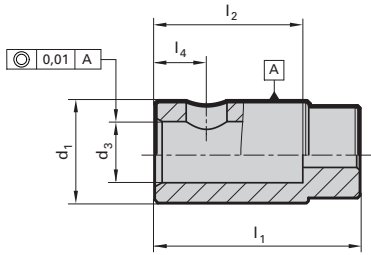

Guhring no.	4097
Discount group	Net price

d1 mm	d3 mm	l1 mm	l2 mm	l4 mm	Code no.	Availability
10	4	20	15	5	4.010	●
10	6	20	15	5	6.010	●
10	8	20	15	5	8.010	●

## Collets ER metallic sealed

### Product information

- DIN ISO 15488
- for application without sealing washer
- concentricity error max. 6 µm
- for high-performance tools with internal cooling e.g. HR 500 reamers
- ER-DM collets with restricted clamping range

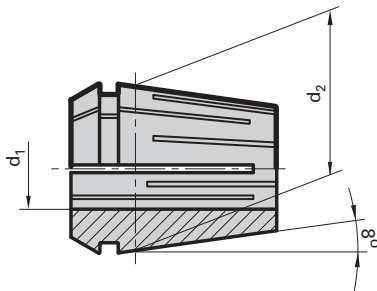

Guhring no.	4175
Discount group	114











nom. size d2	clamping range d1 h9	Code no.	Availability
ER20	3.00	3.020	●
ER20	4.00	4.020	●
ER20	5.00	5.020	●
ER20	6.00	6.020	●
ER20	7.00 - 6.50	7.020	●
ER20	8.00 - 7.50	8.020	●
ER20	9.00 - 8.50	9.020	●
ER20	10.00 - 9.50	10.020	●
ER20	11.00 - 10.50	11.020	●
ER20	12.00 - 11.50	12.020	●
ER20	13.00 - 12.50	13.020	●
ER25	6.00	6.025	●
ER25	8.00 - 7.50	8.025	●
ER25	10.00 - 9.50	10.025	●
ER25	12.00 - 11.50	12.025	●
ER25	14.00 - 13.50	14.025	●
ER25	16.00 - 15.50	16.025	●
ER32	6.00	6.032	●
ER32	8.00 - 7.50	8.032	●
ER32	10.00 - 9.50	10.032	●
ER32	12.00 - 11.50	12.032	●
ER32	14.00 - 13.50	14.032	●
ER32	16.00 - 15.50	16.032	●
ER32	18.00 - 17.50	18.032	●
ER32	20.00 - 19.50	20.032	●





# COUNTERSINKING & DE-BURRING

# HSS, HSS-E and carbide countersinks

Standard	Form	Tool illustration	Tool material	Surface finish	d1	Guhring no.	Discount group	Standard range page
<b>60° countersinks</b>								
DIN 334	C		HSS	○	6.300 - 25.000	472	105	134
DIN 334	A		HSS	○ $\begin{matrix} >0 \\ 8,00 \end{matrix}$	8.000 - 20.000	470	105	135
DIN 334	D		HSS	●	16.000 - 80.000	473	105	136
DIN 334	B		HSS	●	16.000 - 100.000	471	105	137
<b>90° countersinks</b>								
DIN 335	A		HSS	○ $\begin{matrix} >0 \\ 8,00 \end{matrix}$	8.000 - 20.000	474	105	138
DIN 335	C		HSS	○	4.300 - 31.000	476	105	139
DIN 335	C		HSS	● A	4.300 - 31.000	1326	105	139
DIN 335	C		HSS	● S	5.000 - 31.000	327	105	139
DIN 335	D		HSS	○	15.000 - 100.000	477	105	140
DIN 335	D		HSS	● S	25.000 - 50.000	328	105	140
DIN 335	B		HSS	●	16.000 - 100.000	475	105	141
<b>90° countersinks set</b>								
DIN 335	C		HSS	○	7.000 - 7.000	498	105	142
DIN 335	C		HSS	● S	7.000 - 7.000	499	105	142

○ bright    ● steam tempered    ● nitrided    ● A TiAlN    ● a TiAlN nanoA    ● Cb Carbo    ● S TiN

Standard	Form	Tool illustration	Tool material	Surface finish	d1	Guhring no.	Discount group	Standard range page
----------	------	-------------------	---------------	----------------	----	-------------	----------------	---------------------

## 90° countersinks for fine tolerances

DIN 1866		HSS	○	2.000 - 19.000	436	105	143
----------	---	-----	---	----------------	-----	-----	-----





## 90° countersinks for medial tolerances

DIN 1866		HSS	○	6.600 - 21.500	437	105	144
----------	---	-----	---	----------------	-----	-----	-----



## 90° countersinks for tapping size holes

DIN 1866		HSS	○	6.000 - 19.000	438	105	145
----------	---	-----	---	----------------	-----	-----	-----

## 120° countersinks

DIN 347	A 	HSS	○ <sub>8,00</sub> <sup>&gt;0</sup>	8.000 - 20.000	478	105	146
G	C 	HSS	○	16.000 - 16.000	480	105	147
G	D 	HSS	●	25.000 - 40.000	481	105	148
DIN 347	B 	HSS	●	25.000 - 100.000	479	105	149

## Counterbores with fixed pilots for fine tolerances



DIN 373		HSS	○	2.200 - 20.000	482	105	150
DIN 373		HSS	Ⓢ	8.000 - 20.000	324	105	150
G		HSS	●	18.000 - 40.000	485	105	151

HSS, HSS-E and carbide countersinks



# HSS, HSS-E and carbide countersinks

Standard	Form	Tool illustration	Tool material	Surface finish	d1	Guhring no.	Discount group	Standard range page
----------	------	-------------------	---------------	----------------	----	-------------	----------------	---------------------

## Counterbores with fixed pilots for medial tolerances

DIN 373		HSS	○	6.000 - 20.000	483	105	152
DIN 373		HSS	Ⓢ	6.000 - 18.000	325	105	152
G		HSS	●	18.000 - 40.000	486	105	153

## Counterbores with fixed pilots for tapping size holes

DIN 373		HSS	○	6.000 - 20.000	484	105	154
DIN 373		HSS	Ⓢ	6.000 - 18.000	326	105	154
G		HSS	●	20.000 - 26.000	487	105	155

## Counterbores with hole for detachable pilot

DIN 375		HSS	●	15.000 - 63.000	463	105	156
---------	---	-----	---	-----------------	-----	-----	-----

## Detachable pilot for fine tolerances

DIN 1868		HSS	○	8.400 - 25.000	464	105	157
----------	---	-----	---	----------------	-----	-----	-----

## Detachable pilot for medial tolerances

DIN 1868		HSS	○	9.000 - 39.000	465	105	158
----------	---	-----	---	----------------	-----	-----	-----





## Detachable pilot for tapping size holes

DIN 1868		HSS	○	6.800 - 32.000	466	105	159
----------	---	-----	---	----------------	-----	-----	-----

○ bright    ● steam tempered    ● nitrided    **A** TiAlN    **a** TiAlN nanoA    **Cb** Carbo    **S** TiN

Standard	Form	Tool illustration	Tool material	Surface finish	d1	Guhring no.	Discount group	Standard range page
----------	------	-------------------	---------------	----------------	----	-------------	----------------	---------------------

## Spot facers

DIN 1862		HSS-E	●	3.500 - 13.000	432	105	160
DIN 1862		HSS-E	●	6.000 - 30.000	433	105	161
DIN 1862		HSS-E	●	10.000 - 30.000	434	105	162
DIN 1862		HSS-E	●	20.000 - 48.000	435	105	163

## De-burring tools

Standard	Form	Tool illustration	Tool material	Surface finish	d1	Guhring no.	Discount group	Standard range page
----------	------	-------------------	---------------	----------------	----	-------------	----------------	---------------------

### De-burring forks

G		Solid carbide	○	2.000 - 8.000	4101	Net price	165
G		Solid carbide	○	2.000 - 8.000	4100	Net price	166

### Front/back deburrer 90°

G		Solid carbide	a	3.000 - 12.000	495	120	168
---	---	---------------	---	----------------	-----	-----	-----

HSS, HSS-E and carbide countersinks

○ bright

● steam tempered

● nitrided

● TiAlN

● TiAlN nanoA

● Carbo

● TiN

# 60° countersinks

HSS

DIN  
334

Cyl

three-fluted  
radial relief ground

C

<b>Guhring no.</b>	<b>472</b>
<b>P (N/mm<sup>2</sup>)</b>	<b>1000</b>
<b>M</b>	○
<b>K</b>	●
<b>N</b>	●
<b>S</b>	○
<b>H (HRC)</b>	
<b>Surface finish</b>	○
<b>Discount group</b>	<b>105</b>

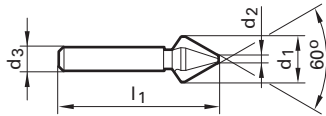

Code no.	d1	d3	l1	d2		Unit price in €
	mm	mm	mm	mm		
6.300	6.300	5.000	45.00	1.600	3	12.50
8.000	8.000	6.000	50.00	2.000	3	11.20
12.500	12.500	8.000	56.00	3.200	3	14.70
16.000	16.000	10.000	63.00	4.000	3	17.80
20.000	20.000	10.000	67.00	5.000	3	24.50
25.000	25.000	10.000	71.00	6.300	3	35.00

HSS, HSS-E and  
carbide countersinks

- bright
- steam tempered
- nitrided
- TiAlN
- TiAlN nanoA
- Carbo
- TiN

# 60° countersinks

HSS

DIN 334

Cyl

Multi-fluted  
straight-fluted  
and relief-ground

<b>A</b>	
<b>Guhring no.</b>	<b>470</b>
<b>P (N/mm²)</b>	<b>1400</b>
<b>M</b>	○
<b>K</b>	●
<b>N</b>	●
<b>S</b>	○
<b>H (HRC)</b>	
<b>Surface finish</b>	
<b>Discount group</b>	<b>105</b>

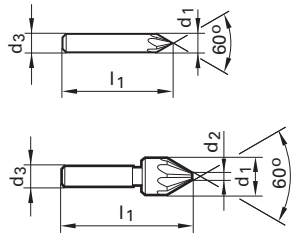

Code no.	d1	d3	l1	d2	
	mm	mm	mm	mm	
8.000	8.000	8.000	50.00		5
12.500	12.500	8.000	50.00	2.000	5
16.000	16.000	10.000	60.00	3.200	7
20.000	20.000	10.000	63.00	5.000	7

Unit price in €
13.00
25.50
29.50
40.50

HSS, HSS-E and carbide countersinks

- bright
- steam tempered
- nitrided
- TiAlN
- TiAlN nanoA
- Carbo
- TiN

# 60° countersinks

**HSS**

DIN  
334



three-fluted  
radial relief ground

**D**

<b>Guhring no.</b>	<b>473</b>
<b>P (N/mm²)</b>	<b>1000</b>
<b>M</b>	○
<b>K</b>	●
<b>N</b>	●
<b>S</b>	○
<b>H (HRC)</b>	
<b>Surface finish</b>	●
<b>Discount group</b>	<b>105</b>

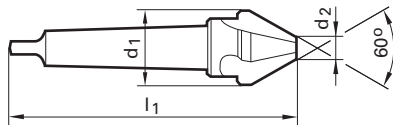

Code no.	d1	MK	l1	d2	
	mm			mm	
16.000	16.000	1	90.00	4.000	3
20.000	20.000	2	106.00	5.000	3
25.000	25.000	2	112.00	6.300	3
31.500	31.500	2	118.00	10.000	3
40.000	40.000	3	150.00	12.500	3
50.000	50.000	3	160.00	16.000	3
63.000	63.000	4	190.00	20.000	3
80.000	80.000	4	200.00	25.000	3

Unit price in €
43.00
54.00
49.50
58.00
92.00
120.00
240.00
430.00

HSS, HSS-E and  
carbide countersinks

- bright
- steam tempered
- nitrided
- TiAlN
- TiAlN nanoA
- Carbo
- TiN



# 60° countersinks

HSS

DIN  
334



Multi-fluted  
straight-fluted  
and relief-ground  
Ø 100.00 mm to Guhring standard

B

Guhring no.	471
P (N/mm <sup>2</sup> )	1400
M	○
K	●
N	●
S	○
H (HRC)	
Surface finish	●
Discount group	105

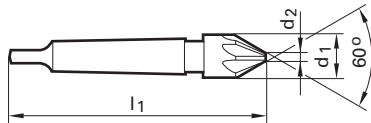

Code no.	d1	MK	l1	d2	
	mm				
16.000	16.000	1	100.00	3.200	7
25.000	25.000	2	125.00	7.000	9
31.500	31.500	2	132.00	9.000	9
40.000	40.000	3	160.00	12.000	11
50.000	50.000	3	170.00	16.000	13
100.000	100.000	4	224.00	31.500	17

Unit price in €
74.00
93.00
125.00
170.00
306.00
1400.00

HSS, HSS-E and carbide countersinks

- bright
- steam tempered
- nitrided
- TiAlN
- TiAlN nanoA
- Carbo
- TiN

# 90° countersinks

HSS

DIN 335

Cyl

Multi-fluted  
straight-fluted  
and relief-ground

A

Guhring no. 474

P (N/mm<sup>2</sup>) 1400

M ○

K ●

N ●

S ○

H (HRC)

Surface finish  >0.8,00

Discount group 105

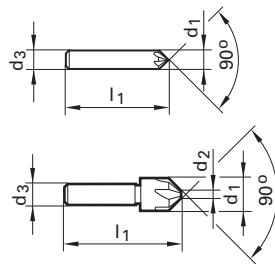

Code no.	d1	d3	l1	d2	
	mm	mm	mm	mm	
8.000	8.000	8.000	48.00		5
12.500	12.500	8.000	48.00	2.000	5
16.000	16.000	10.000	56.00	3.200	7
20.000	20.000	10.000	60.00	5.000	7

Unit price in €
13.70
23.00
34.00
39.50

HSS, HSS-E and carbide countersinks

- bright
- steam tempered
- nitrided
- TiAlN
- TiAlN nanoA
- Carbo
- TiN

# 90° countersinks

HSS

DIN 335

Cyl

three-fluted  
radial relief ground

	C	C	C
<b>Guhring no.</b>	476	1326	327
<b>P (N/mm<sup>2</sup>)</b>	1000	1000	1000
<b>M</b>	○	○	○
<b>K</b>	●	●	●
<b>N</b>	●	○	○
<b>S</b>	○	○	○
<b>H (HRC)</b>			
<b>Surface finish</b>	○	ⓐ	Ⓢ
<b>Discount group</b>	105	105	105
	Ⓡ	Ⓡ	Ⓡ

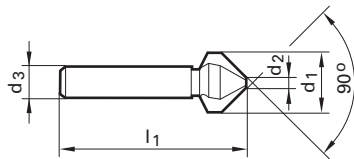

Code no.	d1	d3	l1	d2	
	mm	mm	mm	mm	
4.300	4.300	4.000	40.00	1.300	3
5.000	5.000	4.000	40.00	1.500	3
5.300	5.300	4.000	40.00	1.500	3
5.800	5.800	5.000	45.00	1.500	3
6.000	6.000	5.000	45.00	1.500	3
6.300	6.300	5.000	45.00	1.500	3
7.000	7.000	6.000	50.00	1.800	3
7.300	7.300	6.000	50.00	1.800	3
8.000	8.000	6.000	50.00	2.000	3
8.300	8.300	6.000	50.00	2.000	3
9.400	9.400	6.000	50.00	2.200	3
10.000	10.000	6.000	50.00	2.500	3
10.400	10.400	6.000	50.00	2.500	3
11.500	11.500	8.000	56.00	2.800	3
12.400	12.400	8.000	56.00	2.800	3
13.400	13.400	8.000	56.00	2.900	3
15.000	15.000	10.000	60.00	3.200	3
16.500	16.500	10.000	60.00	3.200	3
19.000	19.000	10.000	63.00	3.500	3
20.500	20.500	10.000	63.00	3.500	3
23.000	23.000	10.000	67.00	3.800	3
25.000	25.000	10.000	67.00	3.800	3
26.000	26.000	10.000	67.00	3.800	3
28.000	28.000	12.000	71.00	4.000	3
30.000	30.000	12.000	71.00	4.200	3
31.000	31.000	12.000	71.00	4.200	3

Unit price in €		
10.90	29.00	
9.90	30.50	22.50
11.40		
14.00	30.50	
10.00	29.00	
11.00	29.00	22.50
10.60	33.00	
11.10	32.50	25.50
12.40	32.50	25.50
13.70		45.00
13.40	33.00	28.00
14.30	35.50	31.00
14.30	43.50	33.50
15.10	36.50	33.00
16.20	57.00	40.00
16.90	44.00	38.00
17.80	44.00	39.50
24.00	64.00	
24.50	62.00	56.00
31.50	90.00	
34.50	83.00	76.00
45.50	139.00	
46.50	131.00	
51.00	142.00	93.00
51.00	135.00	98.00

HSS, HSS-E and carbide countersinks

○ bright    ● steam tempered    ● nitrided    ⓐ TiAlN    Ⓜ TiAlN nanoA    Ⓒb Carbo    Ⓢ TiN

# 90° countersinks

# HSS

DIN  
335



three-fluted  
radial relief ground  
Ø 100.00 mm to Guhring standard

	D	D
<b>Guhring no.</b>	<b>477</b>	<b>328</b>
<b>P (N/mm²)</b>	<b>1000</b>	<b>1000</b>
<b>M</b>	○	○
<b>K</b>	●	●
<b>N</b>	●	○
<b>S</b>	○	○
<b>H (HRC)</b>		
<b>Surface finish</b>	○	Ⓢ
<b>Discount group</b>	105	105

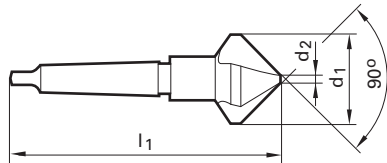

Code no.	d1	MK	l1	d2	
	mm			mm	
15.000	15.000	1	85.00	3.200	3
16.500	16.500	1	85.00	3.200	3
19.000	19.000	2	100.00	3.500	3
20.500	20.500	2	100.00	3.500	3
23.000	23.000	2	106.00	3.800	3
25.000	25.000	2	106.00	3.800	3
26.000	26.000	2	106.00	3.800	3
28.000	28.000	2	112.00	4.000	3
30.000	30.000	2	112.00	4.200	3
31.000	31.000	2	112.00	4.200	3
34.000	34.000	2	118.00	4.500	3
37.000	37.000	2	118.00	4.800	3
40.000	40.000	3	140.00	10.000	3
50.000	50.000	3	150.00	14.000	3
63.000	63.000	4	180.00	16.000	3
80.000	80.000	4	190.00	22.000	3
100.000	100.000	4	200.00	28.000	3

Unit price in €	
43.00	
45.50	
68.00	
59.00	
59.00	
56.00	115.00
70.00	
61.00	
60.00	
62.00	126.00
66.00	
72.00	144.00
90.00	187.00
112.00	230.00
182.00	
314.00	
440.00	

HSS, HSS-E and  
carbide countersinks

- bright
- steam tempered
- nitrided
- ⓐ TiAlN
- ⓐ TiAlN nanoA
- Ⓒb Carbo
- Ⓢ TiN

# 90° countersinks

HSS

DIN  
335



Multi-fluted  
straight-fluted  
and relief-ground  
Ø 100.00 mm to Guhring standard

B

<b>Guhring no.</b>	<b>475</b>
<b>P (N/mm²)</b>	<b>1400</b>
<b>M</b>	○
<b>K</b>	●
<b>N</b>	●
<b>S</b>	○
<b>H (HRC)</b>	
<b>Surface finish</b>	●
<b>Discount group</b>	<b>105</b>

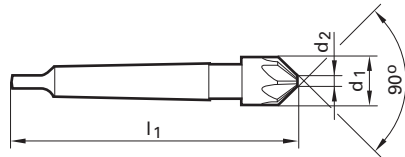

Code no.	d1	MK	l1	d2	
	mm			mm	
16.000	16.000	1	95.00	3.200	7
20.000	20.000	2	106.00	5.000	7
25.000	25.000	2	118.00	7.000	9
31.500	31.500	2	122.00	9.000	9
40.000	40.000	3	150.00	12.000	11
50.000	50.000	3	155.00	16.000	13
63.000	63.000	4	185.00	20.000	15
80.000	80.000	4	196.00	25.000	17
100.000	100.000	4	212.00	31.500	17

Unit price in €
56.00
78.00
85.00
101.00
158.00
220.00
358.00
650.00
1800.00

HSS, HSS-E and  
carbide countersinks

- bright
- steam tempered
- nitrided
- TiAlN
- TiAlN nanoA
- Carbo
- TiN



# 90° countersinks for fine tolerances

HSS

DIN  
1866

Cyl

right hand spiral flutes  
with fixed pilot  
Ø 19.00 mm to Guhring standard

<b>Guhring no.</b>	<b>436</b>
<b>P (N/mm<sup>2</sup>)</b>	<b>1000</b>
<b>M</b>	○
<b>K</b>	●
<b>N</b>	●
<b>S</b>	○
<b>H (HRC)</b>	
<b>Surface finish</b>	○
<b>Discount group</b>	<b>105</b>

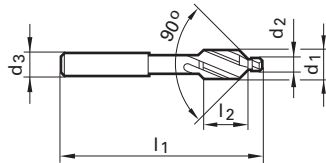

Code no.	d1	d2	d3	l1	l2	thread	
	mm	mm	mm	mm	mm		
2.000	2.000	1.100	2.000	45.00	7.00	M 1	2
2.500	2.500	1.300	2.500	45.00	7.00	M 1,2	2
2.800	2.800	1.500	2.800	45.00	7.00	M 1,4	2
3.300	3.300	1.700	3.300	56.00	10.00	M 1,6	2
3.800	3.800	2.000	3.800	56.00	10.00	M 1,8	2
4.300	4.300	2.200	4.300	56.00	10.00	M 2	2
5.000	5.000	2.700	5.000	56.00	10.00	M 2,5	2
6.000	6.000	3.200	5.000	71.00	14.00	M 3	3
8.000	8.000	4.300	5.000	71.00	14.00	M 4	3
10.000	10.000	5.300	8.000	80.00	18.00	M 5	3
11.500	11.500	6.400	8.000	80.00	18.00	M 6	3
15.000	15.000	8.400	12.500	100.00	22.00	M 8	3
19.000	19.000	10.500	12.500	100.00	22.00	M10	3

Unit price in €
34.00
34.00
34.00
34.00
34.00
<b>39.50</b>
<b>36.00</b>
<b>34.00</b>
<b>35.50</b>
<b>38.50</b>
<b>46.00</b>
<b>60.00</b>
96.00

HSS, HSS-E and carbide countersinks

- bright
- steam tempered
- nitrided
- TiAIN
- TiAIN nanoA
- Carbo
- TiN



right hand spiral flutes  
with fixed pilot  
Ø 21.50 mm to Guhring standard

<b>Guhring no.</b>	<b>437</b>
<b>P (N/mm²)</b>	<b>1000</b>
<b>M</b>	○
<b>K</b>	●
<b>N</b>	●
<b>S</b>	○
<b>H (HRC)</b>	
<b>Surface finish</b>	○
<b>Discount group</b>	<b>105</b>

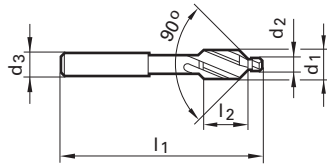

Code no.	d1	d2	d3	l1	l2	thread		Unit price in €
	mm	mm	mm	mm	mm			
6.600	6.600	3.400	5.000	71.00	14.00	M 3	3	<b>39.50</b>
7.600	7.600	3.900	5.000	71.00	14.00	M 3,5	3	42.00
9.000	9.000	4.500	8.000	80.00	18.00	M 4	3	<b>39.00</b>
11.000	11.000	5.500	8.000	80.00	18.00	M 5	3	<b>38.50</b>
13.000	13.000	6.600	12.500	100.00	22.00	M 6	3	<b>46.00</b>
17.200	17.200	9.000	12.500	100.00	22.00	M 8	3	<b>60.00</b>
21.500	21.500	11.000	12.500	100.00	22.00	M10	3	<b>83.00</b>

HSS, HSS-E and  
carbide countersinks

- bright
- steam tempered
- nitrided
- TiAlN
- TiAlN nanoA
- Carbo
- TiN



# 90° countersinks for tapping size holes

HSS

DIN  
1866

Cyl

right hand spiral flutes  
with fixed pilot  
Ø 19.00 mm to Guhring standard

<b>Guhring no.</b>	<b>438</b>
<b>P (N/mm<sup>2</sup>)</b>	<b>1000</b>
<b>M</b>	○
<b>K</b>	●
<b>N</b>	●
<b>S</b>	○
<b>H (HRC)</b>	
<b>Surface finish</b>	○
<b>Discount group</b>	<b>105</b>

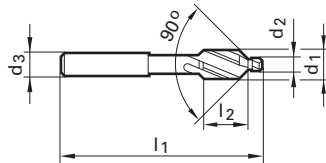

Code no.	d1	d2	d3	l1	l2	thread	
	mm	mm	mm	mm	mm		
6.000	6.000	2.500	5.000	71.00	14.00	M 3	3
7.000	7.000	2.900	5.000	71.00	14.00	M 3,5	3
8.000	8.000	3.300	5.000	71.00	14.00	M 4	3
10.000	10.000	4.200	8.000	80.00	18.00	M 5	3
11.500	11.500	5.000	8.000	80.00	18.00	M 6	3
15.000	15.000	6.800	12.500	100.00	22.00	M 8	3
19.000	19.000	8.500	12.500	100.00	22.00	M10	3

Unit price in €
<b>35.50</b>
44.00
<b>44.00</b>
<b>48.00</b>
<b>52.00</b>
<b>72.00</b>
116.00

HSS, HSS-E and carbide countersinks

- bright
- steam tempered
- nitrided
- TiAlN
- TiAlN nanoA
- Carbo
- TiN

# 120° countersinks

HSS

DIN 347

Cyl

Multi-fluted  
straight-fluted  
and relief-ground  
≤ 12.50 mm and Ø 20.00 mm to Guhring  
standard

A

<b>Guhring no.</b>	<b>478</b>
<b>P (N/mm<sup>2</sup>)</b>	<b>1400</b>
<b>M</b>	○
<b>K</b>	●
<b>N</b>	●
<b>S</b>	○
<b>H (HRC)</b>	
<b>Surface finish</b>	
<b>Discount group</b>	<b>105</b>

R

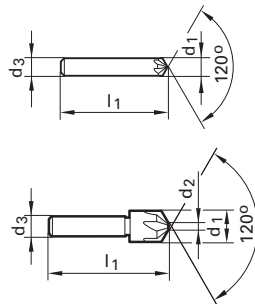

Code no.	d1	d3	l1	d2		Unit price in €
	mm	mm	mm	mm		
8.000	8.000	8.000	42.00	2.000	5	23.00
12.500	12.500	8.000	42.00	2.000	5	28.50
16.000	16.000	10.000	53.00	3.200	7	39.50
20.000	20.000	10.000	56.00	5.000	7	55.00

HSS, HSS-E and  
carbide countersinks

- bright
- steam tempered
- nitrided
- TiAlN
- TiAlN nanoA
- Carbo
- TiN

# 120° countersinks

# HSS



three-fluted  
similar DIN 347  
radial relief ground

<b>Guhring no.</b>	<b>480</b>
<b>P (N/mm<sup>2</sup>)</b>	<b>1000</b>
<b>M</b>	○
<b>K</b>	●
<b>N</b>	●
<b>S</b>	○
<b>H (HRC)</b>	
<b>Surface finish</b>	○
<b>Discount group</b>	<b>105</b>

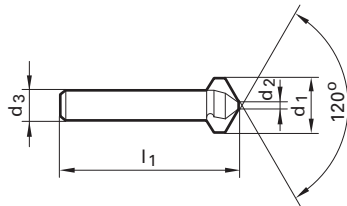

Code no.	d1	d3	l1	d2	
	mm	mm	mm	mm	
16.000	16.000	10.000	53.00	4.000	3

Unit price in €
30.50

HSS, HSS-E and carbide countersinks

- bright
- steam tempered
- nitrided
- TiAlN
- TiAlN nanoA
- Carbo
- TiN

# 120° countersinks

HSS



three-fluted  
similar DIN 347  
radial relief ground



<b>Guhring no.</b>	<b>481</b>
<b>P (N/mm²)</b>	<b>1000</b>
<b>M</b>	○
<b>K</b>	●
<b>N</b>	●
<b>S</b>	○
<b>H (HRC)</b>	
<b>Surface finish</b>	●
<b>Discount group</b>	<b>105</b>

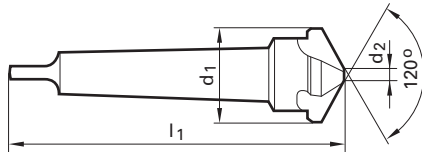

Code no.	d1	MK	l1	d2	
	mm			mm	

25.000	25.000	2	112.00	6.300	3
40.000	40.000	3	140.00	12.500	3

Unit price in €
-----------------

67.00
126.00

○ bright

● steam tempered

● nitrided

● TiAlN

● TiAlN nanoA

● Carbo

● TiN

# 120° countersinks

HSS

DIN 347



Multi-fluted straight-fluted and relief-ground ≤ 20.00 mm and Ø 100.00 mm to Guhring standard

B

<b>Guhring no.</b>	<b>479</b>
<b>P (N/mm²)</b>	<b>1400</b>
<b>M</b>	○
<b>K</b>	●
<b>N</b>	●
<b>S</b>	○
<b>H (HRC)</b>	
<b>Surface finish</b>	●
<b>Discount group</b>	<b>105</b>

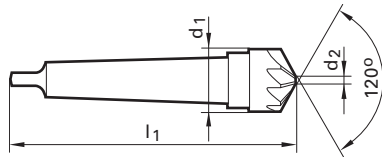

Code no.	d1	MK	l1	d2	
	mm			mm	
25.000	25.000	2	112.00	7.000	9
40.000	40.000	3	140.00	12.000	11
63.000	63.000	4	170.00	20.000	15
100.000	100.000	4	200.00	31.500	17

Unit price in €
108.00
189.00
468.00
1680.00

HSS, HSS-E and carbide countersinks

- bright
- steam tempered
- nitrided
- TiAlN
- TiAlN nanoA
- Carbo
- TiN

# Counterbores with fixed pilots for fine tolerances

	HSS	HSS
<b>Guhring no.</b>	<b>482</b>	<b>324</b>
<b>P (N/mm<sup>2</sup>)</b>	<b>1000</b>	<b>1000</b>
<b>M</b>	○	○
<b>K</b>	●	●
<b>N</b>	●	○
<b>S</b>	○	○
<b>H (HRC)</b>		
<b>Surface finish</b>	○	Ⓢ
<b>Discount group</b>	<b>105</b>	<b>105</b>

DIN 373

Cyl

right hand spiral flutes with fixed pilot

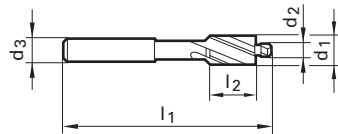

Code no.	d1	d2	d3	l1	l2	for thread	
	mm	mm	mm	mm	mm		
2.200	2.200	1.100	2.200	45.00	7.00	M 1	2
2.500	2.500	1.300	2.500	45.00	7.00	M 1,2	2
3.800	3.800	1.800	3.800	56.00	10.00	M 1,7	2
4.300	4.300	2.200	4.300	56.00	10.00	M 2	2
5.500	5.500	2.800	5.000	71.00	14.00	M 2,6	3
6.000	6.000	3.200	5.000	71.00	14.00	M 3	3
6.500	6.500	3.700	5.000	71.00	14.00	M 3,5	3
8.000	8.000	4.300	5.000	71.00	14.00	M 4	3
10.000	10.000	5.300	8.000	80.00	18.00	M 5	3
11.000	11.000	6.400	8.000	80.00	18.00	M 6	3
15.000	15.000	8.400	12.500	100.00	22.00	M 8	3
18.000	18.000	10.500	12.500	100.00	22.00	M10	3
20.000	20.000	13.000	12.500	100.00	22.00	M12	3

Unit price in €	
25.50	
25.50	
26.50	
<b>29.00</b>	
<b>31.50</b>	
<b>19.70</b>	
26.00	
<b>17.10</b>	<b>44.00</b>
<b>18.30</b>	<b>46.50</b>
<b>19.90</b>	<b>43.50</b>
<b>30.50</b>	<b>70.00</b>
<b>36.50</b>	<b>83.00</b>
<b>39.50</b>	<b>91.00</b>

HSS, HSS-E and carbide countersinks

○ bright   ● steam tempered   ● nitrided   ● TiAN   ● TiAN nanoA   ● Carbo   ● TiN

# Counterbores with fixed pilots for fine tolerances

HSS



right hand spiral flutes  
with fixed pilot

For fine tolerance clearance holes to DIN ISO 273

<b>Guhring no.</b>	<b>485</b>
<b>P (N/mm<sup>2</sup>)</b>	<b>1000</b>
<b>M</b>	○
<b>K</b>	●
<b>N</b>	●
<b>S</b>	○
<b>H (HRC)</b>	
<b>Surface finish</b>	●
<b>Discount group</b>	<b>105</b>

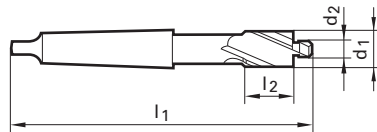

Code no.	d1	d2	MK	l1	l2	for thread	
	mm	mm					
18.000	18.000	10.500	2	150.00	25.00	M10	3
20.000	20.000	13.000	2	150.00	25.00	M12	3
24.000	24.000	15.000	2	162.00	30.00	M14	3
26.000	26.000	17.000	3	192.00	35.00	M16	3
30.000	30.000	19.000	3	192.00	35.00	M18	3
33.000	33.000	21.000	3	204.00	40.00	M20	3
40.000	40.000	25.000	3	204.00	40.00	M24	3

Unit price in €
64.00
<b>57.00</b>
<b>67.00</b>
<b>75.00</b>
<b>88.00</b>
<b>104.00</b>
<b>146.00</b>

HSS, HSS-E and  
carbide countersinks

- bright
- steam tempered
- nitrided
- TiAlN
- TiAlN nanoA
- Carbo
- TiN

# Counterbores with fixed pilots for medial tolerances

	HSS	HSS
<b>Guhring no.</b>	<b>483</b>	<b>325</b>
<b>P (N/mm<sup>2</sup>)</b>	<b>1000</b>	<b>1000</b>
<b>M</b>	○	○
<b>K</b>	●	●
<b>N</b>	●	○
<b>S</b>	○	○
<b>H (HRC)</b>		
<b>Surface finish</b>	○	Ⓢ
<b>Discount group</b>	<b>105</b>	<b>105</b>

DIN 373

Cyl

right hand spiral flutes with fixed pilot

For countersinks to DIN 974, part 1

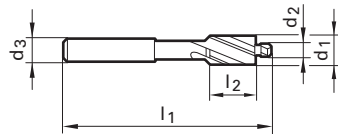

Code no.	d1	d2	d3	l1	l2	for thread	
	mm	mm	mm	mm	mm		
6.000	6.000	3.400	5.000	71.00	14.00	M 3	3
8.000	8.000	4.500	5.000	71.00	14.00	M 4	3
10.000	10.000	5.500	8.000	80.00	18.00	M 5	3
11.000	11.000	6.600	8.000	80.00	18.00	M 6	3
15.000	15.000	9.000	12.500	100.00	22.00	M 8	3
18.000	18.000	11.000	12.500	100.00	22.00	M10	3
20.000	20.000	13.500	12.500	100.00	22.00	M12	3

Unit price in €	
<b>19.50</b>	48.00
<b>17.10</b>	<b>44.00</b>
<b>18.50</b>	<b>40.00</b>
<b>19.00</b>	<b>43.50</b>
<b>30.50</b>	<b>70.00</b>
<b>36.50</b>	<b>83.00</b>
<b>39.50</b>	

HSS, HSS-E and carbide countersinks

○ bright    ● steam tempered    ● nitrided    ● TiAlN    ● TiAlN nanoA    ● Carbo    ● TiN



# Counterbores with fixed pilots for medial tolerances

HSS



right hand spiral flutes  
with fixed pilot

For countersinks to DIN 974, part 1  
For fine tolerance clearance holes to DIN ISO 273

**Guhring no.** 486

**P (N/mm<sup>2</sup>)** 1000

**M** ○

**K** ●

**N** ●

**S** ○

**H (HRC)**

**Surface finish** ●

**Discount group** 105

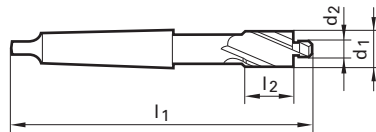

Code no.	d1	d2	MK	l1	l2	for thread	
	mm	mm					
18.000	18.000	11.000	2	150.00	25.00	M10	3
20.000	20.000	13.500	2	150.00	25.00	M12	3
24.000	24.000	15.500	2	162.00	30.00	M14	3
26.000	26.000	17.500	3	192.00	35.00	M16	3
33.000	33.000	22.000	3	204.00	40.00	M20	3
40.000	40.000	26.000	3	204.00	40.00	M24	3

Unit price in €

62.00

57.00

80.00

75.00

104.00

146.00

○ bright

● steam tempered

● nitrided

● TiAlN

● TiAlN nanoA

● Carbo

● TiN

# Counterbores with fixed pilots for tapping size holes

	HSS	HSS
<b>Guhring no.</b>	<b>484</b>	<b>326</b>
<b>P (N/mm<sup>2</sup>)</b>	<b>1000</b>	<b>1000</b>
<b>M</b>	○	○
<b>K</b>	●	●
<b>N</b>	●	○
<b>S</b>	○	○
<b>H (HRC)</b>		
<b>Surface finish</b>	○	Ⓢ
<b>Discount group</b>	<b>105</b>	<b>105</b>

DIN 373

Cyl

right hand spiral flutes with fixed pilot

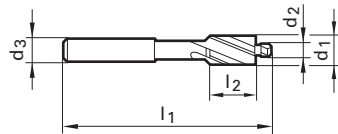

Code no.	d1	d2	d3	l1	l2	for thread	
	mm	mm	mm	mm	mm		
6.000	6.000	2.500	5.000	71.00	14.00	M 3	3
8.000	8.000	3.300	5.000	71.00	14.00	M 4	3
10.000	10.000	4.200	8.000	80.00	18.00	M 5	3
11.000	11.000	5.000	8.000	80.00	18.00	M 6	3
15.000	15.000	6.800	12.500	100.00	22.00	M 8	3
18.000	18.000	8.500	12.500	100.00	22.00	M10	3
20.000	20.000	10.200	12.500	100.00	22.00	M12	3

Unit price in €	
<b>26.00</b>	<b>56.00</b>
<b>23.50</b>	<b>51.00</b>
<b>22.50</b>	56.00
<b>25.00</b>	58.00
<b>37.50</b>	
<b>45.50</b>	111.00
<b>54.00</b>	

HSS, HSS-E and carbide countersinks

- bright
- steam tempered
- nitrided
- TiAlN
- TiAlN nanoA
- Carbo
- TiN

# Counterbores with fixed pilots for tapping size holes

HSS



right hand spiral flutes  
with fixed pilot

For tapping size holes to DIN 336, page 1

<b>Guhring no.</b>	<b>487</b>
<b>P (N/mm<sup>2</sup>)</b>	<b>1000</b>
<b>M</b>	○
<b>K</b>	●
<b>N</b>	●
<b>S</b>	○
<b>H (HRC)</b>	
<b>Surface finish</b>	●
<b>Discount group</b>	<b>105</b>

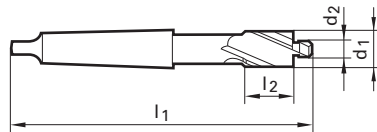

Code no.	d1	d2	MK	l1	l2	for thread	
	mm	mm					
20.000	20.000	10.200	2	150.00	25.00	M12	3
24.000	24.000	12.000	2	162.00	30.00	M14	3
26.000	26.000	14.000	3	192.00	35.00	M16	3

Unit price in €
68.00
80.00
<b>90.00</b>

HSS, HSS-E and carbide countersinks

- bright
- steam tempered
- nitrided
- A TiAlN
- a TiAlN nanoA
- Cb Carbo
- S TiN

# Counterbores with hole for detachable pilot

HSS

DIN 375



right hand spiral flutes

For countersinks to DIN 974, part 1 to suit detachable pilot:  
 Guhring no. 464 for fine tolerances  
 Guhring no. 465 for medial tolerances  
 Guhring no. 466 for tapping size holes

<b>Guhring no.</b>	<b>463</b>
<b>P (N/mm<sup>2</sup>)</b>	<b>1000</b>
<b>M</b>	○
<b>K</b>	●
<b>N</b>	●
<b>S</b>	○
<b>H (HRC)</b>	
<b>Surface finish</b>	●
<b>Discount group</b>	<b>105</b>

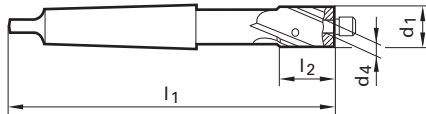

Code no.	d1	MK	d4 H8	l1	l2	
	mm		mm			
15.000	15.000	2	4.000	132.00	22.00	3
18.000	18.000	2	5.000	140.00	25.00	3
20.000	20.000	2	5.000	140.00	25.00	3
24.000	24.000	2	6.000	150.00	30.00	3
26.000	26.000	3	8.000	180.00	35.00	3
30.000	30.000	3	8.000	180.00	35.00	3
33.000	33.000	3	10.000	190.00	40.00	3
63.000	63.000	4	16.000	250.00	63.00	4

Unit price in €
<b>78.00</b>
95.00
<b>83.00</b>
<b>93.00</b>
<b>107.00</b>
<b>133.00</b>
<b>170.00</b>
650.00

HSS, HSS-E and carbide countersinks

- bright
- steam tempered
- nitrided
- TiAN
- TiAN nanoA
- Carbo
- TiN

DIN  
1868

<b>Guhring no.</b>	<b>464</b>
<b>P (N/mm<sup>2</sup>)</b>	
<b>M</b>	
<b>K</b>	
<b>N</b>	
<b>S</b>	
<b>H (HRC)</b>	
<b>Surface finish</b>	○
<b>Discount group</b>	<b>105</b>

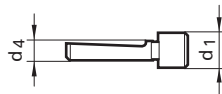

Code no.	d1	d4	for	G	Unit price in €
	mm	mm	mm		
8.404	8.400	4.000	15,0	M8	29.00
8.405	8.400	5.000	18,0/20,0	M8	36.00
10.505	10.500	5.000	18,0/20,0	M10	36.00
10.506	10.500	6.000	24,0	M10	39.00
13.005	13.000	5.000	20,0	M12	36.00
13.006	13.000	6.000	24,0	M12	39.00
13.008	13.000	8.000	26,0	M12	42.00
15.006	15.000	6.000	24,0	M14	40.00
15.008	15.000	8.000	26,0/30,0	M14	44.00
17.008	17.000	8.000	26,0/30,0	M16	44.00
17.010	17.000	10.000	33,0	M16	50.00
19.008	19.000	8.000	30,0	M18	44.00
19.010	19.000	10.000	33,0/36,0	M18	50.00
21.010	21.000	10.000	33,0/36,0/40,0	M20	50.00
23.010	23.000	10.000	36,0/40,0	M22	53.00
23.012	23.000	12.000	43,0	M22	74.00
25.010	25.000	10.000	40,0	M24	53.00
25.012	25.000	12.000	43,0/46,0	M24	85.00

HSS, HSS-E and carbide countersinks

- bright
- steam tempered
- nitrided
- TiAlN
- TiAlN nanoA
- Carbo
- TiN

DIN  
1868

Guhring no. 465

P (N/mm<sup>2</sup>)

M

K

N

S

H (HRC)

Surface finish

Discount group



105

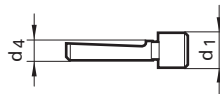

Code no.	d1	d4	for	G	Unit price in €
	mm	mm	mm		
9.004	9.000	4.000	15,0	M8	26.50
9.005	9.000	5.000	18,0/20,0	M8	36.00
11.005	11.000	5.000	18,0/20,0	M10	34.00
11.006	11.000	6.000	24,0	M10	39.00
13.505	13.500	5.000	20,0	M12	34.00
13.506	13.500	6.000	24,0	M12	39.00
13.508	13.500	8.000	26,0	M12	42.00
15.506	15.500	6.000	24,0	M14	39.00
15.508	15.500	8.000	26,0/30,0	M14	42.00
17.508	17.500	8.000	26,0/30,0	M16	42.00
17.510	17.500	10.000	33,0	M16	50.00
20.008	20.000	8.000	30,0	M18	44.00
20.010	20.000	10.000	33,0/36,0	M18	50.00
22.010	22.000	10.000	33,0/36,0/40,0	M20	50.00
24.010	24.000	10.000	36,0/40,0	M22	53.00
24.012	24.000	12.000	43,0	M22	74.00
26.010	26.000	10.000	40,0	M24	50.00
26.012	26.000	12.000	43,0/46,0	M24	85.00
30.012	30.000	12.000	43,0/46,0	M27	85.00
30.016	30.000	16.000	53,0	M27	110.00
33.012	33.000	12.000	48,0	M30	85.00
33.016	33.000	16.000	53,0/61,0	M30	87.00
36.016	36.000	16.000	53,0/57,0	M33	130.00
39.016	39.000	16.000	57,0/61,0	M36	130.00

HSS, HSS-E and  
carbide countersinks

○ bright

● steam tempered

● nitrided

● TiAlN

● TiAlN nanoA

● Carbo

● TiN

DIN  
1868

<b>Guhring no.</b>	<b>466</b>
<b>P (N/mm<sup>2</sup>)</b>	
<b>M</b>	
<b>K</b>	
<b>N</b>	
<b>S</b>	
<b>H (HRC)</b>	
<b>Surface finish</b>	○
<b>Discount group</b>	<b>105</b>

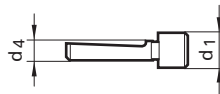

Code no.	d1	d4	for	G	Unit price in €
	mm	mm	mm		
6.804	6.800	4.000	15,0	M8	29.00
6.805	6.800	5.000	18,0/20,0	M8	36.00
8.505	8.500	5.000	18,0/20,0	M10	36.00
8.506	8.500	6.000	24,0	M10	40.00
10.205	10.200	5.000	20,0	M12	34.00
10.206	10.200	6.000	24,0	M12	40.00
10.208	10.200	8.000	26,0	M12	44.00
12.006	12.000	6.000	24,0	M14	40.00
12.008	12.000	8.000	26,0/30,0	M14	42.00
14.008	14.000	8.000	26,0/30,0	M16	44.00
14.010	14.000	10.000	30,0	M16	50.00
15.508	15.500	8.000	30,0	M18	42.00
15.510	15.500	10.000	33,0/36,0	M18	50.00
17.510	17.500	10.000	33,0/36,0/40,0	M20	50.00
19.510	19.500	10.000	36,0/40,0	M22	50.00
19.512	19.500	12.000	43,0	M22	74.00
21.010	21.000	10.000	40,0	M24	50.00
21.012	21.000	12.000	43,0/46,0	M24	74.00
24.012	24.000	12.000	43,0/46,0	M27	74.00
24.016	24.000	16.000	53,0	M27	110.00
26.512	26.500	12.000	48,0	M30	85.00
26.516	26.500	16.000	53,0/61,0	M30	85.00
29.516	29.500	16.000	53,0/57,0	M33	110.00
32.016	32.000	16.000	57,0/61,0	M36	130.00

HSS, HSS-E and carbide countersinks

- bright
- steam tempered
- nitrided
- TiAlN
- TiAlN nanoA
- Carbo
- TiN

# Spot facers

HSS-E

DIN  
1862



right hand spiral flutes  
Morse taper to DIN 228 part 1 form A with tightening  
thread M6

**Guhring no.** 432

**P (N/mm²)** 1000

**M** ○

**K** ●

**N** ●

**S** ○

**H (HRC)**

**Surface finish** ●  
**Discount group** 105

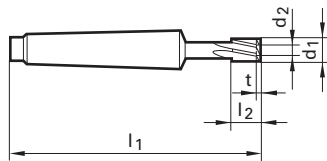

Code no.	d1	d2	MK	l1	l2	t	
	mm	mm					
3.500	3.500		1	80.00	5.00		4
4.500	4.500		1	80.00	5.00		4
5.500	5.500		1	85.00	8.00		4
11.000	11.000	5.000	1	95.00	16.00	1.50	6
13.000	13.000	5.000	1	95.00	16.00	1.50	6

Unit price in €
121.00
124.00
137.00
150.00
132.00

HSS, HSS-E and carbide countersinks

- bright
- steam tempered
- nitrided
- A TiAlN
- a TiAlN nanoA
- Cb Carbo
- S TiN



# Spot facers

HSS-E

DIN  
1862



right hand spiral flutes  
Morse taper to DIN 228 part 1 form A with tightening  
thread M10

**Guhring no.** 433

**P (N/mm<sup>2</sup>)** 1000

**M** ○

**K** ●

**N** ●

**S** ○

**H (HRC)**

**Surface finish** ●  
**Discount group** 105

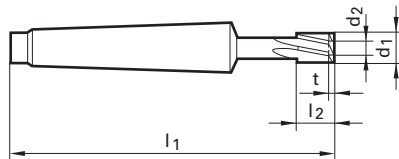

Code no.	d1	d2	MK	l1	l2	t	
	mm	mm					
6.000	6.000		2	112.00	10.00		6
8.000	8.000		2	112.00	10.00		6
10.000	10.000	5.000	2	112.00	16.00	1.50	6
12.000	12.000	5.000	2	112.00	16.00	1.50	6
13.000	13.000	5.000	2	112.00	16.00	1.50	6
14.000	14.000	6.000	2	125.00	20.00	2.00	6
15.000	15.000	6.000	2	125.00	20.00	2.00	6
16.000	16.000	8.000	2	125.00	20.00	2.00	8
18.000	18.000	10.000	2	125.00	20.00	2.00	8
23.000	23.000	12.000	2	125.00	25.00	3.00	8
25.000	25.000	12.000	2	125.00	25.00	3.00	8
27.000	27.000	15.000	2	125.00	25.00	3.50	8
28.000	28.000	15.000	2	125.00	25.00	3.50	8
29.000	29.000	15.000	2	125.00	25.00	3.50	8
30.000	30.000	15.000	2	125.00	25.00	3.50	8

Unit price in €

**144.00**

131.00

**131.00**

**155.00**

156.00

166.00

**158.00**

**164.00**

**164.00**

173.00

190.00

286.00

232.00

332.00

232.00

HSS, HSS-E and  
carbide countersinks

○ bright

● steam tempered

● nitrided

● TiAlN

● TiAlN nanoA

● Carbo

● TiN

# Spot facers

HSS-E

DIN  
1862



right hand spiral flutes  
Morse taper to DIN 228 part 1 form A with tightening  
thread M12

**Guhring no.** 434

**P (N/mm<sup>2</sup>)** 1000

**M** ○

**K** ●

**N** ●

**S** ○

**H (HRC)**

**Surface finish** ●  
**Discount group** 105

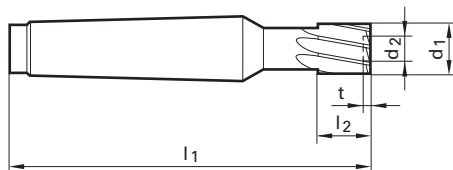

Code no.	d1	d2	MK	l1	l2	t	
	mm	mm					
10.000	10.000	5.000	3	125.00	16.00	1.50	6
11.000	11.000	5.000	3	125.00	16.00	1.50	6
13.000	13.000	5.000	3	125.00	16.00	1.50	6
14.000	14.000	6.000	3	135.00	20.00	2.00	6
18.000	18.000	10.000	3	135.00	20.00	2.00	8
20.000	20.000	12.000	3	145.00	25.00	3.00	8
22.000	22.000	12.000	3	145.00	25.00	3.00	8
23.000	23.000	12.000	3	145.00	25.00	3.00	8
25.000	25.000	12.000	3	145.00	25.00	3.00	8
27.000	27.000	15.000	3	145.00	25.00	3.50	8
28.000	28.000	15.000	3	145.00	25.00	3.50	8
29.000	29.000	15.000	3	145.00	25.00	3.50	8
30.000	30.000	15.000	3	145.00	25.00	3.50	8

Unit price in €
189.00
216.00
187.00
187.00
202.00
208.00
197.00
222.00
222.00
222.00
222.00
302.00
222.00

HSS, HSS-E and  
carbide countersinks

○ bright   ● steam tempered   ● nitrided   ● TiAlN   ● TiAlN nanoA   ● Carbo   ● TiN

# Spot facers

HSS-E

DIN  
1862



right hand spiral flutes  
Morse taper to DIN 228 part 1 form A with tightening  
thread M16

**Guhring no.** 435

**P (N/mm<sup>2</sup>)** 1000

**M** ○

**K** ●

**N** ●

**S** ○

**H (HRC)**

**Surface finish** ●  
**Discount group** 105

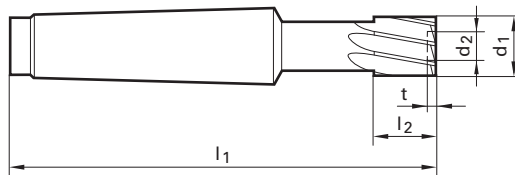

Code no.	d1	d2	MK	l1	l2	t	
	mm	mm					
20.000	20.000	12.000	4	175.00	25.00	3.00	8
21.000	21.000	12.000	4	175.00	25.00	3.00	8
22.000	22.000	12.000	4	175.00	25.00	3.00	8
23.000	23.000	12.000	4	175.00	25.00	3.00	8
24.000	24.000	12.000	4	175.00	25.00	3.00	8
25.000	25.000	12.000	4	175.00	25.00	3.00	8
26.000	26.000	15.000	4	175.00	25.00	3.50	8
27.000	27.000	15.000	4	175.00	25.00	3.50	8
28.000	28.000	15.000	4	175.00	25.00	3.50	8
29.000	29.000	15.000	4	175.00	25.00	3.50	8
30.000	30.000	15.000	4	175.00	25.00	3.50	8
31.000	31.000	15.000	4	175.00	25.00	3.50	8
33.000	33.000	16.000	4	195.00	32.00	3.50	10
34.000	34.000	16.000	4	195.00	32.00	3.50	10
35.000	35.000	16.000	4	195.00	32.00	3.50	10
37.000	37.000	18.000	4	195.00	32.00	4.00	10
38.000	38.000	18.000	4	195.00	32.00	4.00	10
39.000	39.000	18.000	4	195.00	32.00	4.00	10
41.000	41.000	20.000	4	210.00	40.00	4.00	10
43.000	43.000	20.000	4	210.00	40.00	4.00	10
44.000	44.000	20.000	4	210.00	40.00	4.00	10
45.000	45.000	22.000	4	210.00	40.00	4.50	10
46.000	46.000	22.000	4	210.00	40.00	4.50	10
47.000	47.000	22.000	4	210.00	40.00	4.50	10
48.000	48.000	22.000	4	210.00	40.00	4.50	10

Unit price in €
264.00
308.00
262.00
326.00
326.00
338.00
296.00
426.00
348.00
348.00
348.00
348.00
356.00
340.00
356.00
308.00
356.00
356.00
406.00
406.00
354.00
402.00
600.00
600.00
520.00

HSS, HSS-E and  
carbide countersinks

○ bright

● steam tempered

● nitrided

● TiAlN

● TiAlN nanoA

● Carbo

● TiN

# EW 100 G de-burring fork

## Advantages

- cost-efficient, as costly and time-consuming manual re-working is not necessary.
- universal tooling for milling, turning and robotic applications. The range of 0.25 mm enables the application of our de-burring fork in holes with large tolerances. Reducing set-up time and cost!
- increased production. De-burring fork EW 100 G de-burrs automatically with one set-up and short cycle times.

## Operation

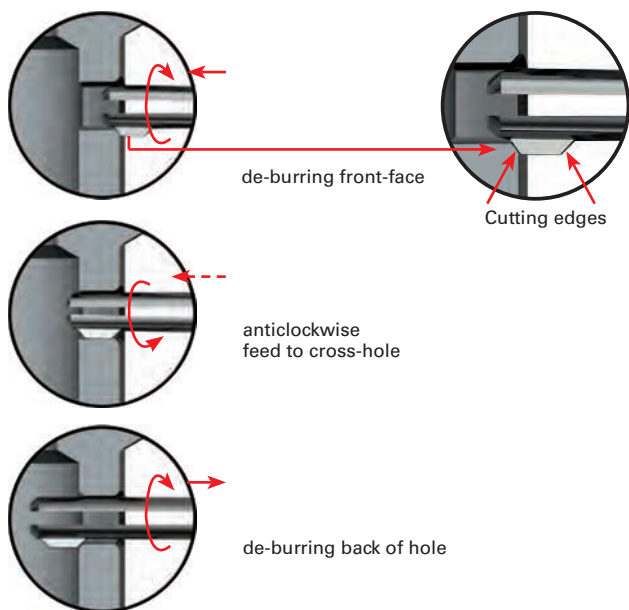

## Application examples

### 1st example

Workpiece with cross-hole

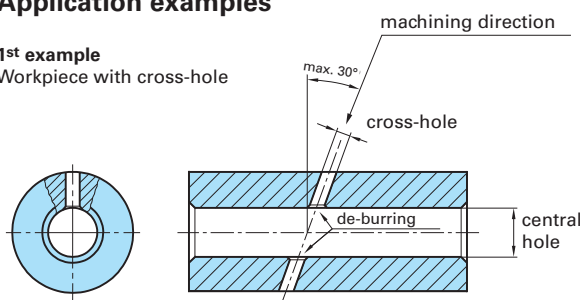

Please note when machining workpieces with cross-holes:  
 – the diameter of the cross-hole must be maximal 35% of the central hole  
 – the diameter of the cross-hole must be 40% larger than the cutting length  $l_4$

### 2nd example

Workpiece with multi-interrupted cut

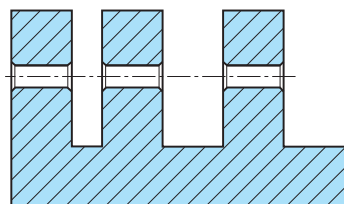

## Step by step:

The automatically internal and external de-burring with de-burring fork EW 100 G is an easy and cost saving alternative to common, extensive manual operations. Just one tool is required for all machining steps.

## Universal application:

The new ex-stock de-burring fork machines workpieces with one cross-hole as well as workpieces with multi-interrupted cut and produces high quality de-burred faces and ends of the hole.

## De-burring fork cutting parameters

Ø range (mm)	$v_c$ m/min	$f_u$ (mm)
< Ø 4	8 - 10	0.1 - 0.2
Ø 4 - < Ø 6	10 - 14	0.1 - 0.2
6 - Ø 8	14 - 20	0.1 - 0.2

## Important:

Please note that the cutting parameters are recommendations. They can be adjusted up or down.

# De-burring forks

Solid carbide



with shank  
to DIN 6535  
for holding in hydraulic chucks and shrink fit chucks  
with internal coolant supply

for internal and external de-burring  
universal for tooling, milling, turning and robotic applications.

**Guhring no.** 4101

**P (N/mm<sup>2</sup>)**

**M**

**K**

**N**

**S**

**H (HRC)**

**Surface finish**

**Discount group**

○  
**Net price**

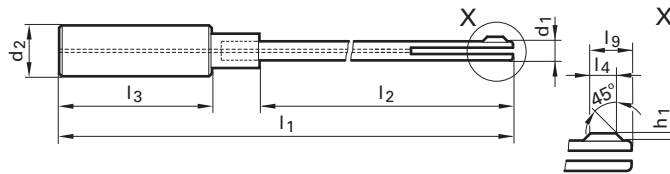

Code no.	nom. Ø	d1	for Ø range	d2	l1	l2	l3	l4	l9	h1
	mm	mm	mm	mm	mm	mm	mm	mm	mm	mm
2.000	2.000	1.900	1.91 - 2.15	6.000	120.00	69.00	36.00	1.00	2.05	0.35
2.250	2.250	2.100	2.16 - 2.40	6.000	120.00	69.00	36.00	1.50	2.60	0.40
2.500	2.500	2.400	2.41 - 2.70	6.000	120.00	69.00	36.00	1.50	2.90	0.40
2.750	2.750	2.600	2.71 - 2.90	6.000	130.00	79.00	36.00	1.50	2.95	0.45
3.000	3.000	2.900	2.91 - 3.25	6.000	130.00	79.00	36.00	2.00	3.65	0.45
3.500	3.500	3.200	3.26 - 3.60	10.000	135.00	80.00	40.00	2.00	3.80	0.60
4.000	4.000	3.600	3.61 - 4.25	10.000	135.00	80.00	40.00	2.00	4.10	0.70
4.500	4.500	4.200	4.26 - 4.75	10.000	135.00	80.00	40.00	2.50	4.60	0.70
5.000	5.000	4.700	4.76 - 5.30	10.000	145.00	80.00	40.00	2.50	4.85	0.75
5.500	5.500	5.200	5.31 - 5.80	10.000	145.00	90.00	40.00	2.50	4.85	0.75
6.000	6.000	5.600	5.81 - 6.20	10.000	155.00	90.00	40.00	3.00	5.80	0.80
6.500	6.500	6.000	6.21 - 6.70	16.000	165.00	102.00	48.00	3.00	5.90	0.90
7.000	7.000	6.500	6.71 - 7.10	16.000	165.00	102.00	48.00	3.00	5.85	0.85
7.500	7.500	6.900	7.11 - 7.60	16.000	165.00	102.00	48.00	3.50	6.95	0.95
8.000	8.000	7.300	7.61 - 8.05	16.000	165.00	102.00	48.00	3.50	7.00	1.00

Availability
●
●
●
○
●
○
●
●
●
●
●
○
●

De-burring tools

- bright
- steam tempered
- nitrided
- TiAN
- TiAN nanoA
- Carbo
- TiN

# De-burring forks

Solid carbide



with continuous straight shank for holding in collet chucks with internal coolant supply

for internal and external de-burring universal for tooling, milling, turning and robotic applications.

<b>Guhring no.</b>	<b>4100</b>
<b>P (N/mm<sup>2</sup>)</b>	
<b>M</b>	
<b>K</b>	
<b>N</b>	
<b>S</b>	
<b>H (HRC)</b>	
<b>Surface finish</b>	○
<b>Discount group</b>	○ <b>Net price</b>
	Ⓜ

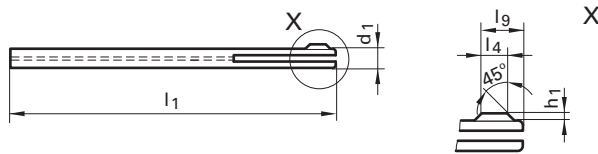

Code no.	nom. Ø	d1	for Ø range	l1	l4	l9	h1
	mm	mm	mm	mm	mm	mm	mm
2.000	2.000	1.900	1.91 - 2.15	80.00	1.00	2.05	0.35
2.250	2.250	2.100	2.16 - 2.40	80.00	1.50	2.60	0.40
2.500	2.500	2.400	2.41 - 2.70	80.00	1.50	2.90	0.40
2.750	2.750	2.600	2.71 - 2.90	90.00	1.50	2.95	0.45
3.000	3.000	2.900	2.91 - 3.25	90.00	2.00	3.65	0.45
3.500	3.500	3.200	3.26 - 3.60	90.00	2.00	3.80	0.60
4.000	4.000	3.600	3.61 - 4.25	90.00	2.00	4.10	0.70
4.500	4.500	4.200	4.26 - 4.75	90.00	2.50	4.60	0.70
5.000	5.000	4.700	4.76 - 5.30	100.00	2.50	4.85	0.75
5.500	5.500	5.200	5.31 - 5.80	100.00	2.50	4.85	0.75
6.000	6.000	5.600	5.81 - 6.20	110.00	3.00	5.80	0.80
6.500	6.500	6.000	6.21 - 6.70	110.00	3.00	5.90	0.90
7.000	7.000	6.500	6.71 - 7.10	110.00	3.00	5.85	0.85
7.500	7.500	6.900	7.11 - 7.60	110.00	3.50	6.95	0.95
8.000	8.000	7.300	7.61 - 8.05	110.00	3.50	7.00	1.00

Availability
●
●
●
●
●
●
●
●
●
●
●
○
○
●

De-burring tools

- bright
- steam tempered
- nitrided
- A TiAlN
- a TiAlN nanoA
- Cb Carbo
- S TiN

# EW 100 VR front/back de-burrer

Guhring's solid carbide EW 100 VR front/back de-burrer with TiAlN-coating as a standard tool enables de-burring as well as chamfering of hole entry and exit with a 90° angle. EW 100 VR possesses a milling head with a

front and back cutting region. To de-burr or chamfer the tool performs a circular milling movement along the hole edge or contour.

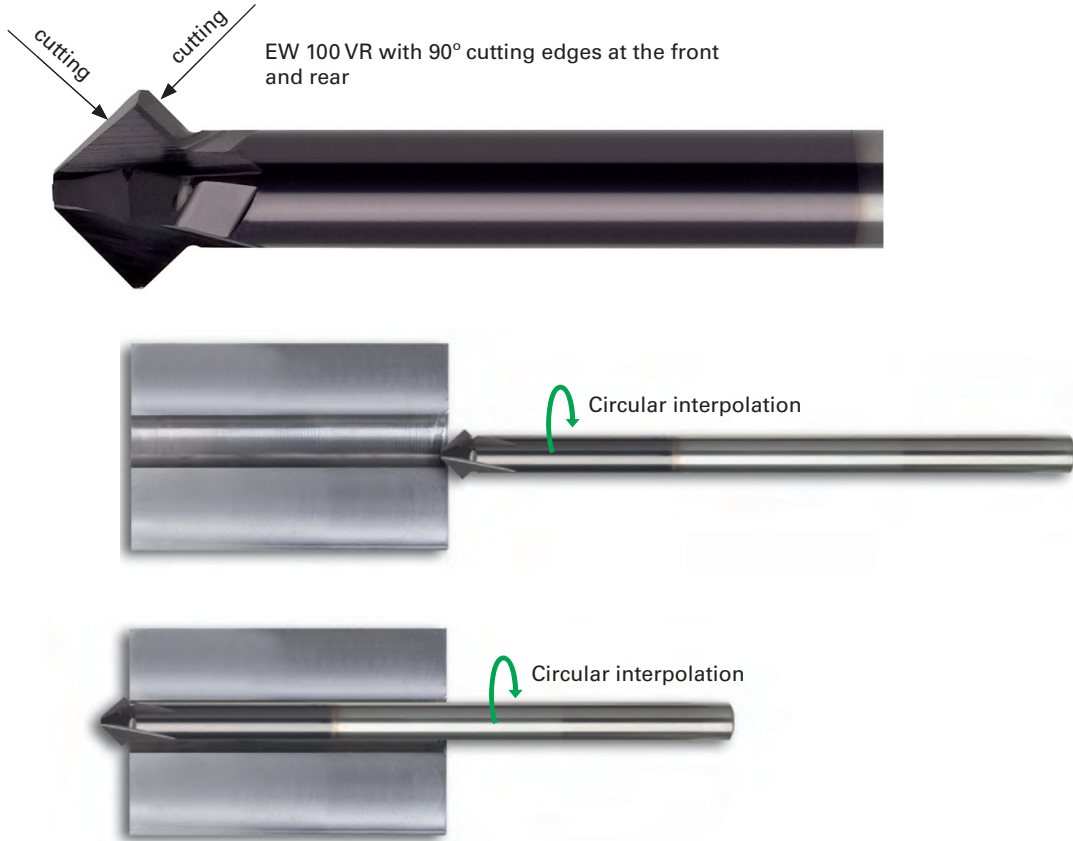

### Cutting parameters for front/back de-burrer

Material group	Tens. strength MPa (N/mm <sup>2</sup> )	Hardness	v <sub>c</sub> (m/min)	Feed col. no.
Steels	< 850		120 - 200	71
	850-1200		100 - 180	71
	> 1200		80 - 140	71
Hardened steels		< 54 HRC	60 - 120	71
		54-60 HRC	40 - 80	71
Stainless/acid-resistant steels	< 850		80 - 120	71
Nickel-based alloys	< 1300		30 - 60	71
Ti-alloys	< 1300		50 - 100	71
Cast materials		< 240 HB30	120 - 180	72
		> 240 HB30	100 - 160	72
Al wrought alloys < 3% Si			150 - 250	72
Al cast alloys > 3% Si			100 - 200	72
Magnesium alloys			150 - 250	72
Non-ferrous alloys	< 850		30 - 200	72

### Feed column no. (mm/rev)

Ø	71	72
≤ 3.00	0.060	0.080
4.00	0.100	0.125
5.00	0.100	0.125
6.30	0.125	0.160
8.00	0.160	0.200
10.00	0.200	0.250
12.50	0.200	0.250

### Important:

Please note that the cutting parameters are recommendations. They can be adjusted up or down.

# Front/back deburrer 90°

Solid carbide



with shank  
to DIN 6535  
for holding in hydraulic chucks and shrink fit chucks

for internal and external de-burring  
of holes and contours

Guhring no.

495

P (N/mm<sup>2</sup>)

1400

M



K



N



S



H (HRC)

60

Surface finish



Discount group

120

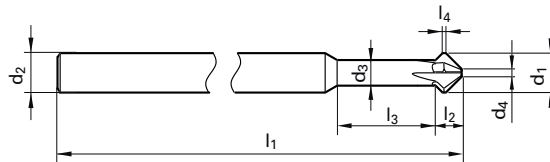

Code no.	d1 h8	d2 h6	d3	d4	l1	l2	l3	l4	
	mm	mm	mm	mm	mm	mm	mm	mm	
3.000	3.000	4.000	0.600	2.200	75.00	2.10	10.00	0.50	4
4.000	4.000	4.000	0.800	2.900	75.00	2.70	13.00	0.50	4
5.000	5.000	5.000	1.000	3.900	75.00	3.00	15.00	0.50	4
6.000	6.000	6.000	1.200	3.900	100.00	3.50	15.00	0.50	4
8.000	8.000	6.000	1.600		100.00	4.70		0.50	4
10.000	10.000	6.000	2.000		100.00	6.50		0.50	4
12.000	12.000	6.000	2.400		100.00	8.30		0.50	4

Availability

De-burring tools

- bright
- steam tempered
- nitrided
- TiAN
- TiAN nanoA
- Carbo
- TiN





# NAVIGATOR TECHNICAL SECTION

Tools with bold feed column no. are preferred choice.

For blind holes with close diameter tolerances choose straight-fluted reamers.

To select the optimal tool and the recommended machining parameters for your application, please also use the electronic version of the GuhringNavigator on the internet: [www.guehring.de](http://www.guehring.de).

- Guhring no.**
- Guhring no.**
- Standard/DIN**
- Tool material**
- Surface finish**
- Form**
- Cooling**

Counter-sink Ø mm	Feed column no.						
	71	72	73	74	75	76	77
	f (mm/rev.)						
< 4.00	0.080	0.100	0.125	0.300	0.500	0.800	1.000
4.00	0.100	0.125	0.160	0.300	0.500	1.000	1.200
5.00	0.100	0.125	0.160	0.400	0.600	1.000	1.400
6.30	0.125	0.160	0.200	0.400	0.700	1.200	1.600
8.00	0.160	0.200	0.250	0.600	1.000	1.800	2.400
10.00	0.200	0.250	0.315	0.600	1.200	1.800	2.400
12.50	0.200	0.250	0.315	0.800	1.200	2.000	2.500
16.00	0.250	0.315	0.400	0.800	1.400	2.200	2.600
20.00	0.315	0.400	0.500	0.800	1.400	2.200	2.600
25.00	0.400	0.500	0.630	1.000	1.600	2.500	3.000
31.50	0.400	0.500	0.630	1.000	2.000	3.000	3.600
40.00	0.500	0.630	0.800	1.200	2.000	3.000	3.600
50.00	0.630	0.800	1.000	1.400	2.200	3.200	3.600
> 50.00	0.800	1.000	1.250	1.600	2.200	3.200	3.600

Coolant:

- Air
- Neat oil
- Soluble oil

Cutting direction:

- right-hand cutting
- left-hand cutting

Material group	Material examples, new description (old description in brackets) Figures in bold = material no. to DIN EN	Tensile str. MPa (N/mm <sup>2</sup> )	Hard- ness	Coolant
Common structural steels	<b>1.0035</b> S185(St33), <b>1.0486</b> P275N(StE285), <b>1.0345</b> P235GH(H1), <b>1.0425</b> P265GH(H2) <b>1.0050</b> E295 (St50-2), <b>1.0070</b> E360 (St70-2), <b>1.8937</b> P500NH (WStE500)	≤500 ≤1000		
Free-cutting steels	<b>1.0718</b> 11SMnPb30 (9SMnPb28), <b>1.0736</b> 11SMn37 (9SMn36) <b>1.0727</b> 46S20 (45S20), <b>1.0728</b> (60S20), <b>1.0757</b> 46SPb20 (45SPb20)	≤850 ≤1000		
Unalloyed heat-treatable steels	<b>1.0402</b> C22, <b>1.1178</b> C30E (Ck30) <b>1.0503</b> C45, <b>1.1191</b> C45E (Ck45) <b>1.0601</b> C60, <b>1.1221</b> C60E (Ck60)	≤700 ≤850 ≤1000		
Alloyed heat-treatable steels	<b>1.5131</b> 50MnSi4, <b>1.7003</b> 38Cr2, <b>1.7030</b> 28Cr4 <b>1.5710</b> 36NiCr6, <b>1.7035</b> 41Cr4, <b>1.7225</b> 42CrMo4	≤1000 ≤1400		
Unalloyed case hard. steels	<b>1.0301</b> (C10), <b>1.1121</b> C10E (Ck10)	≤850		
Alloyed case hardened steels	<b>1.7276</b> 10CrMo11, <b>1.5125</b> 11MnSi6 <b>1.5752</b> 15NiCr13, <b>1.7131</b> 16MnCr5, <b>1.7264</b> 20CrMo5	≤1000 ≤1400		
Nitriding steels	<b>1.8504</b> 34CrAl6 <b>1.8519</b> 31CrMoV9, <b>1.8550</b> 34CrAlNi7	≤1000 ≤1400		
Tool steels	<b>1.1750</b> C75W, <b>1.2067</b> 102Cr6, <b>1.2307</b> 29CrMoV9 <b>1.2080</b> X210Cr12, <b>1.2083</b> X42Cr13, <b>1.2419</b> 105WCr6, <b>1.2767</b> X45NiCrMo4	≤850 ≤1400		
High speed steels	<b>1.3243</b> S 6-5-2-5, <b>1.3343</b> S 6-5-2, <b>1.3344</b> S 6-5-3	≤1400		
Spring steels	<b>1.5026</b> 55Si7, <b>1.7176</b> 55Cr3, <b>1.8159</b> 51CrV4 (51CrV4)		≤350 HB	
Stainless steels, sulphured	<b>1.4005</b> X12CrS13, <b>1.4104</b> X14CrMoS17, <b>1.4105</b> X6CrMoS17, <b>1.4305</b> X8CrNiS18-9	≤900		
austenitic	<b>1.4301</b> X5CrNi18-10 (V2A), <b>1.4541</b> X6CrNiTi18-10, <b>1.4571</b> X6CrNiMoTi 17-12-2 (V4A)	≤1100		
martensitic	<b>1.4057</b> X20CrNi172 (X17CrNi16-2), <b>1.4122</b> X39CrMo17-1, <b>1.4521</b> X2CrMoTi18-2	≤1500		
Hardened steels	-		≤48 HRC ≤66 HRC	
Special alloys	Nimonic, Inconel, Monel, Hastelloy	≤2000		
Cast iron	<b>0.6010</b> EN-GJL-100 (GG10), <b>0.6020</b> EN-GJL-200 (GG20) <b>0.6025</b> EN-GJL-250 (GG25), <b>0.6035</b> EN-GJL-350 (GG35)		≤240 HB ≤350 HB	
Spheroidal graphite iron and malleable cast iron	<b>0.7040</b> EN-GJS-400-15 (GGG40), <b>0.7050</b> EN-GJS-500-7 (GGG50), <b>0.8035</b> EN-GJMW-350-4 (GTW35) <b>0.7060</b> EN-GJS-600-3 (GGG60), <b>0.7070</b> EN-GJS-700-2 (GGG70), <b>0.8170</b> EN-GJMB-700-2 (GTS70)		≤240 HB ≤350 HB	
Chilled cast iron	-		≤350 HB	
Ti and Ti-alloys	<b>3.7024</b> Ti99.5, <b>3.7114</b> TiAl5Sn2.5, <b>3.7124</b> TiCu2 <b>3.7154</b> TiAl6Zr5, <b>3.7165</b> TiAl6V4, <b>3.7184</b> TiAl4Mo4Sn2.5, - TiAl8Mo1V1	≤850 ≤1400		
Aluminium and Al-alloys	<b>3.0255</b> Al99.5, <b>3.2315</b> AlMgSi1, <b>3.3515</b> AlMg1	≤400		
Al wrought alloys	<b>3.0615</b> AlMgSiPb, <b>3.1325</b> AlCuMg1, <b>3.3245</b> AlMg3Si, <b>3.4365</b> AlZnMgCu1.5	≤650		
Al cast alloys ≤ 10 % Si	<b>3.2131</b> G-AlSi5Cu1, <b>3.2153</b> G-AlSi7Cu3, <b>3.2573</b> G-AlSi9	≤600		
≤ 24 % Si	<b>3.2581</b> G-AlSi12, <b>3.2583</b> G-AlSi12Cu, - G-AlSi12CuNiMg	≤600		
Magnesium alloys	<b>3.5200</b> MgMn2, <b>3.5812.05</b> G-MgAl8Zn1, <b>3.5612.05</b> G-MgAl6Zn1	≤400		
Copper, low-alloyed	<b>2.0070</b> SE-Cu, <b>2.1020</b> CuSn6, <b>2.1096</b> G-CuSn5ZnPb	≤500		
Brass, short-chipping	<b>2.0380</b> CuZn39Pb2, <b>2.0401</b> CuZn39Pb3, <b>2.0410</b> CuZn43Pb2	≤600		
long-chipping	<b>2.0250</b> CuZn20, <b>2.0280</b> CuZn33, <b>2.0332</b> CuZn37Pb0.5	≤600		
Bronze, short-chipping	<b>2.1090</b> CuSn7ZnPb, <b>2.1170</b> CuPb5Sn5, <b>2.1176</b> CuPb10Sn <b>2.0790</b> CuNi18Zn19Pb	≤600 ≤850		
Bronze, long-chipping	<b>2.0916</b> CuAl5, <b>2.0960</b> CuAl9Mn, <b>2.1050</b> CuSn10 <b>2.0980</b> CuAl11Ni, <b>2.1247</b> CuBe2	≤850 ≤1000		
Duroplastics	Bakelit, Resopal, Pertinax, Moltopren	≤150		
Thermoplastics	Plexiglass, Hostalen, Novodur, Makralon	≤100		
New cast materials CGI	<b>EN-GJV250</b> (GGV25), <b>EN-GJV350</b> (GGV35) <b>EN-GJV400</b> (GGV40), <b>EN-GJV500</b> (GGV50), SiMo 6		≤220 HB ≤300 HB	
New cast materials ADI	<b>EN-GJS-800-8</b> (ADI800), <b>EN-GJS-1000-5</b> (ADI1000) <b>EN-GJS-1200-2</b> (ADI1200), <b>EN-GJS-1400-1</b> (ADI1400)	≤1000 ≤1400		
Kevlar	Kevlar	≤1000		
Glass, carbon conc. plastics	GRP/CFRP	≤1000		

- bright
- steam tempered
- nitrided
- TiAlN
- TiAlN nanoA
- Carbo
- TiN
- Signum



Tools with bold feed column no. are preferred choice.

For blind holes with close diameter tolerances choose straight-fluted reamers.

To select the optimal tool and the recommended machining parameters for your application, please also use the electronic version of the GuhringNavigator on the internet: [www.guehring.de](http://www.guehring.de).

- Guhring no.**
- Guhring no.**
- Standard/DIN**
- Tool material**
- Surface finish**
- Form**
- Cooling**

Counter-sink Ø mm	Feed column no.						
	71	72	73	74	75	76	77
	f (mm/rev.)						
< 4.00	0.080	0.100	0.125	0.300	0.500	0.800	1.000
4.00	0.100	0.125	0.160	0.300	0.500	1.000	1.200
5.00	0.100	0.125	0.160	0.400	0.600	1.000	1.400
6.30	0.125	0.160	0.200	0.400	0.700	1.200	1.600
8.00	0.160	0.200	0.250	0.600	1.000	1.800	2.400
10.00	0.200	0.250	0.315	0.600	1.200	1.800	2.400
12.50	0.200	0.250	0.315	0.800	1.200	2.000	2.500
16.00	0.250	0.315	0.400	0.800	1.400	2.200	2.600
20.00	0.315	0.400	0.500	0.800	1.400	2.200	2.600
25.00	0.400	0.500	0.630	1.000	1.600	2.500	3.000
31.50	0.400	0.500	0.630	1.000	2.000	3.000	3.600
40.00	0.500	0.630	0.800	1.200	2.000	3.000	3.600
50.00	0.630	0.800	1.000	1.400	2.200	3.200	3.600
> 50.00	0.800	1.000	1.250	1.600	2.200	3.200	3.600

Coolant:

- Air
- Neat oil
- Soluble oil

Cutting direction:

- right-hand cutting
- left-hand cutting

Material group	Material examples, new description (old description in brackets) Figures in bold = material no. to DIN EN	Tensile str. MPa (N/mm <sup>2</sup> )	Hard- ness	Coolant
Common structural steels	<b>1.0035</b> S185(St33), <b>1.0486</b> P275N(StE285), <b>1.0345</b> P235GH(H1), <b>1.0425</b> P265GH(H2) <b>1.0050</b> E295 (St50-2), <b>1.0070</b> E360 (St70-2), <b>1.8937</b> P500NH (WStE500)	≤500 ≤1000		
Free-cutting steels	<b>1.0718</b> 11SMnPb30 (9SMnPb28), <b>1.0736</b> 11SMn37 (9SMn36) <b>1.0727</b> 46S20 (45S20), <b>1.0728</b> (60S20), <b>1.0757</b> 46SPb20 (45SPb20)	≤850 ≤1000		
Unalloyed heat-treatable steels	<b>1.0402</b> C22, <b>1.1178</b> C30E (Ck30) <b>1.0503</b> C45, <b>1.1191</b> C45E (Ck45) <b>1.0601</b> C60, <b>1.1221</b> C60E (Ck60)	≤700 ≤850 ≤1000		
Alloyed heat-treatable steels	<b>1.5131</b> 50MnSi4, <b>1.7003</b> 38Cr2, <b>1.7030</b> 28Cr4 <b>1.5710</b> 36NiCr6, <b>1.7035</b> 41Cr4, <b>1.7225</b> 42CrMo4	≤1000 ≤1400		
Unalloyed case hard. steels	<b>1.0301</b> (C10), <b>1.1121</b> C10E (Ck10)	≤850		
Alloyed case hardened steels	<b>1.7276</b> 10CrMo11, <b>1.5125</b> 11MnSi6 <b>1.5752</b> 15NiCr13, <b>1.7131</b> 16MnCr5, <b>1.7264</b> 20CrMo5	≤1000 ≤1400		
Nitriding steels	<b>1.8504</b> 34CrAl6 <b>1.8519</b> 31CrMoV9, <b>1.8550</b> 34CrAlNi7	≤1000 ≤1400		
Tool steels	<b>1.1750</b> C75W, <b>1.2067</b> 102Cr6, <b>1.2307</b> 29CrMoV9 <b>1.2080</b> X210Cr12, <b>1.2083</b> X42Cr13, <b>1.2419</b> 105WCr6, <b>1.2767</b> X45NiCrMo4	≤850 ≤1400		
High speed steels	<b>1.3243</b> S 6-5-2-5, <b>1.3343</b> S 6-5-2, <b>1.3344</b> S 6-5-3	≤1400		
Spring steels	<b>1.5026</b> 55Si7, <b>1.7176</b> 55Cr3, <b>1.8159</b> 51CrV4 (51CrV4)		≤350 HB	
Stainless steels, sulphured	<b>1.4005</b> X12CrS13, <b>1.4104</b> X14CrMoS17, <b>1.4105</b> X6CrMoS17, <b>1.4305</b> X8CrNiS18-9	≤900		
austenitic	<b>1.4301</b> X5CrNi18-10 (V2A), <b>1.4541</b> X6CrNiTi18-10, <b>1.4571</b> X6CrNiMoTi 17-12-2 (V4A)	≤1100		
martensitic	<b>1.4057</b> X20CrNi172 (X17CrNi16-2), <b>1.4122</b> X39CrMo17-1, <b>1.4521</b> X2CrMoTi18-2	≤1500		
Hardened steels	-		≤48 HRC ≤66 HRC	
Special alloys	Nimonic, Inconel, Monel, Hastelloy	≤2000		
Cast iron	<b>0.6010</b> EN-GJL-100 (GG10), <b>0.6020</b> EN-GJL-200 (GG20) <b>0.6025</b> EN-GJL-250 (GG25), <b>0.6035</b> EN-GJL-350 (GG35)		≤240 HB ≤350 HB	
Spheroidal graphite iron and malleable cast iron	<b>0.7040</b> EN-GJS-400-15 (GGG40), <b>0.7050</b> EN-GJS-500-7 (GGG50), <b>0.8035</b> EN-GJMW-350-4 (GTW35) <b>0.7060</b> EN-GJS-600-3 (GGG60), <b>0.7070</b> EN-GJS-700-2 (GGG70), <b>0.8170</b> EN-GJMB-700-2 (GTS70)		≤240 HB ≤350 HB	
Chilled cast iron	-		≤350 HB	
Ti and Ti-alloys	<b>3.7024</b> Ti99.5, <b>3.7114</b> TiAl5Sn2.5, <b>3.7124</b> TiCu2 <b>3.7154</b> TiAl6Zr5, <b>3.7165</b> TiAl6V4, <b>3.7184</b> TiAl4Mo4Sn2.5, - TiAl8Mo1V1	≤850 ≤1400		
Aluminium and Al-alloys	<b>3.0255</b> Al99.5, <b>3.2315</b> AlMgSi1, <b>3.3515</b> AlMg1	≤400		
Al wrought alloys	<b>3.0615</b> AlMgSiPb, <b>3.1325</b> AlCuMg1, <b>3.3245</b> AlMg3Si, <b>3.4365</b> AlZnMgCu1.5	≤650		
Al cast alloys ≤ 10 % Si	<b>3.2131</b> G-AlSi5Cu1, <b>3.2153</b> G-AlSi7Cu3, <b>3.2573</b> G-AlSi9	≤600		
≤ 24 % Si	<b>3.2581</b> G-AlSi12, <b>3.2583</b> G-AlSi12Cu, - G-AlSi12CuNiMg	≤600		
Magnesium alloys	<b>3.5200</b> MgMn2, <b>3.5812.05</b> G-MgAl8Zn1, <b>3.5612.05</b> G-MgAl6Zn1	≤400		
Copper, low-alloyed	<b>2.0070</b> SE-Cu, <b>2.1020</b> CuSn6, <b>2.1096</b> G-CuSn5ZnPb	≤500		
Brass, short-chipping	<b>2.0380</b> CuZn39Pb2, <b>2.0401</b> CuZn39Pb3, <b>2.0410</b> CuZn43Pb2	≤600		
long-chipping	<b>2.0250</b> CuZn20, <b>2.0280</b> CuZn33, <b>2.0332</b> CuZn37Pb0.5	≤600		
Bronze, short-chipping	<b>2.1090</b> CuSn7ZnPb, <b>2.1170</b> CuPb5Sn5, <b>2.1176</b> CuPb10Sn <b>2.0790</b> CuNi18Zn19Pb	≤600 ≤850		
Bronze, long-chipping	<b>2.0916</b> CuAl5, <b>2.0960</b> CuAl9Mn, <b>2.1050</b> CuSn10 <b>2.0980</b> CuAl11Ni, <b>2.1247</b> CuBe2	≤850 ≤1000		
Duroplastics	Bakelit, Resopal, Pertinax, Moltopren	≤150		
Thermoplastics	Plexiglass, Hostalen, Novodur, Makralon	≤100		
New cast materials CGI	<b>EN-GJV250</b> (GGV25), <b>EN-GJV350</b> (GGV35) <b>EN-GJV400</b> (GGV40), <b>EN-GJV500</b> (GGV50), SiMo 6		≤220 HB ≤300 HB	
New cast materials ADI	<b>EN-GJS-800-8</b> (ADI800), <b>EN-GJS-1000-5</b> (ADI1000) <b>EN-GJS-1200-2</b> (ADI1200), <b>EN-GJS-1400-1</b> (ADI1400)	≤1000 ≤1400		
Kevlar	Kevlar	≤1000		
Glass, carbon conc. plastics	GRP/CFRP	≤1000		

- bright
- steam tempered
- nitrided
- TiAlN
- TiAlN nanoA
- Carbo
- TiN

# Reamers

1038	1039
G.S.	G.S.
Carbide	
HR500 GT S	HR500 GT D

1040	1041
G.S.	G.S.
Cermet	
HR500 GT S	HR500 GT D

NC reamers

1427	1449
5527	
G.S.	G.S.
Solid carbide	
B	B

# Machine reamers

1408	1409	1410	1411	717	718	719	720
~8093	~8093	~8094	~8094	~8050	~8050	~8051	~8051
Carbide		Carbide		Carbide		Carbide	
A	B	A	B	A	B	A	B



Vc m/min	Feed column no.	
25-40	74-75	74-75
25-40	74-75	74-75
25-40	74-75	74-75
25-40	74-75	74-75
25-40	74-75	74-75
25-40	74-75	74-75
25-40	74-75	74-75
25-40	74	74
25-40	74-75	74-75
25-40	74-75	74-75
25-40	74	74
25-40	74-75	74-75
25-40	74	74
25-40	74-75	74-75
25-40	74	74
25-40	74-75	74-75
25-40	74	74
25-40	74-75	74-75
25-40	74	74
20-30	74	74
20-30	74-75	74-75
30-60	74-75	74-75
20-30	74-75	74-75
20-30	74-75	74-75
10-20	72-73	72-73
20-30	73-74	73-74
40-100	75-76	75-76
40-100	75-76	75-76
50-120	75-76	75-76
50-100	75-76	75-76
20-40	74-75	74-75
20-40	73-74	73-74
20-40	73-74	73-74
80-160	75-76	75-76
40-120	74-75	74-75
50-120	74-75	74-75
50-120	74-75	74-75
40-120	74-75	74-75
40-120	74-75	74-75
60-80	74-75	74-75
40-80	74-75	74-75
40-120	71	71
40-120	71	71

Vc m/min	Feed column no.	
100-180	75-76	75-76
100-180	75-76	75-76
100-180	75-76	75-76
100-180	75-76	75-76
100-180	75-76	75-76
100-180	75-76	75-76
100-180	75-76	75-76
80-120	74	74
100-180	75-76	75-76
100-180	75-76	75-76
100-180	75-76	75-76
80-120	74	74
100-180	75-76	75-76
100-180	75-76	75-76
80-120	74	74
100-180	75-76	75-76
80-120	74	74
100-120	74-75	74-75
120-300	72-75	72-75

Vc m/min	Feed column no.	
18	72	72
16	72	72
18	72	72
16	72	72
18	71	71
16	72	72
14	71	71
14	71	71
12	71	71
18	71	71
14	71	71
12	71	71
14	71	71
12	71	71
12	71	71
10	71	71
10	71	71
8	71	71
6	71	71
6	71	71
6	71	71
6	71	71
20	71	71
18	71	71
20	71	71
18	71	71
10	71	71
10	71	71
30	73	73
30	73	73
40	72	72
30	72	72
25	72	72
25	72	72
35	72	72
30	72	72
35	72	72
30	72	72
30	72	72
25	72	72
20	73	73
20	73	73
16	71	71
16	71	71
12	71	71
12	71	71

Vc m/min	Feed column no.							
18	72	72	72	72	72	72	72	72
16	72	72	72	72	72	72	72	72
18	72	72	72	72	72	72	72	72
16	72	72	72	72	72	72	72	72
18	71	71	71	71	71	71	71	71
16	72	72	72	72	72	72	72	72
14	71	71	71	71	71	71	71	71
14	71	71	71	71	71	71	71	71
12	71	71	71	71	71	71	71	71
18	71	71	71	71	71	71	71	71
14	71	71	71	71	71	71	71	71
12	71	71	71	71	71	71	71	71
14	71	71	71	71	71	71	71	71
12	71	71	71	71	71	71	71	71
10	71	71	71	71	71	71	71	71
10	71	71	71	71	71	71	71	71
8	71	71	71	71	71	71	71	71
6	71	71	71	71	71	71	71	71
6	71	71	71	71	71	71	71	71
6	71	71	71	71	71	71	71	71
6	71	71	71	71	71	71	71	71
20	71	71	71	71	71	71	71	71
18	71	71	71	71	71	71	71	71
20	71	71	71	71	71	71	71	71
18	71	71	71	71	71	71	71	71
10	71	71	71	71	71	71	71	71
10	71	71	71	71	71	71	71	71
30	73	73	73	73	73	73	73	73
30	73	73	73	73	73	73	73	73
40	72	72	72	72	72	72	72	72
30	72	72	72	72	72	72	72	72
25	72	72	72	72	72	72	72	72
25	72	72	72	72	72	72	72	72
35	72	72	72	72	72	72	72	72
30	72	72	72	72	72	72	72	72
35	72	72	72	72	72	72	72	72
30	72	72	72	72	72	72	72	72
30	72	72	72	72	72	72	72	72
25	72	72	72	72	72	72	72	72
20	73	73	73	73	73	73	73	73
20	73	73	73	73	73	73	73	73
16	71	71	71	71	71	71	71	71
16	71	71	71	71	71	71	71	71
12	71	71	71	71	71	71	71	71
12	71	71	71	71	71	71	71	71



bright  
 steam tempered  
 nitrided  
 TiAlN  
 TiAlN nanoA  
 Carbo  
 TiN

Technical section

Tools with bold feed column no. are preferred choice.



For blind holes with close diameter tolerances choose straight-fluted reamers.

To select the optimal tool and the recommended machining parameters for your application, please also use the electronic version of the GuhringNavigator on the internet: [www.guehring.de](http://www.guehring.de).



- Guhring no.** 
- Guhring no.** 
- Standard/DIN**
- Tool material**
- Surface finish**
- Form**
- Cooling**































Counter-sink Ø mm	Feed column no.						
	71	72	73	74	75	76	77
	f (mm/rev.)						
< 4.00	0.080	0.100	0.125	0.300	0.500	0.800	1.000
4.00	0.100	0.125	0.160	0.300	0.500	1.000	1.200
5.00	0.100	0.125	0.160	0.400	0.600	1.000	1.400
6.30	0.125	0.160	0.200	0.400	0.700	1.200	1.600
8.00	0.160	0.200	0.250	0.600	1.000	1.800	2.400
10.00	0.200	0.250	0.315	0.600	1.200	1.800	2.400
12.50	0.200	0.250	0.315	0.800	1.200	2.000	2.500
16.00	0.250	0.315	0.400	0.800	1.400	2.200	2.600
20.00	0.315	0.400	0.500	0.800	1.400	2.200	2.600
25.00	0.400	0.500	0.630	1.000	1.600	2.500	3.000
31.50	0.400	0.500	0.630	1.000	2.000	3.000	3.600
40.00	0.500	0.630	0.800	1.200	2.000	3.000	3.600
50.00	0.630	0.800	1.000	1.400	2.200	3.200	3.600
> 50.00	0.800	1.000	1.250	1.600	2.200	3.200	3.600

Coolant:

-  Air
-  Neat oil
-  Soluble oil

Cutting direction:

-  right-hand cutting
-  left-hand cutting

Material group	Material examples, new description (old description in brackets) Figures in bold = material no. to DIN EN	Tensile str. MPa (N/mm²)	Hard- ness	Coolant
Common structural steels	<b>1.0035</b> S185(St33), <b>1.0486</b> P275N(StE285), <b>1.0345</b> P235GH(H1), <b>1.0425</b> P265GH(H2) <b>1.0050</b> E295 (St50-2), <b>1.0070</b> E360 (St70-2), <b>1.8937</b> P500NH (WStE500)	≤500 ≤1000		 
Free-cutting steels	<b>1.0718</b> 11SMnPb30 (9SMnPb28), <b>1.0736</b> 11SMn37 (9SMn36) <b>1.0727</b> 46S20 (45S20), <b>1.0728</b> (60S20), <b>1.0757</b> 46SPb20 (45SPb20)	≤850 ≤1000		 
Unalloyed heat-treatable steels	<b>1.0402</b> C22, <b>1.1178</b> C30E (Ck30) <b>1.0503</b> C45, <b>1.1191</b> C45E (Ck45) <b>1.0601</b> C60, <b>1.1221</b> C60E (Ck60)	≤700 ≤850 ≤1000		  
Alloyed heat-treatable steels	<b>1.5131</b> 50MnSi4, <b>1.7003</b> 38Cr2, <b>1.7030</b> 28Cr4 <b>1.5710</b> 36NiCr6, <b>1.7035</b> 41Cr4, <b>1.7225</b> 42CrMo4	≤1000 ≤1400		 
Unalloyed case hard. steels	<b>1.0301</b> (C10), <b>1.1121</b> C10E (Ck10)	≤850		
Alloyed case hardened steels	<b>1.7276</b> 10CrMo11, <b>1.5125</b> 11MnSi6 <b>1.5752</b> 15NiCr13, <b>1.7131</b> 16MnCr5, <b>1.7264</b> 20CrMo5	≤1000 ≤1400		 
Nitriding steels	<b>1.8504</b> 34CrAl6 <b>1.8519</b> 31CrMoV9, <b>1.8550</b> 34CrAlNi7	≤1000 ≤1400		 
Tool steels	<b>1.1750</b> C75W, <b>1.2067</b> 102Cr6, <b>1.2307</b> 29CrMoV9 <b>1.2080</b> X210Cr12, <b>1.2083</b> X42Cr13, <b>1.2419</b> 105WCr6, <b>1.2767</b> X45NiCrMo4	≤850 ≤1400		 
High speed steels	<b>1.3243</b> S 6-5-2-5, <b>1.3343</b> S 6-5-2, <b>1.3344</b> S 6-5-3	≤1400		
Spring steels	<b>1.5026</b> 55Si7, <b>1.7176</b> 55Cr3, <b>1.8159</b> 51CrV4 (51CrV4)		≤350 HB	
Stainless steels, sulphured	<b>1.4005</b> X12CrS13, <b>1.4104</b> X14CrMoS17, <b>1.4105</b> X6CrMoS17, <b>1.4305</b> X8CrNiS18-9	≤900		
austenitic	<b>1.4301</b> X5CrNi18-10 (V2A), <b>1.4541</b> X6CrNiTi18-10, <b>1.4571</b> X6CrNiMoTi 17-12-2 (V4A)	≤1100		
martensitic	<b>1.4057</b> X20CrNi172 (X17CrNi16-2), <b>1.4122</b> X39CrMo17-1, <b>1.4521</b> X2CrMoTi18-2	≤1500		
Hardened steels	-		≤48 HRC ≤66 HRC	 
Special alloys	Nimonic, Inconel, Monel, Hastelloy	≤2000		
Cast iron	<b>0.6010</b> EN-GJL-100 (GG10), <b>0.6020</b> EN-GJL-200 (GG20) <b>0.6025</b> EN-GJL-250 (GG25), <b>0.6035</b> EN-GJL-350 (GG35)		≤240 HB ≤350 HB	 
Spheroidal graphite iron and malleable cast iron	<b>0.7040</b> EN-GJS-400-15 (GGG40), <b>0.7050</b> EN-GJS-500-7 (GGG50), <b>0.8035</b> EN-GJMW-350-4 (GTW35) <b>0.7060</b> EN-GJS-600-3 (GGG60), <b>0.7070</b> EN-GJS-700-2 (GGG70), <b>0.8170</b> EN-GJMB-700-2 (GTS70)		≤240 HB ≤350 HB	 
Chilled cast iron	-		≤350 HB	
Ti and Ti-alloys	<b>3.7024</b> Ti99.5, <b>3.7114</b> TiAl5Sn2.5, <b>3.7124</b> TiCu2 <b>3.7154</b> TiAl6Zr5, <b>3.7165</b> TiAl6V4, <b>3.7184</b> TiAl4Mo4Sn2.5, - TiAl8Mo1V1	≤850 ≤1400		 
Aluminium and Al-alloys	<b>3.0255</b> Al99.5, <b>3.2315</b> AlMgSi1, <b>3.3515</b> AlMg1	≤400		
Al wrought alloys	<b>3.0615</b> AlMgSiPb, <b>3.1325</b> AlCuMg1, <b>3.3245</b> AlMg3Si, <b>3.4365</b> AlZnMgCu1.5	≤650		
Al cast alloys ≤ 10 % Si	<b>3.2131</b> G-AlSi5Cu1, <b>3.2153</b> G-AlSi7Cu3, <b>3.2573</b> G-AlSi9	≤600		
≤ 24 % Si	<b>3.2581</b> G-AlSi12, <b>3.2583</b> G-AlSi12Cu, - G-AlSi12CuNiMg	≤600		
Magnesium alloys	<b>3.5200</b> MgMn2, <b>3.5812.05</b> G-MgAl8Zn1, <b>3.5612.05</b> G-MgAl6Zn1	≤400		
Copper, low-alloyed	<b>2.0070</b> SE-Cu, <b>2.1020</b> CuSn6, <b>2.1096</b> G-CuSn5ZnPb	≤500		
Brass, short-chipping	<b>2.0380</b> CuZn39Pb2, <b>2.0401</b> CuZn39Pb3, <b>2.0410</b> CuZn43Pb2	≤600		
long-chipping	<b>2.0250</b> CuZn20, <b>2.0280</b> CuZn33, <b>2.0332</b> CuZn37Pb0.5	≤600		
Bronze, short-chipping	<b>2.1090</b> CuSn7ZnPb, <b>2.1170</b> CuPb5Sn5, <b>2.1176</b> CuPb10Sn <b>2.0790</b> CuNi18Zn19Pb	≤600 ≤850		 
Bronze, long-chipping	<b>2.0916</b> CuAl5, <b>2.0960</b> CuAl9Mn, <b>2.1050</b> CuSn10 <b>2.0980</b> CuAl11Ni, <b>2.1247</b> CuBe2	≤850 ≤1000		 
Duroplastics	Bakelit, Resopal, Pertinax, Moltopren	≤150		
Thermoplastics	Plexiglass, Hostalen, Novodur, Makralon	≤100		
New cast materials CGI	<b>EN-GJV250</b> (GGV25), <b>EN-GJV350</b> (GGV35) <b>EN-GJV400</b> (GGV40), <b>EN-GJV500</b> (GGV50), SiMo 6		≤220 HB ≤300 HB	 
New cast materials ADI	<b>EN-GJS-800-8</b> (ADI800), <b>EN-GJS-1000-5</b> (ADI1000) <b>EN-GJS-1200-2</b> (ADI1200), <b>EN-GJS-1400-1</b> (ADI1400)	≤1000 ≤1400		 
Kevlar	Kevlar	≤1000		
Glass, carbon conc. plastics	GRP/CFRP	≤1000		

-  bright
-  steam tempered
-  nitrided
-  TiAIN
-  TiAIN nanoA
-  Carbo
-  TiN

# Reamers

Machine reamers

1428	1429
~8093	~8093
Carbide	
A	B

Expand. reamers

749	740
G.S.	G.S.
Carbide	
A	A

stepped

743
G.S.
Carbide

## Machine reamers

674	1407	737
~8090	~8090	~8090
Carbide	Carbide	Carbide
A	B	C

1430
~8090
Carbide
A

727
8054
Carbide



V <sub>c</sub> m/min	Feed column no.		V <sub>c</sub> m/min	Feed column no.		V <sub>c</sub> m/min	Feed col. no.	V <sub>c</sub> m/min	Feed column no.			V <sub>c</sub> m/min	Feed col. no.	V <sub>c</sub> m/min	Feed col. no.
20	73	73	16	71	71	18	72	20	72	72	72	22	72	20	72
18	73	73	14	71	71	16	72	18	72	72	72	20	72	20	72
20	73	73	14	71	71	18	72	20	72	72	72	22	72	20	72
18	73	73	12	71	71	16	72	18	72	72	72	20	72	20	72
20	72	72	14	71	71	18	71	20	71	71	71	22	71	20	71
18	72	72	12	71	71	16	72	18	71	71	71	20	71	20	71
15	72	72	12	71	71	14	71	16	71	71	71	18	71	16	71
15	72	72	12	71	71	14	71	16	71	71	71	18	71	18	71
13	71	71	10	71	71	12	71	14	71	71	71	13	71	14	71
20	73	73	14	71	71	18	71	20	71	71	71	22	71	20	72
15	72	72	12	71	71	14	71	16	71	71	71	18	71	18	71
13	72	72	10	71	71	12	71	14	71	71	71	15	71	14	71
15	71	71	12	71	71	14	71	16	71	71	71	18	71	18	71
13	71	71	10	71	71	12	71	14	71	71	71	15	71	14	71
13	71	71	10	71	71	12	71	14	71	71	71	15	71	18	71
11	71	71	10	71	71	10	71	12	71	71	71	13	71	12	71
11	71	71	8	71	71	10	71	12	71	71	71	13	71	14	71
11	71	71	8	71	71	10	71	12	71	71	71	13	71	8	71
9	71	71	8	71	71			8	71	71	71	9	71	14	71
7	71	71	6	71	71			6	71	71	71	7	71	12	71
7	71	71	6	71	71			6	71	71	71	7	71	10	71
7	71	71	6	71	71	6	71	6	71	71	71	7	71	8	71
22	73	73	20	71	71	20	71	20	71	71	71	22	71	22	71
20	73	73	18	71	71	18	71	18	71	71	71	20	71	18	71
22	73	73	20	71	71	20	71	20	71	71	71	22	71	20	71
20	73	73	20	71	71	18	71	20	71	71	71	22	71	18	71
4	71	71	4	71	71										
11	71	71	8	71	71	10	71	10	71	71	71	11	71	10	71
11	71	71	8	71	71	10	71	10	71	71	71	11	71	10	71
			25	72	72	30	73	30	73	73	73			30	73
			25	72	72	30	73	30	73	73	73			30	73
			35	72	72	40	72	40	72	72	72			35	73
			30	72	72	30	72	30	72	72	72			25	73
28	73	73	20	72	72	25	72	25	72	72	72	28	72	25	73
28	73	73	20	72	72	25	72	35	72	72	72	39	72	25	73
39	73	73	30	72	72	35	72	35	72	72	72	33	72	35	73
33	73	73	25	72	72	30	72	30	72	72	72	33	72	30	73
39	73	73	30	72	72	35	72	30	72	72	72	33	72	30	73
33	73	73	25	72	72	30	72	25	72	72	72	28	72	25	73
33	73	73	25	72	72	30	72	30	72	72	72	33	72	30	73
28	73	73	20	72	72	25	72	25	72	72	72	28	72	25	73
22	73	73	16	73	73	20	73	12	73	73	73	12	73	20	72
22	73	73	16	73	73	20	73	14	73	73	73	14	73	20	73
16	71	71	16	71	71			16	71	71	71				
16	71	71	16	71	71			16	71	71	71				

bright    steam tempered    nitrided    TiAlN    TiAlN nanoA    Carbo    TiN

Tools with bold feed column no. are preferred choice.

For blind holes with close diameter tolerances choose straight-fluted reamers.

To select the optimal tool and the recommended machining parameters for your application, please also use the electronic version of the GuhringNavigator on the internet: [www.guehring.de](http://www.guehring.de).

- Guhring no.**
- Guhring no.**
- Standard/DIN**
- Tool material**
- Surface finish**
- Form**
- Cooling**

Counter-sink Ø mm	Feed column no.						
	71	72	73	74	75	76	77
	f (mm/rev.)						
< 4.00	0.080	0.100	0.125	0.300	0.500	0.800	1.000
4.00	0.100	0.125	0.160	0.300	0.500	1.000	1.200
5.00	0.100	0.125	0.160	0.400	0.600	1.000	1.400
6.30	0.125	0.160	0.200	0.400	0.700	1.200	1.600
8.00	0.160	0.200	0.250	0.600	1.000	1.800	2.400
10.00	0.200	0.250	0.315	0.600	1.200	1.800	2.400
12.50	0.200	0.250	0.315	0.800	1.200	2.000	2.500
16.00	0.250	0.315	0.400	0.800	1.400	2.200	2.600
20.00	0.315	0.400	0.500	0.800	1.400	2.200	2.600
25.00	0.400	0.500	0.630	1.000	1.600	2.500	3.000
31.50	0.400	0.500	0.630	1.000	2.000	3.000	3.600
40.00	0.500	0.630	0.800	1.200	2.000	3.000	3.600
50.00	0.630	0.800	1.000	1.400	2.200	3.200	3.600
> 50.00	0.800	1.000	1.250	1.600	2.200	3.200	3.600

- Coolant:
- Air
  - Neat oil
  - Soluble oil
- Cutting direction:
- right-hand cutting
  - left-hand cutting

Material group	Material examples, new description (old description in brackets) Figures in bold = material no. to DIN EN	Tensile str. MPa (N/mm²)	Hardness	Coolant
Common structural steels	<b>1.0035</b> S185(St33), <b>1.0486</b> P275N(StE285), <b>1.0345</b> P235GH(H1), <b>1.0425</b> P265GH(H2) <b>1.0050</b> E295 (St50-2), <b>1.0070</b> E360 (St70-2), <b>1.8937</b> P500NH (WStE500)	≤500 ≤1000		
Free-cutting steels	<b>1.0718</b> 11SMnPb30 (9SMnPb28), <b>1.0736</b> 11SMn37 (9SMn36) <b>1.0727</b> 46S20 (45S20), <b>1.0728</b> (60S20), <b>1.0757</b> 46SPb20 (45SPb20)	≤850 ≤1000		
Unalloyed heat-treatable steels	<b>1.0402</b> C22, <b>1.1178</b> C30E (Ck30) <b>1.0503</b> C45, <b>1.1191</b> C45E (Ck45) <b>1.0601</b> C60, <b>1.1221</b> C60E (Ck60)	≤700 ≤850 ≤1000		
Alloyed heat-treatable steels	<b>1.5131</b> 50MnSi4, <b>1.7003</b> 38Cr2, <b>1.7030</b> 28Cr4 <b>1.5710</b> 36NiCr6, <b>1.7035</b> 41Cr4, <b>1.7225</b> 42CrMo4	≤1000 ≤1400		
Unalloyed case hard. steels	<b>1.0301</b> (C10), <b>1.1121</b> C10E (Ck10)	≤850		
Alloyed case hardened steels	<b>1.7276</b> 10CrMo11, <b>1.5125</b> 11MnSi6 <b>1.5752</b> 15NiCr13, <b>1.7131</b> 16MnCr5, <b>1.7264</b> 20CrMo5	≤1000 ≤1400		
Nitriding steels	<b>1.8504</b> 34CrAl6 <b>1.8519</b> 31CrMoV9, <b>1.8550</b> 34CrAlNi7	≤1000 ≤1400		
Tool steels	<b>1.1750</b> C75W, <b>1.2067</b> 102Cr6, <b>1.2307</b> 29CrMoV9 <b>1.2080</b> X210Cr12, <b>1.2083</b> X42Cr13, <b>1.2419</b> 105WCr6, <b>1.2767</b> X45NiCrMo4	≤850 ≤1400		
High speed steels	<b>1.3243</b> S 6-5-2-5, <b>1.3343</b> S 6-5-2, <b>1.3344</b> S 6-5-3	≤1400		
Spring steels	<b>1.5026</b> 55Si7, <b>1.7176</b> 55Cr3, <b>1.8159</b> 51CrV4 (51CrV4)		≤350 HB	
Stainless steels, sulphured	<b>1.4005</b> X12CrS13, <b>1.4104</b> X14CrMoS17, <b>1.4105</b> X6CrMoS17, <b>1.4305</b> X8CrNiS18-9	≤900		
austenitic	<b>1.4301</b> X5CrNi18-10 (V2A), <b>1.4541</b> X6CrNiTi18-10, <b>1.4571</b> X6CrNiMoTi 17-12-2 (V4A)	≤1100		
martensitic	<b>1.4057</b> X20CrNi172 (X17CrNi16-2), <b>1.4122</b> X39CrMo17-1, <b>1.4521</b> X2CrMoTi18-2	≤1500		
Hardened steels	-		≤48 HRC ≤66 HRC	
Special alloys	Nimonic, Inconel, Monel, Hastelloy	≤2000		
Cast iron	<b>0.6010</b> EN-GJL-100 (GG10), <b>0.6020</b> EN-GJL-200 (GG20) <b>0.6025</b> EN-GJL-250 (GG25), <b>0.6035</b> EN-GJL-350 (GG35)		≤240 HB ≤350 HB	
Spheroidal graphite iron and malleable cast iron	<b>0.7040</b> EN-GJS-400-15 (GGG40), <b>0.7050</b> EN-GJS-500-7 (GGG50), <b>0.8035</b> EN-GJMW-350-4 (GTW35) <b>0.7060</b> EN-GJS-600-3 (GGG60), <b>0.7070</b> EN-GJS-700-2 (GGG70), <b>0.8170</b> EN-GJMB-700-2 (GTS70)		≤240 HB ≤350 HB	
Chilled cast iron	-		≤350 HB	
Ti and Ti-alloys	<b>3.7024</b> Ti99.5, <b>3.7114</b> TiAl5Sn2.5, <b>3.7124</b> TiCu2 <b>3.7154</b> TiAl6Zr5, <b>3.7165</b> TiAl6V4, <b>3.7184</b> TiAl4Mo4Sn2.5, - TiAl8Mo1V1	≤850 ≤1400		
Aluminium and Al-alloys	<b>3.0255</b> Al99.5, <b>3.2315</b> AlMgSi1, <b>3.3515</b> AlMg1	≤400		
Al wrought alloys	<b>3.0615</b> AlMgSiPb, <b>3.1325</b> AlCuMg1, <b>3.3245</b> AlMg3Si, <b>3.4365</b> AlZnMgCu1.5	≤650		
Al cast alloys ≤ 10 % Si	<b>3.2131</b> G-AlSi5Cu1, <b>3.2153</b> G-AlSi7Cu3, <b>3.2573</b> G-AlSi9	≤600		
≤ 24 % Si	<b>3.2581</b> G-AlSi12, <b>3.2583</b> G-AlSi12Cu, - G-AlSi12CuNiMg	≤600		
Magnesium alloys	<b>3.5200</b> MgMn2, <b>3.5812.05</b> G-MgAl8Zn1, <b>3.5612.05</b> G-MgAl6Zn1	≤400		
Copper, low-alloyed	<b>2.0070</b> SE-Cu, <b>2.1020</b> CuSn6, <b>2.1096</b> G-CuSn5ZnPb	≤500		
Brass, short-chipping	<b>2.0380</b> CuZn39Pb2, <b>2.0401</b> CuZn39Pb3, <b>2.0410</b> CuZn43Pb2	≤600		
long-chipping	<b>2.0250</b> CuZn20, <b>2.0280</b> CuZn33, <b>2.0332</b> CuZn37Pb0.5	≤600		
Bronze, short-chipping	<b>2.1090</b> CuSn7ZnPb, <b>2.1170</b> CuPb5Sn5, <b>2.1176</b> CuPb10Sn <b>2.0790</b> CuNi18Zn19Pb	≤600 ≤850		
Bronze, long-chipping	<b>2.0916</b> CuAl5, <b>2.0960</b> CuAl9Mn, <b>2.1050</b> CuSn10 <b>2.0980</b> CuAl11Ni, <b>2.1247</b> CuBe2	≤850 ≤1000		
Duroplastics	Bakelit, Resopal, Pertinax, Moltopren	≤150		
Thermoplastics	Plexiglass, Hostalen, Novodur, Makralon	≤100		
New cast materials CGI	<b>EN-GJV250</b> (GGV25), <b>EN-GJV350</b> (GGV35) <b>EN-GJV400</b> (GGV40), <b>EN-GJV500</b> (GGV50), SiMo 6		≤220 HB ≤300 HB	
New cast materials ADI	<b>EN-GJS-800-8</b> (ADI800), <b>EN-GJS-1000-5</b> (ADI1000) <b>EN-GJS-1200-2</b> (ADI1200), <b>EN-GJS-1400-1</b> (ADI1400)	≤1000 ≤1400		
Kevlar	Kevlar	≤1000		
Glass, carbon conc. plastics	GRP/CFRP	≤1000		

- bright
- steam tempered
- nitrided
- TiAlN
- TiAlN nanoA
- Carbo
- TiN



# Reamers

## NC reamers

## Machine reamers

## Quick spiral reamers

455	490
212-3	212-3
HSS-E	HSS-E
B	B

401	402	440	1431	496	468	404	405
457	467						
212	212	212-2	212-2	212	212-2	208	208
HSS-E	HSS-E	HSS-E	HSS-E	HSS-E	HSS-E	HSS-E	HSS-E
A	B	A	A	B	B	A	B

641	642
212-2	208
HSS-E	HSS-E
B	B

469	403	406
212-2	212-1	208
HSS-E		
C	C	C

axial



V <sub>c</sub> m/min	Feed column no.	
16	72	72
12	72	72
12	72	72
10	71	71
14	72	72
12	71	71
10	71	71
10	71	71
8	71	71
16	72	72
10	71	71
8	71	71
10	71	71
8	71	71
14	72	72
10	71	71
10	71	71
6	72	72
6	72	72
4	72	72
4	71	71
14	71	71
12	71	71
12	71	71
10	71	71
6	71	71
4	71	71
18	73	73
18	73	73
20	72	72
18	72	72
20	72	72
18	72	72
18	72	72
16	72	72
20	72	72
18	72	72
18	72	72
14	72	72
12	73	73
14	73	73
8	71	71
8	71	71

V <sub>c</sub> m/min	Feed column no.							
16	72	72	72	72	72	72	72	72
12	72	72	72	72	72	72	72	72
12	72	72	72	72	72	72	72	72
10	71	71	71	71	71	71	71	71
14	72	72	72	72	72	72	72	72
12	71	71	71	71	71	71	71	71
10	71	71	71	71	71	71	71	71
10	71	71	71	71	71	71	71	71
8	71	71	71	71	71	71	71	71
16	72	72	72	72	72	72	72	72
10	71	71	71	71	71	71	71	71
8	71	71	71	71	71	71	71	71
10	71	71	71	71	71	71	71	71
8	71	71	71	71	71	71	71	71
8	71	71	71	71	71	71	71	71
14	72	72	72	72	72	72	72	72
10	71	71	71	71	71	71	71	71
10	71	71	71	71	71	71	71	71
6	72	72	72	72	72	72	72	72
6	72	72	72	72	72	72	72	72
4	72	72	72	72	72	72	72	72
4	71	71	71	71	71	71	71	71
14	71	71	71	71	71	71	71	71
12	71	71	71	71	71	71	71	71
12	71	71	71	71	71	71	71	71
10	71	71	71	71	71	71	71	71
6	71	71	71	71	71	71	71	71
4	71	71	71	71	71	71	71	71
18	73	73	73	73	73	73	73	73
18	73	73	73	73	73	73	73	73
20	72	72	72	72	72	72	72	72
18	72	72	72	72	72	72	72	72
20	72	72	72	72	72	72	72	72
18	72	72	72	72	72	72	72	72
18	72	72	72	72	72	72	72	72
16	72	72	72	72	72	72	72	72
20	72	72	72	72	72	72	72	72
18	72	72	72	72	72	72	72	72
18	72	72	72	72	72	72	72	72
14	72	72	72	72	72	72	72	72
12	73	73	73	73	73	73	73	73
14	73	73	73	73	73	73	73	73
8	71	71	71	71	71	71	71	71
8	71	71	71	71	71	71	71	71

V <sub>c</sub> m/min	Feed column no.	
20	71	71
16	71	71
16	71	71
12	71	71
18	71	71
16	71	71
12	71	71
12	71	71
10	71	71
18	71	71
12	71	71
10	71	71
12	71	71
10	71	71
12	71	71
10	71	71
8	71	71
8	71	71
6	71	71
6	71	71
14	71	71
14	71	71
16	71	71
14	71	71
6	71	71
4	71	71
22	73	73
22	73	73
22	72	72
22	72	72
22	72	72
22	72	72
20	72	72
22	72	72
18	72	72
22	72	72
20	72	72
12	73	73
14	73	73
10	71	71
10	71	71

V <sub>c</sub> m/min	Feed column no.		
16	73	73	73
12	73	73	73
12	73	73	73
14	73	73	73
12	73	73	73
16	73	73	73
10	73	73	73
5	71	71	71
22	73	73	73
22	73	73	73
20	73	73	73
16	73	73	73
18	73	73	73
12	73	73	73
14	73	73	73

bright

steam tempered

nitrided

TiAlN

TiAlN nanoA

Carbo

S TiN

Tools with bold feed column no. are preferred choice.

For blind holes with close diameter tolerances choose straight-fluted reamers.

To select the optimal tool and the recommended machining parameters for your application, please also use the electronic version of the GuhringNavigator on the internet: [www.guehring.de](http://www.guehring.de).

- Guhring no.**
- Guhring no.**
- Standard/DIN**
- Tool material**
- Surface finish**
- Form**
- Cooling**

Counter-sink Ø mm	Feed column no.						
	71	72	73	74	75	76	77
	f (mm/rev.)						
< 4.00	0.080	0.100	0.125	0.300	0.500	0.800	1.000
4.00	0.100	0.125	0.160	0.300	0.500	1.000	1.200
5.00	0.100	0.125	0.160	0.400	0.600	1.000	1.400
6.30	0.125	0.160	0.200	0.400	0.700	1.200	1.600
8.00	0.160	0.200	0.250	0.600	1.000	1.800	2.400
10.00	0.200	0.250	0.315	0.600	1.200	1.800	2.400
12.50	0.200	0.250	0.315	0.800	1.200	2.000	2.500
16.00	0.250	0.315	0.400	0.800	1.400	2.200	2.600
20.00	0.315	0.400	0.500	0.800	1.400	2.200	2.600
25.00	0.400	0.500	0.630	1.000	1.600	2.500	3.000
31.50	0.400	0.500	0.630	1.000	2.000	3.000	3.600
40.00	0.500	0.630	0.800	1.200	2.000	3.000	3.600
50.00	0.630	0.800	1.000	1.400	2.200	3.200	3.600
> 50.00	0.800	1.000	1.250	1.600	2.200	3.200	3.600

- Coolant:
- Air
  - Neat oil
  - Soluble oil
- Cutting direction:
- right-hand cutting
  - left-hand cutting

Material group	Material examples, new description (old description in brackets) Figures in bold = material no. to DIN EN	Tensile str. MPa (N/mm <sup>2</sup> )	Hard- ness	Coolant
Common structural steels	<b>1.0035</b> S185(St33), <b>1.0486</b> P275N(StE285), <b>1.0345</b> P235GH(H1), <b>1.0425</b> P265GH(H2) <b>1.0050</b> E295 (St50-2), <b>1.0070</b> E360 (St70-2), <b>1.8937</b> P500NH (WStE500)	≤500 ≤1000		
Free-cutting steels	<b>1.0718</b> 11SMnPb30 (9SMnPb28), <b>1.0736</b> 11SMn37 (9SMn36) <b>1.0727</b> 46S20 (45S20), <b>1.0728</b> (60S20), <b>1.0757</b> 46SPb20 (45SPb20)	≤850 ≤1000		
Unalloyed heat-treatable steels	<b>1.0402</b> C22, <b>1.1178</b> C30E (Ck30) <b>1.0503</b> C45, <b>1.1191</b> C45E (Ck45) <b>1.0601</b> C60, <b>1.1221</b> C60E (Ck60)	≤700 ≤850 ≤1000		
Alloyed heat-treatable steels	<b>1.5131</b> 50MnSi4, <b>1.7003</b> 38Cr2, <b>1.7030</b> 28Cr4 <b>1.5710</b> 36NiCr6, <b>1.7035</b> 41Cr4, <b>1.7225</b> 42CrMo4	≤1000 ≤1400		
Unalloyed case hard. steels	<b>1.0301</b> (C10), <b>1.1121</b> C10E (Ck10)	≤850		
Alloyed case hardened steels	<b>1.7276</b> 10CrMo11, <b>1.5125</b> 11MnSi6 <b>1.5752</b> 15NiCr13, <b>1.7131</b> 16MnCr5, <b>1.7264</b> 20CrMo5	≤1000 ≤1400		
Nitriding steels	<b>1.8504</b> 34CrAl6 <b>1.8519</b> 31CrMoV9, <b>1.8550</b> 34CrAlNi7	≤1000 ≤1400		
Tool steels	<b>1.1750</b> C75W, <b>1.2067</b> 102Cr6, <b>1.2307</b> 29CrMoV9 <b>1.2080</b> X210Cr12, <b>1.2083</b> X42Cr13, <b>1.2419</b> 105WCr6, <b>1.2767</b> X45NiCrMo4	≤850 ≤1400		
High speed steels	<b>1.3243</b> S 6-5-2-5, <b>1.3343</b> S 6-5-2, <b>1.3344</b> S 6-5-3	≤1400		
Spring steels	<b>1.5026</b> 55Si7, <b>1.7176</b> 55Cr3, <b>1.8159</b> 51CrV4 (51CrV4)		≤350 HB	
Stainless steels, sulphured	<b>1.4005</b> X12CrS13, <b>1.4104</b> X14CrMoS17, <b>1.4105</b> X6CrMoS17, <b>1.4305</b> X8CrNiS18-9	≤900		
austenitic	<b>1.4301</b> X5CrNi18-10 (V2A), <b>1.4541</b> X6CrNiTi18-10, <b>1.4571</b> X6CrNiMoTi 17-12-2 (V4A)	≤1100		
martensitic	<b>1.4057</b> X20CrNi172 (X17CrNi16-2), <b>1.4122</b> X39CrMo17-1, <b>1.4521</b> X2CrMoTi18-2	≤1500		
Hardened steels	-		≤48 HRC ≤66 HRC	
Special alloys	Nimonic, Inconel, Monel, Hastelloy	≤2000		
Cast iron	<b>0.6010</b> EN-GJL-100 (GG10), <b>0.6020</b> EN-GJL-200 (GG20) <b>0.6025</b> EN-GJL-250 (GG25), <b>0.6035</b> EN-GJL-350 (GG35)		≤240 HB ≤350 HB	
Spheroidal graphite iron and malleable cast iron	<b>0.7040</b> EN-GJS-400-15 (GGG40), <b>0.7050</b> EN-GJS-500-7 (GGG50), <b>0.8035</b> EN-GJMW-350-4 (GTW35) <b>0.7060</b> EN-GJS-600-3 (GGG60), <b>0.7070</b> EN-GJS-700-2 (GGG70), <b>0.8170</b> EN-GJMB-700-2 (GTS70)		≤240 HB ≤350 HB	
Chilled cast iron	-		≤350 HB	
Ti and Ti-alloys	<b>3.7024</b> Ti99.5, <b>3.7114</b> TiAl5Sn2.5, <b>3.7124</b> TiCu2 <b>3.7154</b> TiAl6Zr5, <b>3.7165</b> TiAl6V4, <b>3.7184</b> TiAl4Mo4Sn2.5, - TiAl8Mo1V1	≤850 ≤1400		
Aluminium and Al-alloys	<b>3.0255</b> Al99.5, <b>3.2315</b> AlMgSi1, <b>3.3515</b> AlMg1	≤400		
Al wrought alloys	<b>3.0615</b> AlMgSiPb, <b>3.1325</b> AlCuMg1, <b>3.3245</b> AlMg3Si, <b>3.4365</b> AlZnMgCu1.5	≤650		
Al cast alloys ≤ 10 % Si	<b>3.2131</b> G-AlSi5Cu1, <b>3.2153</b> G-AlSi7Cu3, <b>3.2573</b> G-AlSi9	≤600		
≤ 24 % Si	<b>3.2581</b> G-AlSi12, <b>3.2583</b> G-AlSi12Cu, - G-AlSi12CuNiMg	≤600		
Magnesium alloys	<b>3.5200</b> MgMn2, <b>3.5812.05</b> G-MgAl8Zn1, <b>3.5612.05</b> G-MgAl6Zn1	≤400		
Copper, low-alloyed	<b>2.0070</b> SE-Cu, <b>2.1020</b> CuSn6, <b>2.1096</b> G-CuSn5ZnPb	≤500		
Brass, short-chipping	<b>2.0380</b> CuZn39Pb2, <b>2.0401</b> CuZn39Pb3, <b>2.0410</b> CuZn43Pb2	≤600		
long-chipping	<b>2.0250</b> CuZn20, <b>2.0280</b> CuZn33, <b>2.0332</b> CuZn37Pb0.5	≤600		
Bronze, short-chipping	<b>2.1090</b> CuSn7ZnPb, <b>2.1170</b> CuPb5Sn5, <b>2.1176</b> CuPb10Sn <b>2.0790</b> CuNi18Zn19Pb	≤600 ≤850		
Bronze, long-chipping	<b>2.0916</b> CuAl5, <b>2.0960</b> CuAl9Mn, <b>2.1050</b> CuSn10 <b>2.0980</b> CuAl11Ni, <b>2.1247</b> CuBe2	≤850 ≤1000		
Duroplastics	Bakelit, Resopal, Pertinax, Moltopren	≤150		
Thermoplastics	Plexiglass, Hostalen, Novodur, Makralon	≤100		
New cast materials CGI	<b>EN-GJV250</b> (GGV25), <b>EN-GJV350</b> (GGV35) <b>EN-GJV400</b> (GGV40), <b>EN-GJV500</b> (GGV50), SiMo 6		≤220 HB ≤300 HB	
New cast materials ADI	<b>EN-GJS-800-8</b> (ADI800), <b>EN-GJS-1000-5</b> (ADI1000) <b>EN-GJS-1200-2</b> (ADI1200), <b>EN-GJS-1400-1</b> (ADI1400)	≤1000 ≤1400		
Kevlar	Kevlar	≤1000		
Glass, carbon conc. plastics	GRP/CFRP	≤1000		

- bright
- steam tempered
- nitrided
- TiAlN
- TiAlN nanoA
- Carbo
- TiN

# Reamers

Machine reamers

488	1432	489	497/458
8089	8089		
HSS-E	HSS-E		
○	○	○	○
A	A	B	B

axial

Bottoming reamers

419	420
G.S.	
HSS-E	
○	○
A	A

Shell reamers

407	408
219	
HSS-E	
●	●
A	B

Taper pin reamers

410	411
2179	2180
HSS-E	
○	○

Machine br. reamers

414
311
HSS
●

Expanding mach. reamers

430
G.S.
HSS-E
○
A

stepped reamers

431
G.S.
HSS-E
○



V <sub>c</sub> m/min	Feed column no.				V <sub>c</sub> m/min	Feed col. no.		V <sub>c</sub> m/min	Feed col. no.		V <sub>c</sub> m/min	Feed no.		V <sub>c</sub> m/min	Feed no.		V <sub>c</sub> m/min	Feed no.		V <sub>c</sub> m/min	Feed no.	
16	71	71	71	71	10	71	71	16	71-72	71	16	73	8	72	72	14	72	16	71	14	72	
12	71	71	71	71	8	71	71	14	71	71	14	73	8	72	72	12	72	12	71	12	72	
12	71	71	71	71	14	71	71	12	71	71	14	73	8	72	72	12	72	12	71	12	72	
10	71	71	71	71	12	71	71	10	71	71	10	73	8	71	71	10	72	10	71	10	72	
14	71	71	71	71	10	71	71	16	71	71	16		8	71	71	14	71	14	71	12	72	
12	71	71	71	71	10	71	71	14	71	71	14		8	71	71	12	71	12	71	12	72	
10	71	71	71	71	10	71	71	10	71	71	10		8	71	71	10	71	10	71	10	71	
10	71	71	71	71	10	71	71	10	71	71	10		8	71	71	10	71	10	71	10	71	
8	71	71	71	71	8	71	71	8	71	71	8		8	71	71	6	71	8	71	10	71	
16	71	71	71	71	12	71	71	16	71	71	16		8	71	71	12	72	16	72	14	72	
10	71	71	71	71	10	71	71	10	71	71	10		8	71	71	10	71	10	71	10	71	
8	71	71	71	71	8	71	71	8	71	71	8		6	71	71	6	71	8	71	10	71	
10	71	71	71	71	10	71	71	10	71	71	10		6	71	71	8	71	10	71	10	71	
8	71	71	71	71	8	71	71	8	71	71	8		6	71	71	8	71	8	71	10	71	
14	71	71	71	71	8	71	71	14	71	71	14		6	71	71	12	71	14	71	12	71	
10	71	71	71	71	8	71	71	10	71	71	10		6	71	71	8	71	10	71	10	71	
10	71	71	71	71	8	71	71	10	71	71	10		6	71	71	10	71	10	71	10	71	
6	71	71	71	71	6	71	71	6	71	71	6		6	71	71	5	71	6	71	8	71	
6	71	71	71	71	4	71	71	4	71	71	4		6	71	71	4	71	4	71	5	71	
4	71	71	71	71	4	71	71	4	71	71	4		6	71	71	4	71	4	71	5	71	
4	71	71	71	71																		
4	71	71	71	71	3	71	71	4	71	71	4					3	71	3	71	3	71	
14	71	71	71	71	12	71	71	14	71	71	14		8	71	71	12	71	14	71	14	71	
12	71	71	71	71	10	71	71	12	71	71	12		8	71	71	12	71	12	71	12	71	
12	71	71	71	71	12	71	71	12	71	71	12		8	71	71	12	71	12	71	14	71	
12	71	71	71	71	10	71	71	10	71	71	10		8	71	71	10	71	10	71	12	71	
6	71	71	71	71	4	71	71	6	71	71	6		6	71	71	4	71	4	71	5	71	
4	71	71	71	71	3	71	71	4	71	71	4		3	71	71	3	71	3	71	4	71	
18	73	73	73	73	20	72	72	18	72	72	20	73	8	73	73	18	72	18	72	18	73	
18	73	73	73	73	20	72	72	18	72	72	20	73	8	73	73	18	73	18	72	18	73	
20	72	72	72	72	20	71	71	20	72	72	20	73	8	73	73	20	71	20	71	22	73	
18	72	72	72	72	18	71	71	18	72	72	18	73	8	72	72	18	71	18	71	20	73	
20	72	72	72	72	14	71	71	20	72	72	20	73	8	73	73	18	73	20	71	20	73	
18	72	72	72	72	14	71	71	18	72	72	18	73	8	72	72	16	72	14	71	16	73	
18	72	72	72	72	18	71	71	18	72	72	18	73	8	72	72	18	71	18	71	18	73	
16	72	72	72	72	16	71	71	16	72	72	20	73	8	72	72	16	72	16	71	16	73	
20	72	72	72	72	16	71	71	20	72	72	20		8	72	72	20	71	16	71	16	73	
18	72	72	72	72	14	71	71	18	72	72	18		8	72	72	14	71	14	71	14	73	
18	72	72	72	72	16	71	71	18	72	72	18		8	72	72	16	71	16	71	16	73	
14	72	72	72	72	14	71	71	14	72	72	14		8	72	72	14	71	14	71	14	73	
12	73	73	73	73	12	73	73	12	72	72	12	73	8	72	72	12	73	12	73	12	73	
14	73	73	73	73	10	73	73	14	72	72	14	73	8	72	72	10	72	12	73	12	73	
8	71	71	71	71				8	71	71	8		6	71	71							
8	71	71	71	71				8	71	71	8		6	71	71							

○ bright   ● steam tempered   ● nitrided   ● A TiAlN   ● a TiAlN nanoA   ● Cb Carbo   ● S TiN

Technical section

Tools with bold feed column no. are preferred choice.

To select the optimal tool and the recommended machining parameters for your application, please also use the electronic version of the GuhringNavigator on the internet: [www.guehring.de](http://www.guehring.de).

<b>Guhring no.</b>
<b>Standard/DIN</b>
<b>Tool material</b>
<b>Surface finish</b>
<b>Angle of taper</b>
<b>Type/Form</b>

Counter-sink Ø mm	Feed column no.					
	81	82	83	84	85	86
	f (mm/rev.)					
<b>2.00</b>	0.03	0.04	0.06	0.08	0.10	0.13
<b>2.50</b>	0.03	0.05	0.07	0.10	0.13	0.16
<b>3.15</b>	0.03	0.05	0.08	0.11	0.15	0.20
<b>4.00</b>	0.04	0.06	0.09	0.13	0.17	0.22
<b>5.00</b>	0.04	0.07	0.10	0.14	0.18	0.23
<b>6.30</b>	0.04	0.07	0.12	0.15	0.19	0.24
<b>8.00</b>	0.05	0.08	0.13	0.16	0.20	0.25
<b>10.00</b>	0.06	0.09	0.14	0.17	0.22	0.26
<b>12.50</b>	0.06	0.10	0.15	0.19	0.23	0.28
<b>16.00</b>	0.07	0.11	0.17	0.21	0.26	0.31
<b>20.00</b>	0.08	0.13	0.18	0.23	0.28	0.33
<b>25.00</b>	0.09	0.15	0.21	0.26	0.30	0.38
<b>31.50</b>	0.12	0.17	0.24	0.30	0.36	0.42
<b>40.00</b>	0.14	0.21	0.28	0.34	0.40	0.46
<b>50.00</b>	0.17	0.24	0.31	0.36	0.42	0.48
<b>63.00</b>	0.20	0.27	0.33	0.38	0.44	0.50
<b>80.00</b>	0.23	0.30	0.35	0.40	0.46	0.52
<b>100.00</b>	0.25	0.30	0.35	0.40	0.46	0.52

- Coolant:
- Air
  - Neat oil
  - Soluble oil







Material group	Material examples, new description (old description in brackets) Figures in bold = material no. to DIN EN	Tensile str. MPa (N/mm <sup>2</sup> )	Hard- ness	Coolant
Common structural steels	<b>1.0035</b> S185(St33), <b>1.0486</b> P275N(StE285), <b>1.0345</b> P235GH(H1), <b>1.0425</b> P265GH(H2) <b>1.0050</b> E295 (St50-2), <b>1.0070</b> E360 (St70-2), <b>1.8937</b> P500NH (WStE500)	≤500 ≤1000		●
Free-cutting steels	<b>1.0718</b> 11SMnPb30 (9SMnPb28), <b>1.0736</b> 11SMn37 (9SMn36) <b>1.0727</b> 46S20 (45S20), <b>1.0728</b> (60S20), <b>1.0757</b> 46SPb20 (45SPb20)	≤850 ≤1000		●
Unalloyed heat-treatable steels	<b>1.0402</b> C22, <b>1.1178</b> C30E (Ck30) <b>1.0503</b> C45, <b>1.1191</b> C45E (Ck45) <b>1.0601</b> C60, <b>1.1221</b> C60E (Ck60)	≤700 ≤850 ≤1000		●
Alloyed heat-treatable steels	<b>1.5131</b> 50MnSi4, <b>1.7003</b> 38Cr2, <b>1.7030</b> 28Cr4 <b>1.5710</b> 36NiCr6, <b>1.7035</b> 41Cr4, <b>1.7225</b> 42CrMo4	≤1000 ≤1400		●
Unalloyed case hard. steels	<b>1.0301</b> (C10), <b>1.1121</b> C10E (Ck10)	≤850		●
Alloyed case hardened steels	<b>1.7276</b> 10CrMo11, <b>1.5125</b> 11MnSi6 <b>1.5752</b> 15NiCr13, <b>1.7131</b> 16MnCr5, <b>1.7264</b> 20CrMo5	≤1000 ≤1400		●
Nitriding steels	<b>1.8504</b> 34CrAl6 <b>1.8519</b> 31CrMoV9, <b>1.8550</b> 34CrAlNi7	≤1000 ≤1400		●
Tool steels	<b>1.1750</b> C75W, <b>1.2067</b> 102Cr6, <b>1.2307</b> 29CrMoV9 <b>1.2080</b> X210Cr12, <b>1.2083</b> X42Cr13, <b>1.2419</b> 105WCr6, <b>1.2767</b> X45NiCrMo4	≤850 ≤1400		●
High speed steels	<b>1.3243</b> S 6-5-2-5, <b>1.3343</b> S 6-5-2, <b>1.3344</b> S 6-5-3	≤1400		●
Spring steels	<b>1.5026</b> 55Si7, <b>1.7176</b> 55Cr3, <b>1.8159</b> 51CrV4 (51CrV4)		≤350 HB	●
Stainless steels, sulphured	<b>1.4005</b> X12CrS13, <b>1.4104</b> X14CrMoS17, <b>1.4105</b> X6CrMoS17, <b>1.4305</b> X8CrNiS18-9	≤900		●
austenitic	<b>1.4301</b> X5CrNi18-10 (V2A), <b>1.4541</b> X6CrNiTi18-10, <b>1.4571</b> X6CrNiMoTi 17-12-2 (V4A)	≤1100		●
martensitic	<b>1.4057</b> X20CrNi172 (X17CrNi16-2), <b>1.4122</b> X39CrMo17-1, <b>1.4521</b> X2CrMoTi18-2	≤1500		●
Hardened steels	-		≤48 HRC ≤66 HRC	●
Special alloys	Nimonic, Inconel, Monel, Hastelloy	≤2000		●
Cast iron	<b>0.6010</b> EN-GJL-100 (GG10), <b>0.6020</b> EN-GJL-200 (GG20) <b>0.6025</b> EN-GJL-250 (GG25), <b>0.6035</b> EN-GJL-350 (GG35)		≤240 HB ≤350 HB	●
Spheroidal graphite iron and malleable cast iron	<b>0.7040</b> EN-GJS-400-15 (GGG40), <b>0.7050</b> EN-GJS-500-7 (GGG50), <b>0.8035</b> EN-GJMW-350-4 (GTW35) <b>0.7060</b> EN-GJS-600-3 (GGG60), <b>0.7070</b> EN-GJS-700-2 (GGG70), <b>0.8170</b> EN-GJMB-700-2 (GTS70)		≤240 HB ≤350 HB	●
Chilled cast iron	-		≤350 HB	●
Ti and Ti-alloys	<b>3.7024</b> Ti99.5, <b>3.7114</b> TiAl5Sn2.5, <b>3.7124</b> TiCu2 <b>3.7154</b> TiAl6Zr5, <b>3.7165</b> TiAl6V4, <b>3.7184</b> TiAl4Mo4Sn2.5, - TiAl8Mo1V1	≤850 ≤1400		●
Aluminium and Al-alloys	<b>3.0255</b> Al99.5, <b>3.2315</b> AlMgSi1, <b>3.3515</b> AlMg1	≤400		●
Al wrought alloys	<b>3.0615</b> AlMgSiPb, <b>3.1325</b> AlCuMg1, <b>3.3245</b> AlMg3Si, <b>3.4365</b> AlZnMgCu1.5	≤650		●
Al cast alloys ≤ 10 % Si	<b>3.2131</b> G-AlSi5Cu1, <b>3.2153</b> G-AlSi7Cu3, <b>3.2573</b> G-AlSi9	≤600		●
≤ 24 % Si	<b>3.2581</b> G-AlSi12, <b>3.2583</b> G-AlSi12Cu, - G-AlSi12CuNiMg	≤600		●
Magnesium alloys	<b>3.5200</b> MgMn2, <b>3.5812.05</b> G-MgAl8Zn1, <b>3.5612.05</b> G-MgAl6Zn1	≤400		○
Copper, low-alloyed	<b>2.0070</b> SE-Cu, <b>2.1020</b> CuSn6, <b>2.1096</b> G-CuSn5ZnPb	≤500		●
Brass, short-chipping	<b>2.0380</b> CuZn39Pb2, <b>2.0401</b> CuZn39Pb3, <b>2.0410</b> CuZn43Pb2	≤600		●
long-chipping	<b>2.0250</b> CuZn20, <b>2.0280</b> CuZn33, <b>2.0332</b> CuZn37Pb0.5	≤600		●
Bronze, short-chipping	<b>2.1090</b> CuSn7ZnPb, <b>2.1170</b> CuPb5Sn5, <b>2.1176</b> CuPb10Sn <b>2.0790</b> CuNi18Zn19Pb	≤600 ≤850		●
Bronze, long-chipping	<b>2.0916</b> CuAl5, <b>2.0960</b> CuAl9Mn, <b>2.1050</b> CuSn10 <b>2.0980</b> CuAl11Ni, <b>2.1247</b> CuBe2	≤850 ≤1000		●
Duroplastics	Bakelit, Resopal, Pertinax, Moltopren	≤150		○
Thermoplastics	Plexiglass, Hostalen, Novodur, Makralon	≤100		○
New cast materials CGI	<b>EN-GJV250</b> (GGV25), <b>EN-GJV350</b> (GGV35) <b>EN-GJV400</b> (GGV40), <b>EN-GJV500</b> (GGV50), SiMo 6		≤220 HB ≤300 HB	●
New cast materials ADI	<b>EN-GJS-800-8</b> (ADI800), <b>EN-GJS-1000-5</b> (ADI1000) <b>EN-GJS-1200-2</b> (ADI1200), <b>EN-GJS-1400-1</b> (ADI1400)	≤1000 ≤1400		●
Kevlar	Kevlar	≤1000		○
Glass, carbon conc. plastics	GRP/CFRP	≤1000		○

- bright    ● steam tempered    ● nitrided    ● TiAlN    ● TiAlN nanoA    ● Carbo    ● TiN

Technical section

# Countersinks

## Countersinks

436	437	438	470	471	472	473
1866	1866	1866	334	334	334	334
HSS	HSS	HSS	HSS	HSS	HSS	HSS
						
90°	90°	90°	60°	60°	60°	60°
			A	B	C	D



V <sub>c</sub> m/min	Feed column no.						
32	85	85	85	85	85	85	85
30	85	85	85	84	84	85	85
32	85	85	85	85	85	85	85
30	85	85	85	84	84	85	85
32	85	85	85	84	84	85	85
30	85	85	85	84	84	85	85
20	84	84	84	84	84	84	84
15	84	84	84	84	84	84	84
12	84	84	84	84	84	84	84
25	85	85	85	85	85	85	85
15	84	84	84	84	84	84	84
10	84	84	84	84	84	84	84
15	85	85	85	84	84	85	85
12	84	84	84	84	84	84	84
17	84	84	84	84	84	84	84
15	84	84	84	84	84	84	84
15	84	84	84	84	84	84	84
10	84	84	84	84	84	84	84
16	84	84	84	84	84	84	84
12	84	84	84	84	84	84	84
14	84	84	84	84	84	84	84
8	84	84	84	84	84	84	84
25	85	85	85	84	84	85	85
16	84	84	84	84	84	84	84
22	84	84	84	84	84	84	84
20	84	84	84	84	84	84	84
8	84	84	84	84	84	84	84
15	85	85	85	85	85	85	85
10	85	85	85	84	84	85	85
90	85	85	85	85	85	85	85
70	86	86	86	85	85	86	86
40	85	85	85	85	85	85	85
30	85	85	85	85	85	85	85
100	86	86	86	85	85	86	86
60	84	84	84	84	84	84	84
80	85	85	85	84	84	85	85
50	85	85	85	84	84	85	85
30	86	86	86	85	85	86	86
26	86	86	86	85	85	86	86
24	86	86	86	85	85	86	86
20	86	86	86	85	85	86	86
30	84	84	84	84	84	84	84
40	85	85	85	84	84	85	85
25	85	85	85	84	84	85	85
16	84	84	84	84	84	84	84
70	84	84	84	84	84	84	84

 bright  
  steam tempered  
  nitrided  
  TiAN  
  TiAN nanoA  
  Carbo  
  TiN

Tools with bold feed column no. are preferred choice.

To select the optimal tool and the recommended machining parameters for your application, please also use the electronic version of the GuhringNavigator on the internet: [www.guehring.de](http://www.guehring.de).

<b>Guhring no.</b>
<b>Standard/DIN</b>
<b>Tool material</b>
<b>Surface finish</b>
<b>Angle of taper</b>
<b>Type/Form</b>

Counter-sink Ø mm	Feed column no.					
	81	82	83	84	85	86
	f (mm/rev.)					
<b>2.00</b>	0.03	0.04	0.06	0.08	0.10	0.13
<b>2.50</b>	0.03	0.05	0.07	0.10	0.13	0.16
<b>3.15</b>	0.03	0.05	0.08	0.11	0.15	0.20
<b>4.00</b>	0.04	0.06	0.09	0.13	0.17	0.22
<b>5.00</b>	0.04	0.07	0.10	0.14	0.18	0.23
<b>6.30</b>	0.04	0.07	0.12	0.15	0.19	0.24
<b>8.00</b>	0.05	0.08	0.13	0.16	0.20	0.25
<b>10.00</b>	0.06	0.09	0.14	0.17	0.22	0.26
<b>12.50</b>	0.06	0.10	0.15	0.19	0.23	0.28
<b>16.00</b>	0.07	0.11	0.17	0.21	0.26	0.31
<b>20.00</b>	0.08	0.13	0.18	0.23	0.28	0.33
<b>25.00</b>	0.09	0.15	0.21	0.26	0.30	0.38
<b>31.50</b>	0.12	0.17	0.24	0.30	0.36	0.42
<b>40.00</b>	0.14	0.21	0.28	0.34	0.40	0.46
<b>50.00</b>	0.17	0.24	0.31	0.36	0.42	0.48
<b>63.00</b>	0.20	0.27	0.33	0.38	0.44	0.50
<b>80.00</b>	0.23	0.30	0.35	0.40	0.46	0.52
<b>100.00</b>	0.25	0.30	0.35	0.40	0.46	0.52











- Coolant:
- Air
  - Neat oil
  - Soluble oil

Material group	Material examples, new description (old description in brackets) Figures in bold = material no. to DIN EN	Tensile str. MPa (N/mm <sup>2</sup> )	Hard- ness	Coolant
Common structural steels	<b>1.0035</b> S185(St33), <b>1.0486</b> P275N(StE285), <b>1.0345</b> P235GH(H1), <b>1.0425</b> P265GH(H2) <b>1.0050</b> E295 (St50-2), <b>1.0070</b> E360 (St70-2), <b>1.8937</b> P500NH (WStE500)	≤500 ≤1000		●
Free-cutting steels	<b>1.0718</b> 11SMnPb30 (9SMnPb28), <b>1.0736</b> 11SMn37 (9SMn36) <b>1.0727</b> 46S20 (45S20), <b>1.0728</b> (60S20), <b>1.0757</b> 46SPb20 (45SPb20)	≤850 ≤1000		●
Unalloyed heat-treatable steels	<b>1.0402</b> C22, <b>1.1178</b> C30E (Ck30) <b>1.0503</b> C45, <b>1.1191</b> C45E (Ck45) <b>1.0601</b> C60, <b>1.1221</b> C60E (Ck60)	≤700 ≤850 ≤1000		●
Alloyed heat-treatable steels	<b>1.5131</b> 50MnSi4, <b>1.7003</b> 38Cr2, <b>1.7030</b> 28Cr4 <b>1.5710</b> 36NiCr6, <b>1.7035</b> 41Cr4, <b>1.7225</b> 42CrMo4	≤1000 ≤1400		●
Unalloyed case hard. steels	<b>1.0301</b> (C10), <b>1.1121</b> C10E (Ck10)	≤850		●
Alloyed case hardened steels	<b>1.7276</b> 10CrMo11, <b>1.5125</b> 11MnSi6 <b>1.5752</b> 15NiCr13, <b>1.7131</b> 16MnCr5, <b>1.7264</b> 20CrMo5	≤1000 ≤1400		●
Nitriding steels	<b>1.8504</b> 34CrAl6 <b>1.8519</b> 31CrMoV9, <b>1.8550</b> 34CrAlNi7	≤1000 ≤1400		●
Tool steels	<b>1.1750</b> C75W, <b>1.2067</b> 102Cr6, <b>1.2307</b> 29CrMoV9 <b>1.2080</b> X210Cr12, <b>1.2083</b> X42Cr13, <b>1.2419</b> 105WCr6, <b>1.2767</b> X45NiCrMo4	≤850 ≤1400		●
High speed steels	<b>1.3243</b> S 6-5-2-5, <b>1.3343</b> S 6-5-2, <b>1.3344</b> S 6-5-3	≤1400		●
Spring steels	<b>1.5026</b> 55Si7, <b>1.7176</b> 55Cr3, <b>1.8159</b> 51CrV4 (51CrV4)		≤350 HB	●
Stainless steels, sulphured	<b>1.4005</b> X12CrS13, <b>1.4104</b> X14CrMoS17, <b>1.4105</b> X6CrMoS17, <b>1.4305</b> X8CrNiS18-9	≤900		●
austenitic	<b>1.4301</b> X5CrNi18-10 (V2A), <b>1.4541</b> X6CrNiTi18-10, <b>1.4571</b> X6CrNiMoTi 17-12-2 (V4A)	≤1100		●
martensitic	<b>1.4057</b> X20CrNi172 (X17CrNi16-2), <b>1.4122</b> X39CrMo17-1, <b>1.4521</b> X2CrMoTi18-2	≤1500		●
Hardened steels	-		≤48 HRC ≤66 HRC	●
Special alloys	Nimonic, Inconel, Monel, Hastelloy	≤2000		●
Cast iron	<b>0.6010</b> EN-GJL-100 (GG10), <b>0.6020</b> EN-GJL-200 (GG20) <b>0.6025</b> EN-GJL-250 (GG25), <b>0.6035</b> EN-GJL-350 (GG35)		≤240 HB ≤350 HB	●
Spheroidal graphite iron and malleable cast iron	<b>0.7040</b> EN-GJS-400-15 (GGG40), <b>0.7050</b> EN-GJS-500-7 (GGG50), <b>0.8035</b> EN-GJMW-350-4 (GTW35) <b>0.7060</b> EN-GJS-600-3 (GGG60), <b>0.7070</b> EN-GJS-700-2 (GGG70), <b>0.8170</b> EN-GJMB-700-2 (GTS70)		≤240 HB ≤350 HB	●
Chilled cast iron	-		≤350 HB	●
Ti and Ti-alloys	<b>3.7024</b> Ti99.5, <b>3.7114</b> TiAl5Sn2.5, <b>3.7124</b> TiCu2 <b>3.7154</b> TiAl6Zr5, <b>3.7165</b> TiAl6V4, <b>3.7184</b> TiAl4Mo4Sn2.5, - TiAl8Mo1V1	≤850 ≤1400		●
Aluminium and Al-alloys	<b>3.0255</b> Al99.5, <b>3.2315</b> AlMgSi1, <b>3.3515</b> AlMg1	≤400		●
Al wrought alloys	<b>3.0615</b> AlMgSiPb, <b>3.1325</b> AlCuMg1, <b>3.3245</b> AlMg3Si, <b>3.4365</b> AlZnMgCu1.5	≤650		●
Al cast alloys ≤ 10 % Si	<b>3.2131</b> G-AlSi5Cu1, <b>3.2153</b> G-AlSi7Cu3, <b>3.2573</b> G-AlSi9	≤600		●
≤ 24 % Si	<b>3.2581</b> G-AlSi12, <b>3.2583</b> G-AlSi12Cu, - G-AlSi12CuNiMg	≤600		●
Magnesium alloys	<b>3.5200</b> MgMn2, <b>3.5812.05</b> G-MgAl8Zn1, <b>3.5612.05</b> G-MgAl6Zn1	≤400		○
Copper, low-alloyed	<b>2.0070</b> SE-Cu, <b>2.1020</b> CuSn6, <b>2.1096</b> G-CuSn5ZnPb	≤500		●
Brass, short-chipping	<b>2.0380</b> CuZn39Pb2, <b>2.0401</b> CuZn39Pb3, <b>2.0410</b> CuZn43Pb2	≤600		●
long-chipping	<b>2.0250</b> CuZn20, <b>2.0280</b> CuZn33, <b>2.0332</b> CuZn37Pb0.5	≤600		●
Bronze, short-chipping	<b>2.1090</b> CuSn7ZnPb, <b>2.1170</b> CuPb5Sn5, <b>2.1176</b> CuPb10Sn <b>2.0790</b> CuNi18Zn19Pb	≤600 ≤850		●
Bronze, long-chipping	<b>2.0916</b> CuAl5, <b>2.0960</b> CuAl9Mn, <b>2.1050</b> CuSn10 <b>2.0980</b> CuAl11Ni, <b>2.1247</b> CuBe2	≤850 ≤1000		●
Duroplastics	Bakelit, Resopal, Pertinax, Moltopren	≤150		○
Thermoplastics	Plexiglass, Hostalen, Novodur, Makralon	≤100		○
New cast materials CGI	<b>EN-GJV250</b> (GGV25), <b>EN-GJV350</b> (GGV35) <b>EN-GJV400</b> (GGV40), <b>EN-GJV500</b> (GGV50), SiMo 6		≤220 HB ≤300 HB	●
New cast materials ADI	<b>EN-GJS-800-8</b> (ADI800), <b>EN-GJS-1000-5</b> (ADI1000) <b>EN-GJS-1200-2</b> (ADI1200), <b>EN-GJS-1400-1</b> (ADI1400)	≤1000 ≤1400		●
Kevlar	Kevlar	≤1000		○
Glass, carbon conc. plastics	GRP/CFRP	≤1000		○

- bright    ● steam tempered    ● nitrided    ● TiAlN    ● TiAlN nanoA    ● Carbo    ● TiN

# Countersinks

## Countersinks

474	475	476	477	478	479	480	481	1326	327	328
335	335	335	335	347	347	G.S.	G.S.	335	335	335
HSS	HSS	HSS	HSS	HSS	HSS	HSS	HSS	HSS	HSS	HSS
 $\frac{>0}{-0,00}$				 $\frac{>0}{-0,00}$						
90°	90°	90°	90°	120°	120°	120°	120°	90°	90°	90°
A	B	C	D	A	B			C	C	D



V <sub>c</sub> m/min	Feed column no.								V <sub>c</sub> m/min	Feed column no.	V <sub>c</sub> m/min	Feed column no.	
32	85	85	86	86	85	85	85	85	37	86	35	86	86
30	85	85	85	85	84	84	85	85	35	85	33	85	85
32	85	85	86	86	85	85	85	85	37	86	35	86	86
30	85	85	85	85	84	84	85	85	35	85	33	85	85
32	85	85	85	85	84	84	85	85	37	85	35	85	85
30	85	85	85	85	84	84	85	85	35	85	33	85	85
20	84	84	85	85	84	84	84	84	23	85	22	85	85
15	84	84	85	85	84	84	84	84	17	85	17	85	85
12	84	84	84	84	84	84	84	84	14	84	13	84	84
25	85	85	86	86	85	85	85	85	29	86	28	86	86
15	84	84	85	85	84	84	84	84	17	85	17	85	85
10	84	84	84	84	84	84	84	84	12	84	11	84	84
15	85	85	85	85	84	84	85	85	17	85	17	85	85
12	84	84	84	84	84	84	84	84	14	84	13	84	84
17	84	84	85	85	84	84	84	84	20	85	19	85	85
15	84	84	84	84	84	84	84	84	17	84	17	84	84
15	84	84	84	84	84	84	84	84	17	84	17	84	84
10	84	84	84	84	84	84	84	84	12	84	11	84	84
16	84	84	85	85	84	84	84	84	18	85	18	85	85
12	84	84	84	84	84	84	84	84	14	84	13	84	84
14	84	84	84	84	84	84	84	84	16	84	15	84	84
8	84	84	84	84	84	84	84	84	9	84	9	84	84
25	85	85	85	85	84	84	85	85	29	85	28	85	85
16	84	84	85	85	84	84	84	84	18	85	18	85	85
22	84	84	85	85	84	84	84	84	25	85	24	85	85
20	84	84	84	84	84	84	84	84	23	84	22	84	84
8	84	84	84	84	84	84	84	84	9	84	9	84	84
15	85	85	86	86	85	85	85	85	17	86	17	86	86
10	85	85	85	85	84	84	85	85	12	85	11	85	85
90	85	85	86	86	85	85	85	85	104	86	99	86	86
70	86	86	86	86	85	85	86	86	81	86	77	86	86
40	85	85	86	86	85	85	85	85	46	86	44	86	86
30	85	85	86	86	85	85	85	85	35	86	33	86	86
100	86	86	86	86	85	85	86	86	115	86	110	86	86
60	84	84	85	85	84	84	84	84	69	85	66	85	85
80	85	85	85	85	84	84	85	85	92	85	88	85	85
50	85	85	85	85	84	84	85	85	58	85	55	85	85
30	86	86	86	86	85	85	86	86	35	86	33	86	86
26	86	86	86	86	85	85	86	86	30	86	29	86	86
24	86	86	86	86	85	85	86	86	28	86	26	86	86
20	86	86	86	86	85	85	86	86	23	86	22	86	86
30	84	84	85	85	84	84	84	84	35	85	33	85	85
40	85	85	85	85	84	84	85	85	46	85	44	85	85
25	84	84	85	85	84	84	85	85	25	85	25	85	85
16	84	84	84	84	84	84	84	84	16	84	16	84	84
70	84	84	85	85	84	84	84	84	81	85	77	85	85

 bright  
  steam tempered  
  nitrided  
  TiAlN  
  TiAlN nanoA  
  Carbo  
  TiN

Tools with bold feed column no. are preferred choice.

To select the optimal tool and the recommended machining parameters for your application, please also use the electronic version of the GuhringNavigator on the internet: [www.guehring.de](http://www.guehring.de).

<b>Guhring no.</b>
<b>Standard/DIN</b>
<b>Tool material</b>
<b>Surface finish</b>
<b>Angle of taper</b>
<b>Type/Form</b>

Counter-sink Ø mm	Feed column no.					
	81	82	83	84	85	86
	f (mm/rev.)					
<b>2.00</b>	0.03	0.04	0.06	0.08	0.10	0.13
<b>2.50</b>	0.03	0.05	0.07	0.10	0.13	0.16
<b>3.15</b>	0.03	0.05	0.08	0.11	0.15	0.20
<b>4.00</b>	0.04	0.06	0.09	0.13	0.17	0.22
<b>5.00</b>	0.04	0.07	0.10	0.14	0.18	0.23
<b>6.30</b>	0.04	0.07	0.12	0.15	0.19	0.24
<b>8.00</b>	0.05	0.08	0.13	0.16	0.20	0.25
<b>10.00</b>	0.06	0.09	0.14	0.17	0.22	0.26
<b>12.50</b>	0.06	0.10	0.15	0.19	0.23	0.28
<b>16.00</b>	0.07	0.11	0.17	0.21	0.26	0.31
<b>20.00</b>	0.08	0.13	0.18	0.23	0.28	0.33
<b>25.00</b>	0.09	0.15	0.21	0.26	0.30	0.38
<b>31.50</b>	0.12	0.17	0.24	0.30	0.36	0.42
<b>40.00</b>	0.14	0.21	0.28	0.34	0.40	0.46
<b>50.00</b>	0.17	0.24	0.31	0.36	0.42	0.48
<b>63.00</b>	0.20	0.27	0.33	0.38	0.44	0.50
<b>80.00</b>	0.23	0.30	0.35	0.40	0.46	0.52
<b>100.00</b>	0.25	0.30	0.35	0.40	0.46	0.52

- Coolant:
- Air
  - Neat oil
  - Soluble oil

Material group	Material examples, new description (old description in brackets) Figures in bold = material no. to DIN EN	Tensile str. MPa (N/mm <sup>2</sup> )	Hard- ness	Coolant
Common structural steels	<b>1.0035</b> S185(St33), <b>1.0486</b> P275N(StE285), <b>1.0345</b> P235GH(H1), <b>1.0425</b> P265GH(H2) <b>1.0050</b> E295 (St50-2), <b>1.0070</b> E360 (St70-2), <b>1.8937</b> P500NH (WStE500)	≤500 ≤1000		●
Free-cutting steels	<b>1.0718</b> 11SMnPb30 (9SMnPb28), <b>1.0736</b> 11SMn37 (9SMn36) <b>1.0727</b> 46S20 (45S20), <b>1.0728</b> (60S20), <b>1.0757</b> 46SPb20 (45SPb20)	≤850 ≤1000		●
Unalloyed heat-treatable steels	<b>1.0402</b> C22, <b>1.1178</b> C30E (Ck30) <b>1.0503</b> C45, <b>1.1191</b> C45E (Ck45) <b>1.0601</b> C60, <b>1.1221</b> C60E (Ck60)	≤700 ≤850 ≤1000		●
Alloyed heat-treatable steels	<b>1.5131</b> 50MnSi4, <b>1.7003</b> 38Cr2, <b>1.7030</b> 28Cr4 <b>1.5710</b> 36NiCr6, <b>1.7035</b> 41Cr4, <b>1.7225</b> 42CrMo4	≤1000 ≤1400		●
Unalloyed case hard. steels	<b>1.0301</b> (C10), <b>1.1121</b> C10E (Ck10)	≤850		●
Alloyed case hardened steels	<b>1.7276</b> 10CrMo11, <b>1.5125</b> 11MnSi6 <b>1.5752</b> 15NiCr13, <b>1.7131</b> 16MnCr5, <b>1.7264</b> 20CrMo5	≤1000 ≤1400		●
Nitriding steels	<b>1.8504</b> 34CrAl6 <b>1.8519</b> 31CrMoV9, <b>1.8550</b> 34CrAlNi7	≤1000 ≤1400		●
Tool steels	<b>1.1750</b> C75W, <b>1.2067</b> 102Cr6, <b>1.2307</b> 29CrMoV9 <b>1.2080</b> X210Cr12, <b>1.2083</b> X42Cr13, <b>1.2419</b> 105WCr6, <b>1.2767</b> X45NiCrMo4	≤850 ≤1400		●
High speed steels	<b>1.3243</b> S 6-5-2-5, <b>1.3343</b> S 6-5-2, <b>1.3344</b> S 6-5-3	≤1400		●
Spring steels	<b>1.5026</b> 55Si7, <b>1.7176</b> 55Cr3, <b>1.8159</b> 51CrV4 (51CrV4)		≤350 HB	●
Stainless steels, sulphured	<b>1.4005</b> X12CrS13, <b>1.4104</b> X14CrMoS17, <b>1.4105</b> X6CrMoS17, <b>1.4305</b> X8CrNiS18-9	≤900		●
austenitic	<b>1.4301</b> X5CrNi18-10 (V2A), <b>1.4541</b> X6CrNiTi18-10, <b>1.4571</b> X6CrNiMoTi 17-12-2 (V4A)	≤1100		●
martensitic	<b>1.4057</b> X20CrNi172 (X17CrNi16-2), <b>1.4122</b> X39CrMo17-1, <b>1.4521</b> X2CrMoTi18-2	≤1500		●
Hardened steels	-		≤48 HRC ≤66 HRC	●
Special alloys	Nimonic, Inconel, Monel, Hastelloy	≤2000		●
Cast iron	<b>0.6010</b> EN-GJL-100 (GG10), <b>0.6020</b> EN-GJL-200 (GG20) <b>0.6025</b> EN-GJL-250 (GG25), <b>0.6035</b> EN-GJL-350 (GG35)		≤240 HB ≤350 HB	●
Spheroidal graphite iron and malleable cast iron	<b>0.7040</b> EN-GJS-400-15 (GGG40), <b>0.7050</b> EN-GJS-500-7 (GGG50), <b>0.8035</b> EN-GJMW-350-4 (GTW35) <b>0.7060</b> EN-GJS-600-3 (GGG60), <b>0.7070</b> EN-GJS-700-2 (GGG70), <b>0.8170</b> EN-GJMB-700-2 (GTS70)		≤240 HB ≤350 HB	●
Chilled cast iron	-		≤350 HB	●
Ti and Ti-alloys	<b>3.7024</b> Ti99.5, <b>3.7114</b> TiAl5Sn2.5, <b>3.7124</b> TiCu2 <b>3.7154</b> TiAl6Zr5, <b>3.7165</b> TiAl6V4, <b>3.7184</b> TiAl4Mo4Sn2.5, - TiAl8Mo1V1	≤850 ≤1400		●
Aluminium and Al-alloys	<b>3.0255</b> Al99.5, <b>3.2315</b> AlMgSi1, <b>3.3515</b> AlMg1	≤400		●
Al wrought alloys	<b>3.0615</b> AlMgSiPb, <b>3.1325</b> AlCuMg1, <b>3.3245</b> AlMg3Si, <b>3.4365</b> AlZnMgCu1.5	≤650		●
Al cast alloys ≤ 10 % Si	<b>3.2131</b> G-AlSi5Cu1, <b>3.2153</b> G-AlSi7Cu3, <b>3.2573</b> G-AlSi9	≤600		●
≤ 24 % Si	<b>3.2581</b> G-AlSi12, <b>3.2583</b> G-AlSi12Cu, - G-AlSi12CuNiMg	≤600		●
Magnesium alloys	<b>3.5200</b> MgMn2, <b>3.5812.05</b> G-MgAl8Zn1, <b>3.5612.05</b> G-MgAl6Zn1	≤400		○
Copper, low-alloyed	<b>2.0070</b> SE-Cu, <b>2.1020</b> CuSn6, <b>2.1096</b> G-CuSn5ZnPb	≤500		●
Brass, short-chipping	<b>2.0380</b> CuZn39Pb2, <b>2.0401</b> CuZn39Pb3, <b>2.0410</b> CuZn43Pb2	≤600		●
long-chipping	<b>2.0250</b> CuZn20, <b>2.0280</b> CuZn33, <b>2.0332</b> CuZn37Pb0.5	≤600		●
Bronze, short-chipping	<b>2.1090</b> CuSn7ZnPb, <b>2.1170</b> CuPb5Sn5, <b>2.1176</b> CuPb10Sn <b>2.0790</b> CuNi18Zn19Pb	≤600 ≤850		●
Bronze, long-chipping	<b>2.0916</b> CuAl5, <b>2.0960</b> CuAl9Mn, <b>2.1050</b> CuSn10 <b>2.0980</b> CuAl11Ni, <b>2.1247</b> CuBe2	≤850 ≤1000		●
Duroplastics	Bakelit, Resopal, Pertinax, Moltopren	≤150		○
Thermoplastics	Plexiglass, Hostalen, Novodur, Makralon	≤100		○
New cast materials CGI	<b>EN-GJV250</b> (GGV25), <b>EN-GJV350</b> (GGV35) <b>EN-GJV400</b> (GGV40), <b>EN-GJV500</b> (GGV50), SiMo 6		≤220 HB ≤300 HB	●
New cast materials ADI	<b>EN-GJS-800-8</b> (ADI800), <b>EN-GJS-1000-5</b> (ADI1000) <b>EN-GJS-1200-2</b> (ADI1200), <b>EN-GJS-1400-1</b> (ADI1400)	≤1000 ≤1400		●
Kevlar	Kevlar	≤1000		○
Glass, carbon conc. plastics	GRP/CFRP	≤1000		○

- bright    ● steam tempered    ● nitrided    ● TiAlN    ● TiAlN nanoA    ● Carbo    ● TiN



# Countersinks

## Counterbores

482	483	484	463	485	486	487
373	373	373	375	G.S.	G.S.	G.S.
HSS	HSS	HSS	HSS	HSS	HSS	HSS

with fixed pilot    
 detach. pilot    
 with fixed pilot



V <sub>c</sub> m/min	Feed column no.						
32	85	85	85	85	85	85	85
30	85	85	85	85	85	85	85
32	85	85	85	85	85	85	85
30	85	85	85	85	85	85	85
32	85	85	85	85	85	85	85
30	85	85	85	85	85	85	85
20	84	84	84	84	84	84	84
15	84	84	84	84	84	84	84
12	84	84	84	84	84	84	84
25	85	85	85	85	85	85	85
15	84	84	84	84	84	84	84
10	84	84	84	84	84	84	84
15	85	85	85	84	85	85	85
12	84	84	84	84	84	84	84
17	84	84	84	84	84	84	84
15	84	84	84	84	84	84	84
15	84	84	84	84	84	84	84
10	84	84	84	84	84	84	84
16	84	84	84	84	84	84	84
12	84	84	84	84	84	84	84
14	84	84	84	84	84	84	84
8	84	84	84	84	84	84	84
25	85	85	85	85	85	85	85
16	84	84	84	84	84	84	84
22	84	84	84	84	84	84	84
20	84	84	84	84	84	84	84
8	84	84	84	84	84	84	84
15	85	85	85	85	85	85	85
10	85	85	85	85	85	85	85
90	85	85	85	85	85	85	85
70	86	86	86	86	86	86	86
40	85	85	85	85	85	85	85
30	85	85	85	85	85	85	85
100	86	86	86	86	86	86	86
60	84	84	84	84	84	84	84
80	85	85	85	85	85	85	85
50	85	85	85	85	85	85	85
30	86	86	86	86	86	86	86
26	86	86	86	86	86	86	86
24	86	86	86	86	86	86	86
20	86	86	86	86	86	86	86
30	84	84	84	84	84	84	84
40	85	85	85	85	85	85	85
25	85	85	85	85	85	85	85
16	84	84	84	84	84	84	84
70	84	84	84	84	84	84	84

## Spot facers

324	325	326
373	373	373
HSS	HSS	HSS

with fixed pilot

432	433	434	435
1862	1862	1862	1862
HSS-E	HSS-E	HSS-E	HSS-E



V <sub>c</sub> m/min	Feed column no.		
35	85	85	85
33	85	85	85
35	85	85	85
33	85	85	85
35	85	85	85
33	85	85	85
22	84	84	84
17	84	84	84
13	84	84	84
28	85	85	85
17	84	84	84
11	84	84	84
17	85	85	85
13	84	84	84
19	84	84	84
17	84	84	84
17	84	84	84
11	84	84	84
18	84	84	84
13	84	84	84
15	84	84	84
9	84	84	84
28	85	85	85
18	84	84	84
24	84	84	84
22	84	84	84
9	84	84	84
17	85	85	85
11	85	85	85
99	85	85	85
77	86	86	86
44	85	85	85
33	85	85	85
110	86	86	86
66	84	84	84
88	85	85	85
55	85	85	85
33	86	86	86
29	86	86	86
26	86	86	86
22	86	86	86
33	84	84	84
44	85	85	85
25	85	85	85
16	84	84	84
77	84	84	84

V <sub>c</sub> m/min	Feed column no.			
30	82	83	83	83
27	82	82	82	82
30	82	83	83	83
27	82	82	82	82
30	82	82	82	82
27	82	82	82	82
24	81	82	82	82
20	81	82	82	82
15	81	81	81	81
28	82	83	83	83
18	81	82	82	82
12	81	81	81	81
18	81	82	82	82
15	81	81	81	81
20	81	82	82	82
17	81	81	81	81
20	81	81	81	81
12	81	81	81	81
12	81	82	82	82
6	81	81	81	81
8	81	81	81	81
8	81	81	81	81
12	82	82	82	82
10	81	82	82	82
10	81	82	82	82
8	81	81	81	81
5	81	81	81	81
10	82	83	83	83
7	82	82	82	82
100	82	83	83	83
80	83	84	84	84
80	82	83	83	83
70	82	83	83	83
75	83	84	84	84
50	81	82	82	82
60	82	82	82	82
45	82	82	82	82
40	83	84	84	84
36	83	84	84	84
35	83	84	84	84
28	83	84	84	84
25	81	82	82	82
32	82	82	82	82
60	81	82	82	82

bright    
 steam tempered    
 nitrided    
 TiAN    
 TiAN nanoA    
 Carbo    
 S TiN

## Coolant pressure

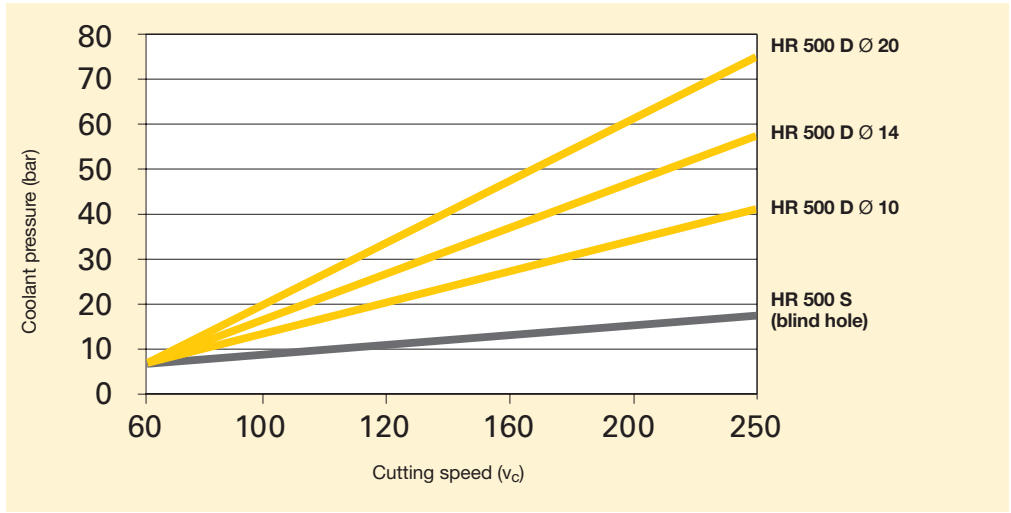

Coolant pressure - cutting speed  
valid for standard dimensions.  
Preconditions: sufficient capacity of coolant pump



Technical section

Adapted cutting speed, an appropriate feed rate and good cooling and lubricating agents should always be a top priority for reaming operations. A further point to be considered is that the reamer always follows the direction of the pre-drilled hole. An exception is the machine bottoming reamer or a very small reamer. Consequently reamers do not correct alignment errors of pre-drilled holes. Errors between the spindle axis and the axis of a pre-drilled hole can be adjusted with the aid of floating holders. The following fault finding chart will be found useful in tracing the cause of some common reaming problems.

Wording:

<i>Desired dim.</i>	Required finish dimension of bore hole, defined as max./min. dimension of tolerance zone
<i>Reaming dim.</i>	the finish dimension reached in fact
<i>„Bore hole“</i>	The reached bore hole after reaming

**1**  
**Holes too large**

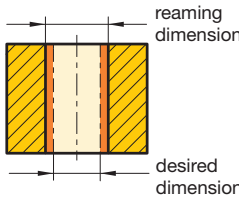

- Tool diameter too large
- Cutting speed too high
- Concentricity error of machine spindle
- Bevel lead of tool too short/uneven
- Cutting edge build up due to wrong cutting speeds oder schlechte Schmierung
- Lubricating agent unsuitable, holes too large due to lubrication

**2**  
**Holes too small**

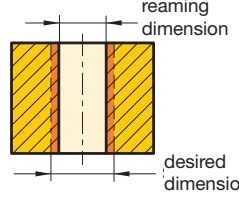

- Reamer blunt. Does not cut, scrapes
- Cutting speed too low
- Component is thin-walled, springs back
- Insufficient stock removal allowance, tool seizes in hole
- Hole is not round due to distortion

**3**  
**Conical hole malformation**

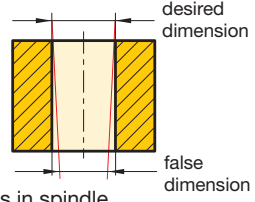

- Tool knocks in spindle
- Bevel lead incorrect
- Axis shifting between tool and pre-drilled hole. Application of floating holders
- Pre-machining inaccurate

**4**  
**Unsatisfactory surface finish**



- Cutting speed too low
- No/insufficient lubrication. Cutting edge build-up.
- Tool damaged, i. e. broken cutting edge
- Material has a tendency to cause build up on cutting edges.
- Concentricity bevel lead incorrect
- Chip evacuation restricted

**5**  
**Misalignment of hole**

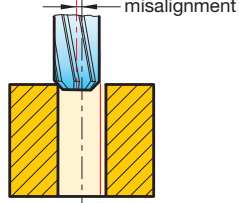

- Pre-drilled hole misaligned
- Concentricity bevel lead incorrect
- Apply floating holder if necessary
- If necessary pilot drill to correct pre-drilled position

**6**  
**Hole has chatter marks**



- Feed too low
- Cutting edge build-up
- Grease content in coolant too low
- Circular lands too small
- Stock removal allowance insufficient
- Tool incorrectly clamped in tool holder
- Machine spindle not concentric

**7**  
**Reamer seizes and breaks**

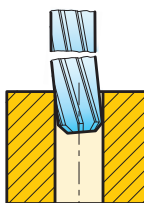

- Position to pilot hole incorrect
- Back taper incorrect
- Circular lands too wide
- Pre-drilled hole is too small
- Bevel lead blunt/ground unevenly
- Feed rate too high
- Chip congestion – increase feed rate to produce shorter chips

**8**  
**Feed scoring marks in hole**



- Cutting speed too low
- Worn cutting edges
- Crumbling on cutting edges
- Build up on cutting edges
- Position to pilot hole incorrect
- Insufficient lubrication

# The most common tolerance zones in $\mu\text{m}$

Nominal diameter in mm		A		B				C			
over	to	9	11	8	9	10	11	8	9	10	11
0	3	+295	+330	+154	+165	+180	+200	+74	+85	+100	+120
		+270	+270	+140	+140	+140	+140	+60	+60	+60	+60
3	6	+300	+345	+158	+170	+188	+215	+88	+100	+118	+145
		+270	+270	+140	+140	+140	+140	+70	+70	+70	+70
6	10	+316	+370	+172	+186	+208	+240	+102	+116	+138	+170
		+280	+280	+150	+150	+150	+150	+80	+80	+80	+80
10	18	+333	+400	+177	+193	+220	+260	+122	+138	+165	+205
		+290	+290	+150	+150	+150	+150	+95	+95	+95	+95
18	30	+352	+430	+193	+212	+244	+290	+143	+162	+194	+240
		+300	+300	+160	+160	+160	+160	+110	+110	+110	+110
30	40	+372	+470	+209	+232	+270	+330	+159	+182	+220	+280
		+310	+310	+170	+170	+170	+170	+120	+120	+120	+120
40	50	+382	+480	+219	+242	+280	+340	+169	+192	+230	+290
		+320	+320	+180	+180	+180	+180	+130	+130	+130	+130
50	65	+414	+530	+236	+264	+310	+380	+186	+214	+260	+330
		+340	+340	+190	+190	+190	+190	+140	+140	+140	+140
65	80	+434	+550	+246	+274	+320	+390	+196	+224	+270	+340
		+360	+360	+200	+200	+200	+200	+150	+150	+150	+150
80	100	+467	+600	+274	+307	+360	+440	+224	+257	+310	+390
		+380	+380	+220	+220	+220	+220	+170	+170	+170	+170
100	120	+497	+630	+294	+327	+380	+460	+234	+267	+320	+400
		+410	+410	+240	+240	+240	+240	+180	+180	+180	+180

Nominal diameter in mm		D					E			F			
over	to	8	9	10	11	12	7	8	9	6	7	8	9
0	3	+34	+45	+60	+80	+120	+24	+28	+39	+12	16	+20	+31
		+20	+20	+20	+20	+20	+14	+14	+14	+6	+6	+6	+6
3	6	+48	+60	+78	+105	+150	+32	+38	+50	+18	+22	+28	+40
		+30	+30	+30	+30	+30	+20	+20	+20	+10	+10	+10	+10
6	10	+62	+76	+98	+130	+190	+40	+47	+61	+22	+28	+35	+49
		+40	+40	+40	+40	+40	+25	+25	+25	+13	+13	+13	+13
10	18	+77	+93	+120	+160	+230	+50	+59	+75	+27	+34	+43	+59
		+50	+50	+50	+50	+50	+32	+32	+32	+16	+16	+16	+16
18	30	+98	+117	+149	+195	+275	+61	+73	+92	+33	+41	+53	+72
		+65	+65	+65	+65	+65	+40	+40	+40	+20	+20	+20	+20
30	50	+119	+142	+180	+240		+75	+89	+112	+41	+50	+64	+87
		+80	+80	+80	+80		+50	+50	+50	+25	+25	+25	+25
50	80	+146	+174	+220	+290		+90	+106	+134	+49	+60	+76	+104
		+100	+100	+100	+100		+60	+60	+60	+30	+30	+30	+30
80	120	+174	+207	+260	+340		+107	+126	+159	+58	+71	+90	+123
		+120	+120	+120	+120		+72	+72	+72	+36	+36	+36	+36
120	180							+148					
								+85					
180	250							+172					
								+100					

# The most common tolerance zones in $\mu\text{m}$

Nominal diameter in mm		G		H							J		
over	to	6	7	6	7	8	9	10	11	12	6	7	8
0	3	+8 +2	+12 +2	+6 0	+10 0	+14 0	+25 0	+40 0	+60 0	+100 0	+2 -4	+4 -6	+6 -8
3	6	+12 +4	+16 +4	+8 0	+12 0	+18 0	+30 0	+48 0	+75 0	+120 0	+5 -3	+6 -6	+10 -8
6	10	+14 +5	+20 +5	+9 0	+15 0	+22 0	+36 0	+58 0	+90 0	+150 0	+5 -4	+8 -7	+12 -10
10	18	+17 +6	+24 +6	+11 0	+18 0	+27 0	+43 0	+70 0	+110 0	+180 0	+6 -5	+10 -8	+15 -12
18	30	+20 +7	+28 +7	+13 0	+21 0	+33 0	+52 0	+84 0	+130 0	+210 0	+8 -5	+12 -9	+20 -13
30	50	+25 +9	+34 +9	+16 0	+25 0	+39 0	+62 0	+100 0	+160 0	+250 0	+10 -6	+14 -11	+24 -15
50	80	+29 +10	+40 +10	+19 0	+30 0	+46 0	+74 0	+120 0	+190 0	+300 0	+13 -6	+18 -12	+28 -18
80	120	+34 +12	+47 +12	+22 0	+35 0	+54 0	+87 0	+140 0	+220 0	+350 0	+16 -6	+22 -13	+34 -20
120	180		+54 +14	+25 0	+40 0	+63 0	+100 0	+160 0	+250 0		+18 -7	+26 -14	+41 -22
180	250		+61 +15	+29 0	+46 0	+72 0	+115 0	+185 0	+290 0		+22 -7	+30 -16	+47 -25

Nominal diameter in mm		JS				K			M		
over	to	6	7	8	9	6	7	8	6	7	8
0	3	+3 -3	+5 -5	+7 -7	+12,5 -12,5	0 -6	0 -10	0 -14	-2 -8	-2 -12	-4 -18
3	6	+4 -4	+6 -6	+9 -9	+15 -15	+2 -6	+3 -9	+5 -13	-1 -9	0 -12	+2 -16
6	10	+4.5 -4.5	+7.5 -7.5	+11 -11	+18 -18	+2 -7	+5 -10	+6 -16	-3 -12	0 -215	+1 -21
10	18	+5.5 -5.5	+9 -9	+13.5 -13.5	+21.5 -21.5	+2 -9	+6 -12	+8 -19	-4 -15	0 -18	+2 -25
18	30	+6.5 -6.5	+10.5 -10.5	+16.5 -16.5	+26 -26	+2 -11	+6 -15	+10 -23	-4 -17	0 -21	+4 -29
30	50	+8 -8	+12.5 -12.5	+19.5 -19.5	+31 -31	+3 -13	+7 -18	+12 -27	-4 -20	0 -25	+5 -34
50	80	+9.5 -9.5	+15 -15	+23 -23	+37 -37	+4 -15	+9 -21	+14 -32	-5 -24	0 -30	+5 -41
80	120	+11 -11	+17.5 -17.5	+27 -27	+43.5 -43.5	+4 -18	+10 -25	+16 -38	-6 -28	0 -35	+6 -48
120	180					+4 -21	+12 -28				
180	250					+5 -24	+13 -33				

# The most common tolerance zones in $\mu\text{m}$

Nominal diameter in mm over to		N						P			R	
		6	7	8	9	10	11	6	7	9	6	7
0	3	-4	-4	-4	-4	-4	-4	-6	-6	-6	-10	-10
		-10	-14	-8	-29	-44	-64	-12	-16	-31	-16	-20
3	6	-5	-4	-2	0	0	0	-9	-8	-12	-12	-11
		-13	-16	-20	-30	-48	-75	-17	-20	-42	-20	-23
6	10	-7	-4	-3	0	0	0	-12	-9	-15	-16	-13
		-16	-19	-25	-36	-58	-90	-21	-24	-51	-25	-28
10	18	-9	-5	-3	0	0	0	-15	-11	-18	-20	-16
		-20	-23	-30	-43	-70	-110	-26	-29	-61	-31	-34
18	30	-11	-7	-3	0	0	0	-18	-14	-22	-24	-20
		-24	-28	-36	-52	-84	-130	-31	-35	-74	-37	-41
30	50	-12	-8	-3	0	0	0	-21	-17	-26	-29	-25
		-28	-33	-42	-62	-100	-160	-37	-42	-88	-45	-50
50	65	-14	-9	-4	0	0	0	-26	-21	-32	-35	-30
		-33	-39	-50	-74	-120	-190	-45	-51	-106	-54	-60
65	80	-14	-9	-4	0	0	0	-26	-21	-32	-37	-32
		-33	-39	-50	-74	-120	-190	-45	-51	-106	-56	-62
80	100	-16	-10	-4	0	0	0	-30	-24	-37	-44	-38
		-38	-45	-58	-87	-140	-220	-52	-59	-124	-66	-73
100	120	-16	-10	-4	0	0	0	-30	-24		-47	-41
		-38	-45	-58	-87	-140	-220	-52	-59		-69	-76

Nominal diameter in mm over to		S		T	U			X		Z	
		6	7	6	6	7	10	10	11	10	11
0	3	-14	-14	-18	-18	-18	-18	-20	-20	-26	-26
		-20	-24	-24	-24	-28	-58	-60	-80	-66	-86
3	6	-16	-15	-20	-20	-19	-23	-28	-28	-35	-35
		-24	-27	-28	-28	-31	-71	-76	-103	-83	-110
6	10	-20	-17	-25	-25	-22	-28	-34	-34	-42	-42
		-29	-32	-34	-34	-37	-86	-92	-124	-100	-132
10	14	-25	-21	-30	-30	-26	-33	-40	-40	-50	-50
		-36	-39	-41	-41	-44	-103	-110	-150	-120	-160
14	18	-25	-21	-30	-30	-26	-33	-45	-45	-60	-60
		-36	-39	-41	-41	-44	-103	-115	-155	-130	-170
18	24	-31	-27	-37	-37	-33	-41	-54	-54	-73	-73
		-44	-48	-50	-50	-54	-125	-138	-184	-157	-203
24	30	-31	-27	-37	-44	-40	-48	-64	-64	-88	-88
		-44	-48	-50	-57	-61	-132	-148	-194	-172	-218
30	40	-38	-34	-43	-55	-51	-60	-80	-80	-112	-112
		-54	-59	-59	-71	-76	-160	-180	-240	-212	-272
40	50	-38	-34	-49	-65	-61	-70	-97	-97	-136	-136
		-54	-59	-65	-81	-86	-170	-197	-257	-236	-296
50	65	-47	-42	-60	-81	-76	-87	-122	-122	-172	-172
		-66	-72	-79	-100	-106	-207	-242	-312	-292	-362
65	80	-53	-48	-69	-96	-91	-102	-146	-146	-210	-210
		-72	-78	-88	-115	-121	-222	-266	-336	-330	-400
80	100	-64	-58	-84	-117	-111	-124	-178	-178	-258	-258
		-86	-93	-106	-139	-146	-264	-318	-398	-398	-478
100	120	-72	-66	-97	-137	-131	-144	-210	-210	-310	-310
		-94	-101	-119	-159	-166	-284	-350	-430	-450	-530

# Manufacturing tolerances

## (tolerance zones A ... G)

### DIN 1420

Nominal diameter in mm		Permissible upper and lower tolerances on nominal reamer diameter $d_1$ in $\mu\text{m}$ for hole tolerance zone									
over	to	A9	A11	B8	B9	B10	B11	C8	C9	C10	C11
1	3	+ 291	+ 321	+ 151	+ 161	+ 174	+ 191	+ 71	+ 81	+ 94	+ 111
		+ 282	+ 300	+ 146	+ 152	+ 160	+ 170	+ 66	+ 72	+ 80	+ 90
3	6	+ 295	+ 333	+ 155	+ 165	+ 180	+ 203	+ 85	+ 95	+ 110	+ 133
		+ 284	+ 306	+ 148	+ 154	+ 163	+ 176	+ 78	+ 84	+ 93	+ 106
6	10	+ 310	+ 356	+ 168	+ 180	+ 199	+ 226	+ 98	+ 110	+ 129	+ 156
		+ 297	+ 324	+ 160	+ 167	+ 178	+ 194	+ 90	+ 97	+ 108	+ 124
10	18	+ 326	+ 383	+ 172	+ 186	+ 209	+ 243	+ 117	+ 131	+ 154	+ 188
		+ 310	+ 344	+ 162	+ 170	+ 184	+ 204	+ 107	+ 115	+ 129	+ 149
18	30	+ 344	+ 410	+ 188	+ 204	+ 231	+ 270	+ 138	+ 154	+ 181	+ 220
		+ 325	+ 364	+ 176	+ 185	+ 201	+ 224	+ 126	+ 135	+ 151	+ 174
30	40	+ 362	+ 446	+ 203	+ 222	+ 255	+ 306	+ 153	+ 172	+ 205	+ 256
		+ 340	+ 390	+ 189	+ 200	+ 220	+ 250	+ 139	+ 150	+ 170	+ 200
40	50	+ 372	+ 456	+ 213	+ 232	+ 265	+ 316	+ 163	+ 182	+ 215	+ 266
		+ 350	+ 400	+ 199	+ 210	+ 230	+ 260	+ 149	+ 160	+ 180	+ 210
50	65	+ 402	+ 501	+ 229	+ 252	+ 292	+ 351	+ 179	+ 202	+ 242	+ 301
		+ 376	+ 434	+ 212	+ 226	+ 250	+ 284	+ 162	+ 176	+ 200	+ 234
65	80	+ 422	+ 521	+ 239	+ 262	+ 302	+ 361	+ 189	+ 212	+ 252	+ 311
		+ 396	+ 454	+ 222	+ 236	+ 260	+ 294	+ 172	+ 186	+ 210	+ 244
80	100	+ 453	+ 567	+ 265	+ 293	+ 339	+ 407	+ 215	+ 243	+ 289	+ 357
		+ 422	+ 490	+ 246	+ 262	+ 290	+ 330	+ 196	+ 212	+ 240	+ 280
100	120	+ 483	+ 597	+ 285	+ 313	+ 359	+ 427	+ 225	+ 253	+ 299	+ 367
		+ 452	+ 520	+ 266	+ 282	+ 310	+ 350	+ 206	+ 222	+ 250	+ 290
120	140	+ 545	+ 672	+ 313	+ 345	+ 396	+ 472	+ 253	+ 285	+ 336	+ 412
		+ 510	+ 584	+ 290	+ 310	+ 340	+ 384	+ 230	+ 250	+ 280	+ 324
140	160	+ 605	+ 732	+ 333	+ 365	+ 416	+ 492	+ 263	+ 295	+ 346	+ 422
		+ 570	+ 644	+ 310	+ 330	+ 360	+ 404	+ 240	+ 260	+ 290	+ 334
160	180	+ 665	+ 792	+ 363	+ 395	+ 446	+ 522	+ 283	+ 315	+ 366	+ 442
		+ 630	+ 704	+ 340	+ 360	+ 390	+ 434	+ 260	+ 280	+ 310	+ 354

Nominal diameter in mm		Permissible upper and lower tolerances on nominal reamer diameter $d_1$ in $\mu\text{m}$ for hole tolerance zone												
over	to	D8	D9	D10	D11	E7	E8	E9	F6	F7	F8	F9	G6	G7
1	3	+ 31	+ 41	+ 54	+ 71	+ 22	+ 25	+ 35	+ 11	+ 14	+ 17	+ 27	+ 7	+ 10
		+ 26	+ 32	+ 40	+ 50	+ 18	+ 20	+ 26	+ 8	+ 10	+ 12	+ 18	+ 4	+ 6
3	6	+ 45	+ 55	+ 70	+ 93	+ 30	+ 35	+ 45	+ 16	+ 20	+ 25	+ 35	+ 10	+ 14
		+ 38	+ 44	+ 53	+ 66	+ 25	+ 28	+ 34	+ 13	+ 15	+ 18	+ 24	+ 7	+ 9
6	10	+ 58	+ 70	+ 89	+ 116	+ 37	+ 43	+ 55	+ 20	+ 25	+ 31	+ 43	+ 12	+ 17
		+ 50	+ 57	+ 68	+ 84	+ 31	+ 35	+ 42	+ 16	+ 19	+ 23	+ 30	+ 8	+ 11
10	18	+ 72	+ 86	+ 109	+ 143	+ 47	+ 54	+ 68	+ 25	+ 31	+ 38	+ 52	+ 15	+ 21
		+ 62	+ 70	+ 84	+ 104	+ 40	+ 44	+ 52	+ 21	+ 24	+ 28	+ 36	+ 11	+ 14
18	30	+ 93	+ 109	+ 136	+ 175	+ 57	+ 68	+ 84	+ 31	+ 37	+ 48	+ 64	+ 18	+ 24
		+ 81	+ 90	+ 106	+ 129	+ 49	+ 56	+ 65	+ 26	+ 29	+ 36	+ 45	+ 13	+ 16
30	50	+ 113	+ 132	+ 165	+ 216	+ 71	+ 83	+ 102	+ 38	+ 46	+ 58	+ 77	+ 22	+ 30
		+ 99	+ 110	+ 130	+ 160	+ 62	+ 69	+ 80	+ 32	+ 37	+ 44	+ 55	+ 16	+ 21
50	80	+ 139	+ 162	+ 202	+ 261	+ 85	+ 99	+ 122	+ 46	+ 55	+ 69	+ 92	+ 26	+ 35
		+ 122	+ 136	+ 160	+ 194	+ 74	+ 82	+ 96	+ 39	+ 44	+ 52	+ 66	+ 19	+ 24
80	120	+ 165	+ 193	+ 239	+ 307	+ 101	+ 117	+ 145	+ 54	+ 65	+ 81	+ 109	+ 30	+ 41
		+ 146	+ 162	+ 190	+ 230	+ 88	+ 98	+ 114	+ 46	+ 52	+ 62	+ 78	+ 22	+ 28
120	180	+ 198	+ 230	+ 281	+ 357	+ 119	+ 138	+ 170	+ 64	+ 77	+ 96	+ 128	+ 35	+ 48
		+ 175	+ 195	+ 225	+ 269	+ 105	+ 115	+ 135	+ 55	+ 63	+ 73	+ 93	+ 26	+ 34

# Manufacturing tolerances

(tolerance zones H ... P)

DIN 1420

Nominal diameter in mm		Permissible upper and lower tolerances on nominal reamer diameter $d_1$ in $\mu\text{m}$ for hole tolerance zone													
over	to	H6	H7	H8	H9	H10	H11	H12	J6	J7	J8	JS6	JS7	JS8	JS9
>1.....3		+5	+8	+11	+21	+34	+51	+85	+1	+2	+3	+2	+3	+4	+8
		+2	+4	+6	+12	+20	+30	+50	-2	-2	-2	-1	-1	-1	-1
>3.....6		+6	+10	+15	+25	+40	+63	+102	+3	+4	+7	+2	+4	+6	+10
		+3	+5	+8	+14	+23	+36	+60	0	-1	0	-1	-1	-1	-1
>6.....10		+7	+12	+18	+30	+49	+76	+127	+3	+5	+8	+3	+5	+7	+12
		+3	+6	+10	+17	+28	+44	+74	-1	-1	0	-1	-1	-1	-1
>10.....18		+9	+15	+22	+36	+59	+93	+153	+4	+7	+10	+3	+6	+8	+15
		+5	+8	+12	+20	+34	+54	+90	0	0	0	-1	-1	-1	-1
>18.....30		+11	+17	+28	+44	+71	+110	+178	+6	+8	+15	+4	+7	+11	+18
		+6	+9	+16	+25	+41	+64	+104	+1	0	+3	-1	-1	-1	-1
>30.....50		+13	+21	+33	+52	+85	+136	+212	+7	+10	+18	+5	+8	+13	+21
		+7	+12	+19	+30	+50	+80	+124	+1	+1	+4	-1	-1	-1	-1
>50.....80		+16	+25	+39	+62	+102	+161	+255	+10	+13	+21	+6	+10	+16	+25
		+9	+14	+22	+36	+60	+94	+150	+3	+2	+4	-1	-1	-1	-1
>80...120		+18	+29	+45	+73	+119	+187	+297	+12	+16	+25	+7	+12	+18	+30
		+10	+16	+26	+42	+70	+110	+174	+4	+3	+6	-1	-1	-1	-1
>120...180		+21	+34	+53	+85	+136	+212	+340	+14	+20	+31	+8	+14	+22	+35
		+12	+20	+30	+50	+80	+124	+200	+5	+6	+8	-1	0	-1	0

  
 Our standard manufacturing accuracy

Nominal diameter in mm		Permissible upper and lower tolerances on nominal reamer diameter $d_1$ in $\mu\text{m}$ for hole tolerance zone													
over	to	K6	K7	K8	M6	M7	M8	N6	N7	N8	N9	N10	N11	P6	P7
1	3	-1	-2	-3	-3	-4		-5	-6	-7	-8	-10	-13	-7	-8
		-4	-6	-8	-6	-8		-8	-10	-12	-17	-24	-34	-10	-12
3	6	0	+1	+2	-3	-2	-1	-7	-6	-5	-5	-8	-12	-11	-10
		-3	-4	-5	-6	-7	-8	-10	-11	-12	-16	-25	-39	-14	-15
6	10	0	+2	+2	-5	-3	-3	-9	-7	-7	-6	-9	-14	-14	-12
		-4	-4	-6	-9	-9	-11	-13	-13	-15	-19	-30	-46	-18	-18
10	18	0	+3	+3	-6	-3	-3	-11	-8	-8	-7	-11	-17	-17	-14
		-4	-4	-7	-10	-10	-13	-15	-15	-18	-23	-36	-56	-21	-21
18	30	0	+2	+5	-6	-4	-1	-13	-11	-8	-8	-13	-20	-20	-1
		-5	-6	-7	-11	-12	-13	-18	-19	-20	-27	-43	-66	-25	-26
30	50	0	+3	+6	-7	-4	-1	-15	-12	-9	-10	-15	-24	-24	-21
		-6	-6	-8	-13	-13	-15	-21	-21	-23	-32	-50	-80	-30	-30
50	80	+1	+4	+7	-8	-5	-2	-17	-14	-11	-12	-18	-29	-29	-26
		-6	-7	-10	-15	-16	-19	-24	-25	-28	-38	-60	-96	-36	-37
80	120	0	+4	+7	-10	-6	-3	-20	-16	-13	-14	-21	-33	-34	-30
		-8	-9	-12	-18	-19	-22	-28	-29	-32	-45	-70	-110	-42	-43
120	180	0	+6	+10	-12	-6	-2	-24	-18	-14	-15	-24	-38	-40	-43
		-9	-8	-13	-21	-20	-25	-33	-32	-37	-50	-80	-126	-49	-48

Technical section



# Manufacturing tolerances

(tolerance zones R ... Z)

DIN 1420

Nominal diameter in mm		Permissible upper and lower tolerances on nominal reamer diameter $d_1$ in $\mu\text{m}$ for hole tolerance zone											
over	to	R6	R7	S6	S7	T6	U6	U7	U10	X10	X11	Z10	Z11
1	3	- 11	- 12	- 15	- 16		- 19	- 20				- 32	
		- 14	- 16	- 18	- 20		- 22	- 24				- 46	
3	6	- 14	- 13	- 18	- 17		- 22	- 21	- 31			- 43	
		- 17	- 18	- 21	- 22		- 25	- 26	- 48			- 60	
6	10	- 18	- 16	- 22	- 20		- 27	- 25	- 37			- 51	
		- 22	- 22	- 26	- 26		- 31	- 31	- 58			- 72	
10	14	- 22	- 19	- 27	- 24		- 32	- 29	- 44			- 61	
		- 26	- 26	- 31	- 31		- 36	- 36	- 69			- 86	
14	18	- 22	- 19	- 27	- 24		- 32	- 29	- 44	- 56		- 71	
		- 26	- 26	- 31	- 31		- 36	- 36	- 69	- 81		- 96	
18	24	- 26	- 24	- 33	- 31		- 39	- 37		- 67		- 86	
		- 31	- 32	- 38	- 39		- 44	- 45		- 97		-116	
24	30	- 26	- 24	- 33	- 31	- 39	- 46	- 44		- 77		-101	-108
		- 31	- 32	- 38	- 39	- 44	- 51	- 52		-107		-131	-154
30	40	- 32	- 29	- 41	- 38	- 46	- 58	- 55		- 95		-127	-136
		- 38	- 38	- 47	- 47	- 52	- 64	- 64		-130		-162	-192
40	50	- 32	- 29	- 41	- 38	- 52	- 68	- 65	- 85	-112		-151	-160
		- 38	- 38	- 47	- 47	- 58	- 74	- 74	-120	-147		-186	-216
50	65	- 38	- 35	- 50	- 47	- 63	- 84	- 81	-105	-140	-151	-190	-201
		- 45	- 46	- 57	- 58	- 70	- 91	- 92	-147	-182	-218	-232	-268
65	80	- 40	- 37	- 56	- 53	- 72	- 99	- 96	-120	-164	-175	-228	-239
		- 47	- 48	- 63	- 64	- 79	-106	-107	-162	-206	-242	-270	-306
80	100	- 48	- 44	- 68	- 64	- 88	-121	-117	-145	-199	-211	-279	-291
		- 56	- 57	- 76	- 77	- 96	-129	-130	-194	-248	-288	-328	-368
100	120	- 51	- 47	- 76	- 72	-101	-141	-137	-165	-231	-243	-331	-343
		- 59	- 60	- 84	- 85	-109	-149	-150	-214	-280	-320	-380	-420
120	140	- 60	- 54	- 89	- 83	-119	-167	-161	-194	-272	-286	-389	-403
		- 69	- 68	- 98	- 97	-128	-176	-175	-250	-328	-374	-445	-491
140	160	- 62	- 56	- 97	- 91	-131	-187	-181	-214	-304	-318	-439	-453
		- 71	- 70	-106	-105	-140	-196	-195	-270	-360	-406	-495	-541
160	180	- 65	- 59	-105	- 99	-143	-207	-201	-234	-334	-348	-489	-503
		- 74	- 73	-114	-113	-152	-216	-215	-290	-390	-436	-545	-591

## DIN ISO 286-1

Range of nominal size mm		IT in $\mu\text{m}$											
		3	4	5	6	7	8	9	10	11	12	13	14
from	1	2	3	4	6	10	14	25	40	60	100	140	250
to	3												
over	3	2.5	4	5	8	12	18	30	48	75	120	180	300
to	6												
over	6	2.5	4	6	9	15	22	36	58	90	150	220	360
to	10												
over	10	3	5	8	11	18	27	43	70	110	180	270	430
to	18												
over	18	4	6	9	13	21	33	52	84	130	210	330	520
to	30												
over	30	4	7	11	16	25	39	62	100	160	250	390	620
to	50												
over	50	5	8	13	19	30	46	74	120	190	300	460	740
to	80												
over	80	6	10	15	22	35	54	87	140	220	350	540	870
to	120												

Example: Basic ISO tolerances for a range of nominal sizes over 18 to 30 mm

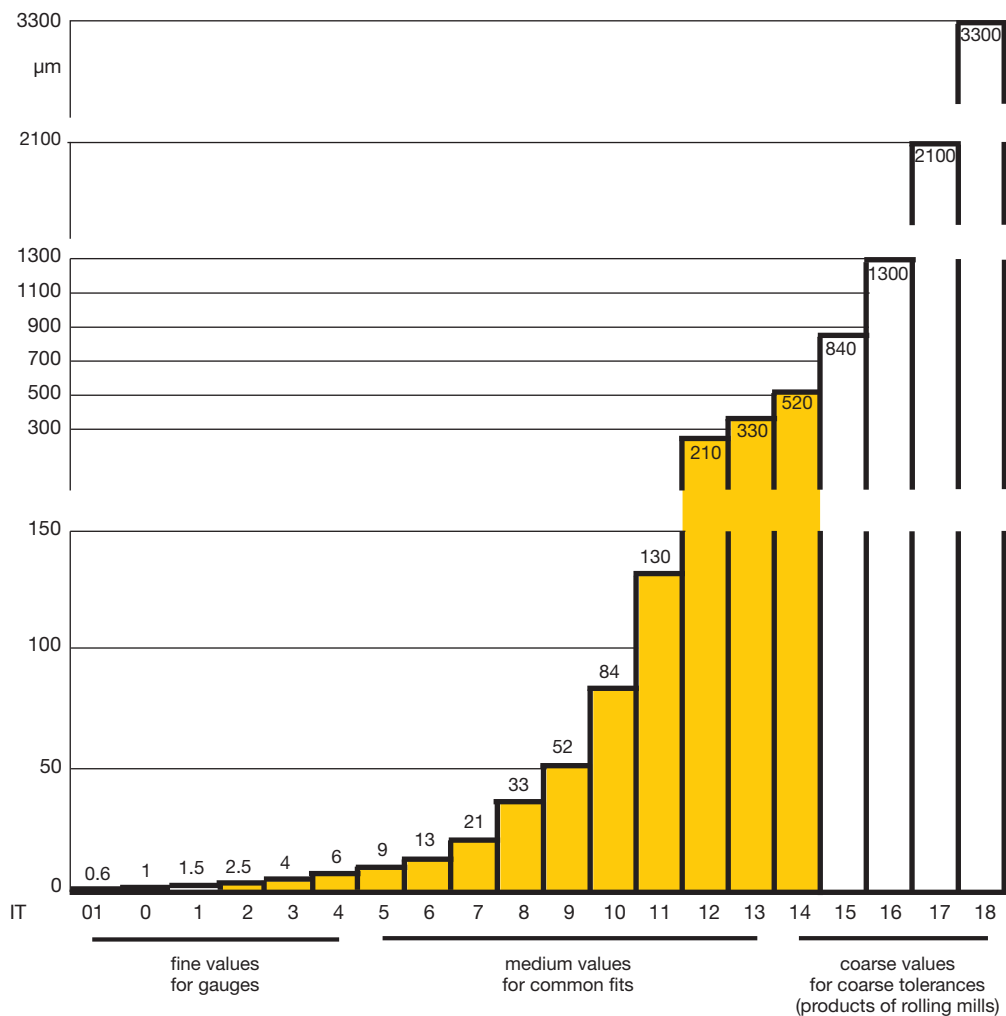

## General remarks for the determination of manufacturing tolerances for reamers

The manufacturing tolerances to DIN 1420 are allocated to certain tolerance zones of the holes to be reamed. Generally they ensure the positioning of reamed holes within the relevant tolerance zone as well as the most economical use of the reamer.

It must, however, be taken into account that the size of the reamed hole depends, in addition to the manufacturing tolerance of the reamer, on various other factors, such as angles of cutting edges; bevel lead of reamer; clamping of the workpiece; the tool holder; condition of the machine; the coolant and on the material of the workpiece. Therefore, from time to time other manufacturing tolerances than IT7 (H7) might prove more advantageous.

However, in the interest of economic production and storage, it is recommended that non-standard manufacturing tolerances are used only in exceptional cases.

For determining the manufacturing tolerances the following well-proven *basic rules* were stipulated:

## Determination of perm. max. and min. sizes of reamers

The largest permitted reamer diameter ranges at about 15% of the approximate hole tolerance (0.15 IT) below the permissible maximum diameter of the hole (see fig.), whereby the value 0.15 IT will be rounded of to the next higher integer or half  $\mu\text{m}$ -value, so that even  $\mu\text{m}$  values are derived for  $d_{1\text{max}}$ . The permissible smallest reamer diameter  $d_{1\text{min}}$  ranges at about 35% of the approximate hole tolerance (0.35 IT) below the permissible maximum diameter  $d_{1\text{max}}$  (ex. 1).

## Simplified determination of permissible max. and min. reamer dimensions

In order to facilitate calculations, the table on page 15 indicates the upper and lower tolerance limits on the nominal diameter  $d_1$  for the most common "H" tolerance zones. With the aid of these tolerance limits the permissible maximum and minimum reamer dimensions can be calculated (ex. 2).

### Example 1

nominal diameter $d_1$	= 20.000 mm
maximum diameter of the hole	= 20.021 mm
hole tolerance (IT 7)	= 0.021 mm
15% of the hole tolerance (0.15 IT 7)	= 0.0031 mm
	$\approx 0.004$ mm
maximum reamer diameter:	
$d_{1\text{max}} = 20.021 - 0.004$	= <u>20.017 mm</u>
manufacturing tolerance of reamer:	
35% of the hole tolerance (0.35 IT 7)	= 0.0073 mm
	$\approx 0.008$ mm

minimum reamer diameter:

$$d_{1\text{min}} = d_{1\text{max}} - 0,35 \text{ IT } 7$$

$$= 20.017 - 0.008 = \underline{20.009 \text{ mm}}$$

### Example 2

nominal diameter $d_1$	= 20.000 mm
upper tol limit (s. table p. 70) + 17 $\mu\text{m}$	= 0.017 mm
lower tol. limit (s. table p. 70) + 9 $\mu\text{m}$	= 0.009 mm
i. e.: $d_{1\text{max}} = 20.000 + 0.017$	= <u>20.017 mm</u>
$d_{1\text{min}} = 20.000 + 0.009$	= 20.009 mm

## Simplified calculation of the permissible maximum and minimum dimensions for reamers

Example: Hole tolerance zone  $\varnothing 20$  H7/nom. dimension  $d_1$  of reamer 20 mm

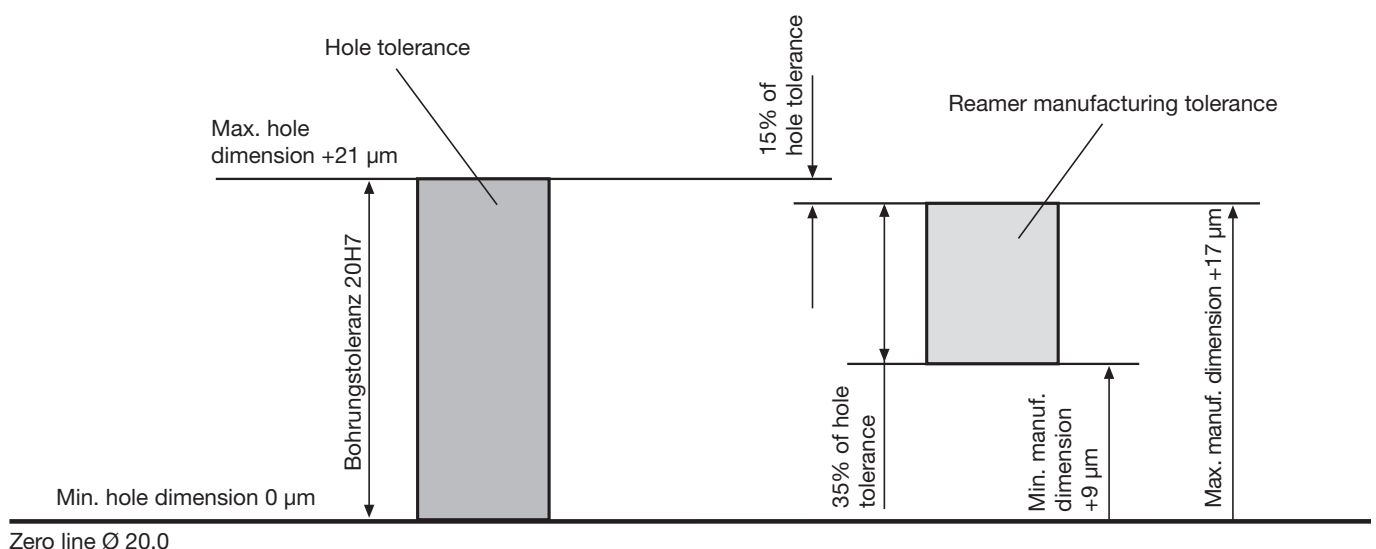

## Designation

For the designation of reamers the ISO abbreviation for the tolerance zone of the hole is indicated after the nominal diameter. Designation of a reamer with nominal diameter  $d_1 = 20$  mm, for hole tolerance H 7:

reamer 20 H 7 DIN ...  
 (" ... ": for DIN no. indication  
 of appropriate reamer)

In special cases, reamers are ordered with maximum and minimum dimensions deviating from this standard, the ISO abbreviation for the hole tolerance zone must be replaced

by the upper and lower tolerance limit of the reamer in  $\mu\text{m}$ , e.g. for a reamer with a nominal diameter  $d_1 = 20$  mm, upper tolerance limit = + (p) 25  $\mu\text{m}$  and lower tolerance limit = + (p) 15  $\mu\text{m}$ :

reamer 20 p 25 p 15 DIN ...

The designation shows a 'p' instead of the plus and an 'm' instead of the minus sign, because »+« and »-« cannot be written on all machines, particularly not on data processing machines.

## Tolerance position

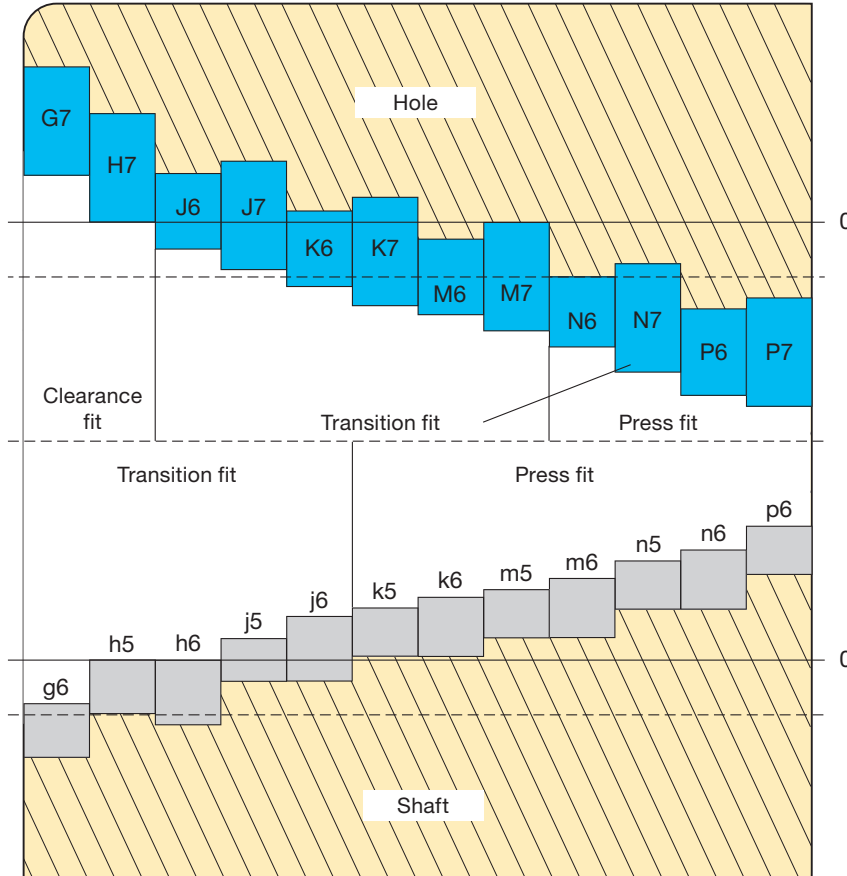

## Conversion ratio to DIN 47

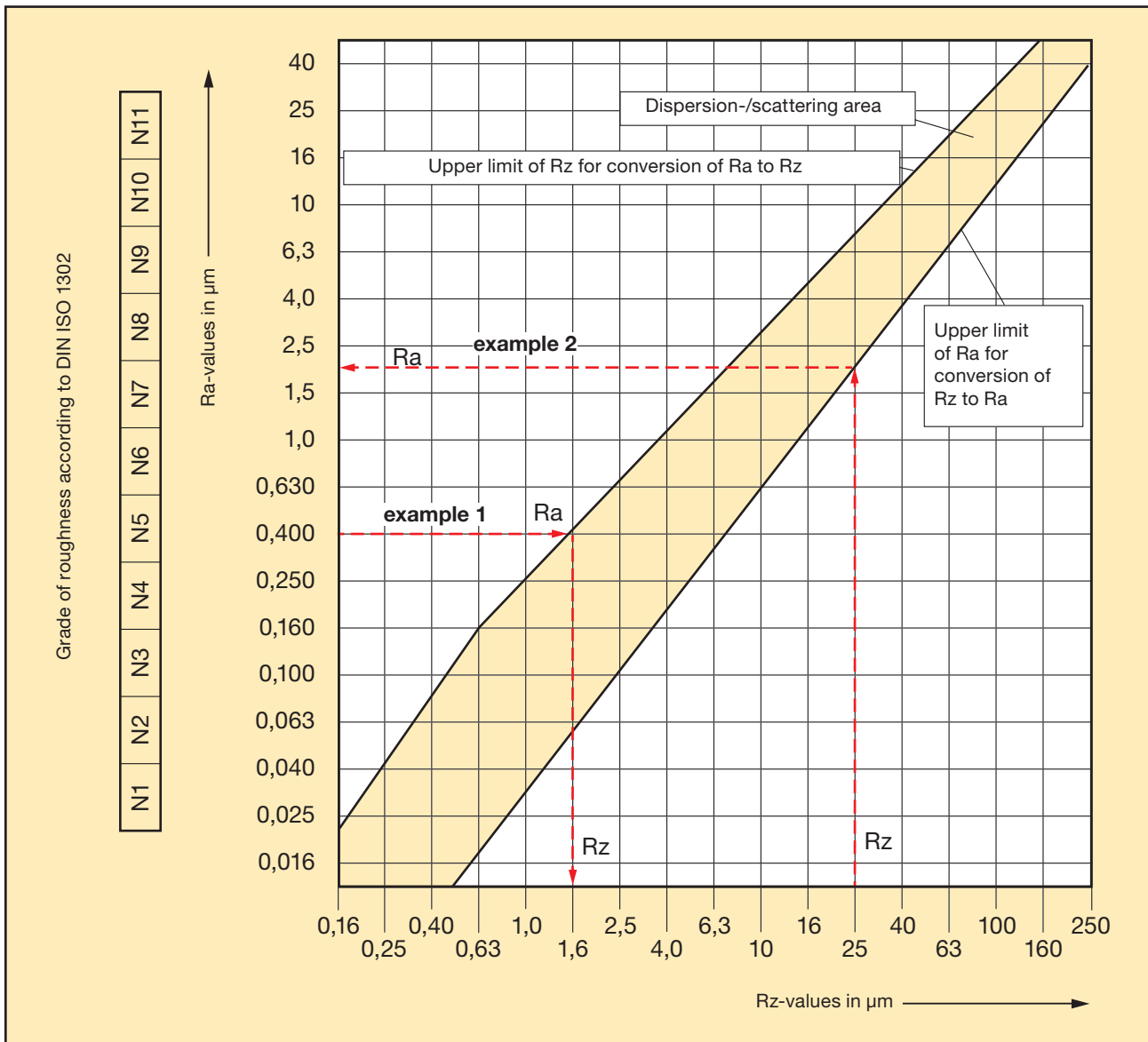

### Reading example: 1

When comparing the average roughness index  $R_a = 0.4 \mu\text{m}$  to the average roughness  $R_z$  we achieve a value of  $R_z = 1.6 \mu\text{m}$ .

### Reading example: 2

When comparing the average roughness  $R_z = 25 \mu\text{m}$  to the average roughness index  $R_a$  we achieve a value of  $R_a = 2 \mu\text{m}$ .

# Achievable surface quality for reaming operations

Roughness classes		N11	N10	N9	N8	N7	N6	N5	N4	N3	N2	N1		
Average roughness $R_a$		25	12.5	6.3	3.2	1.6	0.8	0.4	0.2	0.1	0.05	0.025		
Average peak-to-valley height $R_z$		100	63	40	25	16	10	6.3	4	2.5	1.6	1	0.63	0.25
P	Struct. steel, low-alloyed steels: Case-hard. and heat-treat. steels													
M	Stainless steels Heat-resistant steels													
K	Grey cast iron, ferritic													
	Grey cast iron, pearlitic													
	Spheroidal graphite iron, ferritic													
	Spheroidal graphite iron, pearlitic													
N	Copper-alloy, brass													
	Aluminium wrought alloy													
	Aluminium cast alloy: Si-content < 10 %													
	Aluminium cast alloy: Si-content > 10 %													
S	Special alloy: Inconel													
	Titanium, titanium alloys													
H	Hardened steel < 45 HRC													
	Hardened steel > 45 HRC, <= 63 HRC													

achievable

limited achievability

## Hardness comparison

Tens. strength (N/mm <sup>2</sup> )	HRC	HB30	HV10
240		71	75
255		76	80
270		81	85
285		86	90
305		90	95
320		95	100
335		100	105
350		105	110
370		109	115
385		114	120
400		119	125
415		124	130
430		128	135
450		133	140
465		138	145
480		143	150
495		147	155
510		152	160
530		157	165
545		162	170
560		166	175
575		171	180
595		176	185
610		181	190
625		185	195
640		190	200
660		195	205
675		199	210
690		204	215
705		209	220
720		214	225
740		219	230
755		223	235
770		228	240
785		233	245
800	22	238	250
820	23	242	255
835	24	247	260
860	25	255	268
870	26	258	272
900	27	266	280
920	28	273	287
940	29	278	293
970	30	287	302
995	31	295	310
1020	32	301	317
1050	33	311	327
1080	34	319	336
1110	35	328	345
1140	36	337	355
1170	37	346	364

Tens. strength (N/mm <sup>2</sup> )	HRC	HB30	HV10
1200	38	354	373
1230	39	363	382
1260	40	372	392
1300	41	383	403
1330	42	393	413
1360	43	402	423
1400	44	413	434
1440	45	424	446
1480	46	435	458
1530	47	449	473
1570	48	460	484
1620	49	472	497
1680	50	488	514
1730	51	501	527
1790	52	517	544
1845	53	532	560
1910	54	549	578
1980	55	567	596
2050	56	584	615
2140	57	607	639
2180	58	622	655
	59		675
	60		698
	61		720
	62		745
	63		773
	64		800
	65		829
	66		864
	67		900
	68		940

The reamer is the most commonly used tool for the production of holes true to form and tolerance with high surface quality. The latter meets the requirement of 'finishing' or 'fine finishing' i.e. from approximately Ra 0.2 to 6.5  $\mu\text{m}$  according to the scales laid down in DIN 4766. However, finishes to Ra = 0.5  $\mu\text{m}$  can be regarded as satisfactory. Generally, the achievable tolerance ranks at IT 7. In special cases IT 6 or even IT 5 are possible, provided that the reamer is appropriately ground and all other operating conditions meet the high specifications.

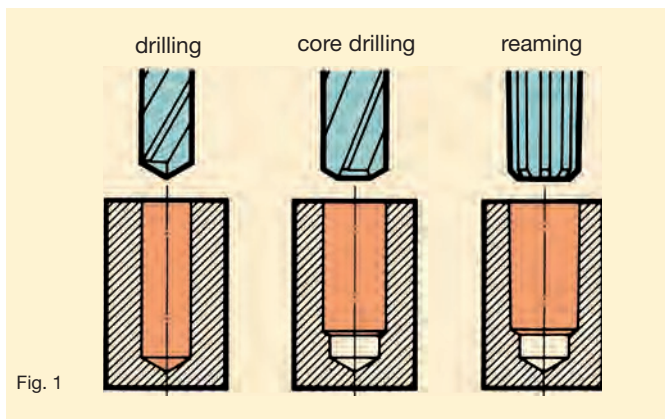

In preparation for the reaming process, holes have to be pre-drilled and normally core drilled (fig. 1). Pre-drilled holes produced with gun drills, are due to their highly compressed surface, not particularly suitable for reaming. Moreover, holes produced with gun drills show generally excellent tolerances on fit and surface qualities, so that additional fine finishing is usually not required. Should any further information on our gun drills be needed, please do not hesitate to contact us.

### Which reamer for which purpose?

With regard to their application we differentiate between:

- hand reamers
- machine reamers

### Hand reamers

Hand reamers are turned in the hole by means of a tap wrench which is mounted on the square. The feeding action is produced manually. Because of the low cutting rates these tools are made of HSS. To ensure a proper guidance in the hole the taper lead length of hand reamers is made considerably longer than that of machine reamers. Hand reamers are available for both cylindrical and tapered holes.

Hand reamers to DIN 859 may be adjusted within the elasticity tolerance range of hardened HSS. This corresponds in practice to 1% of the diameter, i.e. for example 0.1 mm on a reamer with 10 mm diameter. In the fully expanded condition these tools are not very resistant to breakage and must therefore be protected against impact. They should be stored with the tension released.

Expanding reamers can be adjusted over a much larger range, even up to a few millimeters! For accuracy reasons setting must be carried out with a ring gauge.

A basic rule for reaming by hand: turn the tool only in the cutting direction, i.e. never reverse the tool contrary to standard practice in thread cutting. Cutting edges will become immediately blunt if the reamer is turned back.



Fig. 2: taper hand reamer



Fig. 3: adjustable hand reamer



Fig. 4: expanding hand reamer with blades

### Machine reamers

Machine reamers are - as the name implies - exclusively designed for use on machines and differ with regard to the type of tool material. Due to the possibility of higher cutting values, these tools are available in HSS-E, solid carbide or carbide-tipped (fig. 5). The tool material should be selected in accordance with the material to be machined.



Fig. 5: carbide-tipped machine reamer

Carbide reamers offer the following advantages:

- Higher cutting speeds and feed rates.
- Most economic machining of materials of over 1200 mm<sup>2</sup> tensile strength.
- The tool life is much higher than that of HSS-E reamers.



### Reamers with special form

Reamers with special form and to special tolerances have recently become more and more common place. Their manufacture requires a great deal of know-how as well as the most modern and sophisticated tooling. We have all the machines and the knowledge to produce even the most complicated tools very economically. Leave the machining problems to us. To meet and overcome them is the daily task of our engineers. They are ready to assist you at all times, to find the best possible solution and, if necessary, to arrange for an obligation-free demonstration of our tools on your own machines.

A further distinctive feature of hand and machine reamers is the geometry of the cutting section, standardised under the following headings:

- straight-fluted reamers
- LH spiral reamers
- reamers with quick spiral (45°) left-hand flutes

Tools with right-hand spiral flutes are only applied in special cases. They produce, as do twist drills, a chip flow up the flutes, which often results in an unsatisfactory surface finish quality.

Reamers with straight flutes are suitable for the machining of blind holes. Here again the absence of chip space at the bottom of the hole means that swarf must be evacuated up the reamer flutes. For all other machining tasks, and particularly for interrupted holes (e.g. holes with keyways, intersecting holes and the like), reamers with left-hand spiral flutes are much more suitable. Chip removal is always in the direction of the feed and for this reason this flute geometry is used almost exclusively for through holes. Their application in blind holes is limited to tasks where reaming to the full depth is not required, so that sufficient space for the chip volume created is available.



Fig. 6: machine roughing reamer



Fig. 7: machine bottoming reamer

The 45° LH quick spiral reamer (fig. 6) has been well tried and tested in long-chipping materials. For absolutely straight and precisely located deep holes we recommend our machine bottoming reamers (fig. 7). Their bevel lead is face-cutting, i.e., they do not cut in conformity with the pre-drilled hole, but correct it truly to size. Machine bottoming reamers should always be applied with bushings.



Fig. 8: stepped carbide-tipped machine reamer

Accuracy in surface quality and form is tremendously improved by dividing the machining process into rough and finishing reaming. Stepped machine reamers (fig. 8) perform these two operations in one pass.

Badly worn taper pin reamers can be salvaged by resharpener of taper and reduction of circular land width.

### Storage of reamers

Reamers are finishing tools and therefore very vulnerable. To avoid damage, individual storage and transport in our plastic sleeves is recommended. Tools reward careful treatment by producing excellent results and giving much higher operational life.

## Blind hole or through hole

Straight-fluted reamers are generally applied in blind holes as they, due to their cutting edge geometry, evacuate the chips from the hole against the direction of the feed. Spiral reamers are preferred for the application in through holes because the spiral evacuates the chips from the hole in direction of the feed.

## Interrupted holes

Spiral reamers are preferred for the application in interrupted holes because the cutting edge geometry, in comparison to straight-fluted tools, possesses a lesser tendency of grabbing on the oblique hole. If the oblique hole is  $> 0.25 \times D$ , spiral reamers can also be applied in blind holes.

## Stock removal allowance of the pre-drilled hole

In the event of the stock removal allowance of the pre-drilled hole exceeding the standard stock removal allowance (see table „Recommended stock allowance“ on page 15), a quick spiral reamer or a machine bridge reamer should be applied. It is possible to machine a considerably larger stock removal allowance with these tools, however, they should not be applied in blind holes due to the bevel lead length and the spiral angle.

## Expanding reamers

Expanding reamers can only be expanded. Subsequently, if the resulting measurement is too large it is not possible to turn the screw back as the pretension of the tool would be lost. In most cases this leads to tool breakage. If the pre-tension has been taken from the tool, it requires re-adjusting and re-grinding.

## Positional accuracy of the hole

A machine bottoming reamer often provides the best solution when optimal positional accuracy is required, thanks to its special chamfer lead the ‘wander’ of the tool is minimal. In addition, machine bottoming reamers are often applied when the pre-drilled hole and the reamer are not on the same axis (slight misalignment).

Schematic depiction of expanding and of risk of tool breakage when re-turning set screw (excessive depiction)

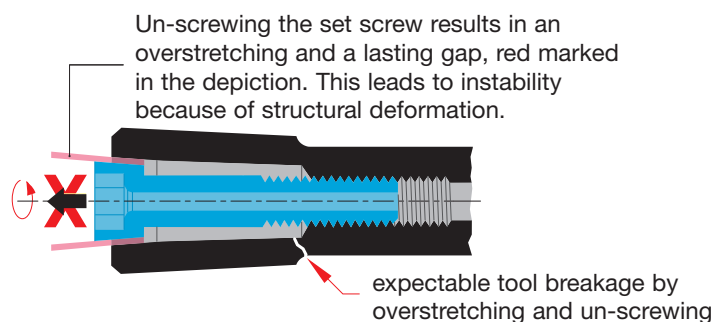
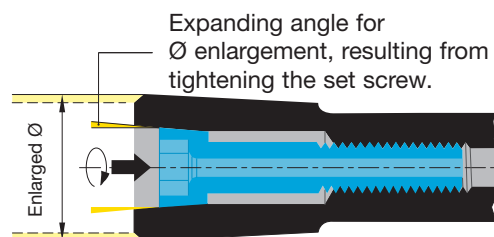
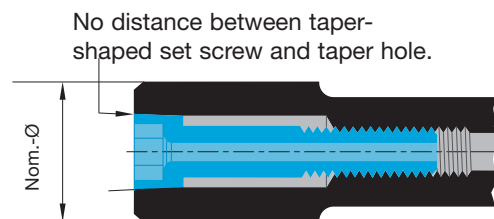

### Carbide reamer designs

Our carbide grades are applied in the following reamer types:

- Solid carbide NC machine reamers:  
Solid carbide
- Carbide machine reamers:  
≤ Ø 9.50 mm solid carbide  
> Ø 9.50 mm carbide tipped
- Carbide expanding machine reamers:  
Carbide tipped

### Expanding Reamers Adjustment range

Expanding reamers can be adjusted by the following values according to the diameter range:

- ≥ Ø 12 mm by approx. 0.015 mm
- ≥ Ø 17 mm by approx. 0.020 mm
- ≥ Ø 24 mm by approx. 0.025 mm
- ≥ Ø 32 mm by approx. 0.030 mm

#### Attention:

Only expand reamer! Because of risk of breakage the pre-tension should never be relieved by turning the set screw anti-clockwise!

### Expanding reamers Adjustment range

Expanding reamers have an adjustment range of approx. 0.03 mm via a tapered adjustment screw.

### Adjustable hand reamers Adjustment range

Adjustable hand reamers are ground to nominal size and not for holes with tolerance zone H7. The adjustment range is 1/100 of the nominal diameter, i.e. for Ø 10.00 mm approximately 0.1 mm. From Ø 6.50 mm adjustment is via lock nut.

### Shell reamers Taper bore

Shell reamers to DIN 219 have a taper bore with a taper 1:30 and a driving slot to DIN 138.

## Definitions, dimensions and angles

### Reamers

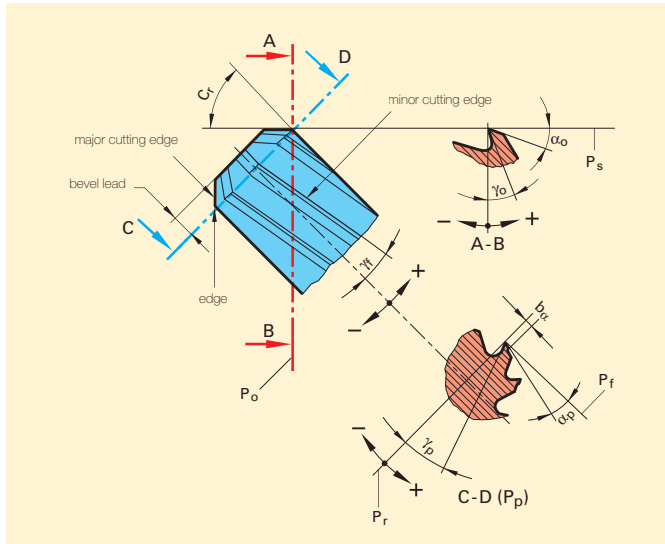

### Counterbores

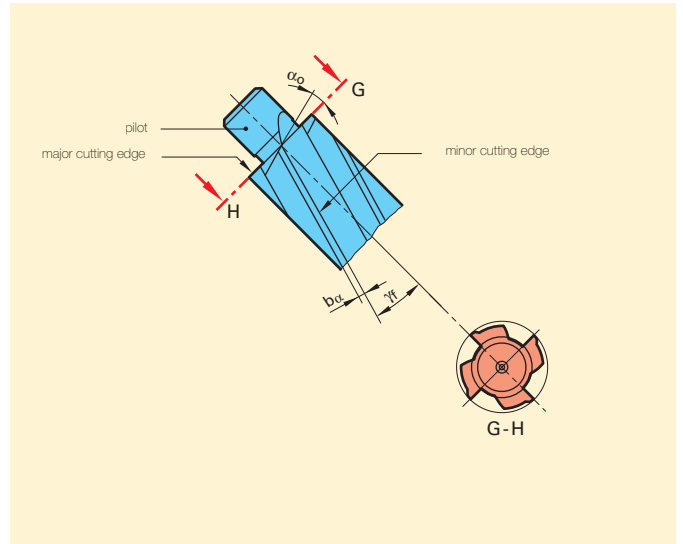

### Countersinks

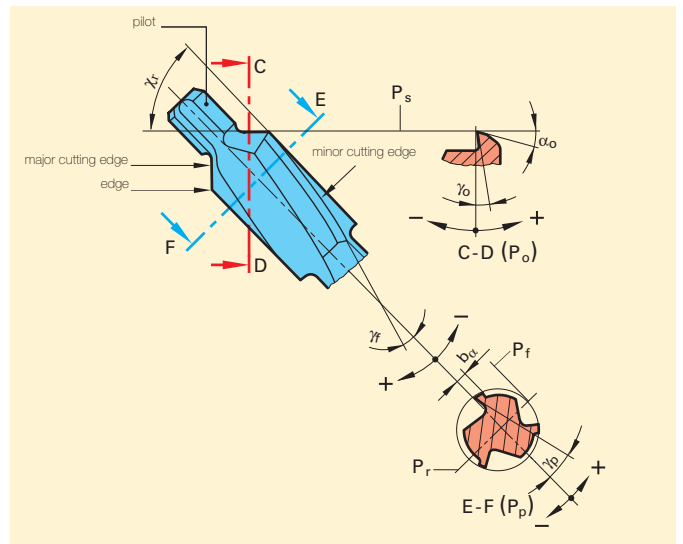
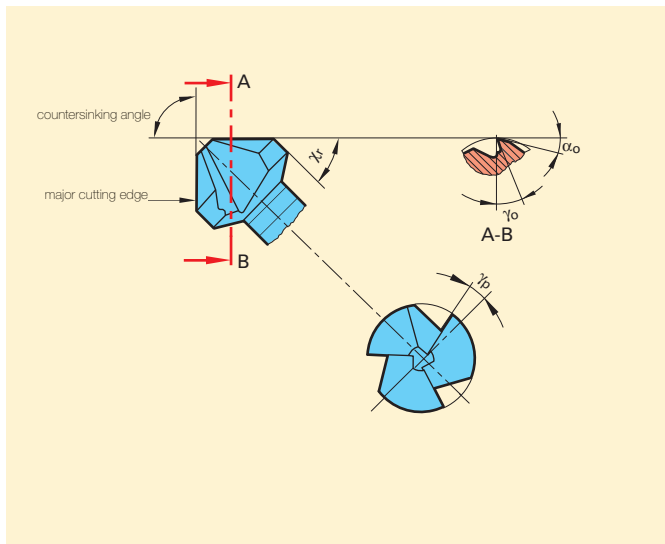

$\alpha_o$  = clearance angle  
 $\alpha_p$  = clearance angle of minor cutting edge  
 $b_{\square}$  = circular land width  
 $\gamma_o$  = orthogonal rake angle  
 $\gamma_f$  = helix angle  
 $\gamma_p$  = back rake angle of minor cutting edge

$\chi_r$  = face setting angle  
 $P_o$  = tool orthogonal plane  
 $P_f$  = assumed operating plane  
 $P_p$  = tool back plane  
 $P_r$  = tool reference plane  
 $P_s$  = tool cutting edge plane



# PRODUCT NO. INDEX

# Product no. index

Guhring no.	Standard range page	Discount group	Standard	Description	Tool material	Type	Form
324	150	105	373	Counterbores with fixed pilots for fine tolerances	HSS		
325	152	105	373	Counterbores with fixed pilots for medial tolerances	HSS		
326	154	105	373	Counterbores with fixed pilots for tapping size holes	HSS		
327	139	105	335	90° countersinks	HSS		C
328	140	105	335	90° countersinks	HSS		D
401	59	105	212	Machine reamers	HSS-E		A
402	59	105	212	Machine reamers	HSS-E		B
403	71	105	212-1	Quick spiral reamers	HSS-E		C
404	64	105	208	Machine reamers	HSS-E		A
405	64	105	208	Machine reamers	HSS-E		B
406	73	105	208	Quick spiral reamers	HSS-E		C
407	78	105	219	Shell reamers	HSS-E		A
408	78	105	219	Shell reamers	HSS-E		B
409	79	105	219	Shell reamers	HSS-E		C
410	87	105	2179	Machine taper reamers	HSS-E		
411	88	105	2180	Machine taper reamers	HSS-E		
412	93	105	206	Hand reamers	HSS		A
413	93	105	206	Hand reamers	HSS		B
414	74	105	311	Machine bridge reamers	HSS		
415	95	105	859	Adjustable hand reamers	HSS		B
416	97	105	G.S.	Expanding hand reamers	HSS		
417	98	105	G.S.	Replacement blades for expanding hand reamers	HSS		
419	75	105	G.S.	Machine bottoming reamers	HSS-E		A
420	76	105	G.S.	Machine bottoming reamers	HSS-E		A
428	89	105	9	Hand taper reamers	HSS		A
429	89	105	9	Hand taper reamers	HSS		B
431	77	105	G.S.	Stepped machine reamers	HSS-E		
432	160	105	1862	Spot facers	HSS-E		
433	161	105	1862	Spot facers	HSS-E		
434	162	105	1862	Spot facers	HSS-E		
435	163	105	1862	Spot facers	HSS-E		
436	143	105	1866	90° countersinks for fine tolerances	HSS		
437	144	105	1866	90° countersinks for medial tolerances	HSS		
438	145	105	1866	90° countersinks for tapping size holes	HSS		
440	60	105	212-2	Machine reamers	HSS-E		A
455	54	105	212-3	NC machine reamers	HSS-E		B
457	59	105	212	Machine reamers	HSS-E		A
458	70	105	8089	Machine reamer sets	HSS-E		B
463	156	105	375	Counterbores with hole for detachable pilot	HSS		
464	157	105	1868	Detachable pilot for fine tolerances	HSS		
465	158	105	1868	Detachable pilot for medial tolerances	HSS		
466	159	105	1868	Detachable pilot for tapping size holes	HSS		
467	60	105	212-2	Machine reamers	HSS-E		A
468	60	105	212-2	Machine reamers	HSS-E		B
469	71	105	212-2	Quick spiral reamers	HSS-E		C
470	135	105	334	60° countersinks	HSS		A
471	137	105	334	60° countersinks	HSS		B
472	134	105	334	60° countersinks	HSS		C
473	136	105	334	60° countersinks	HSS		D
474	138	105	335	90° countersinks	HSS		A
475	141	105	335	90° countersinks	HSS		B
476	139	105	335	90° countersinks	HSS		C
477	140	105	335	90° countersinks	HSS		D
478	146	105	347	120° countersinks	HSS		A
479	149	105	347	120° countersinks	HSS		B
480	147	105	G.S.	120° countersinks	HSS		
481	148	105	G.S.	120° countersinks	HSS		
482	150	105	373	Counterbores with fixed pilots for fine tolerances	HSS		
483	152	105	373	Counterbores with fixed pilots for medial tolerances	HSS		
484	154	105	373	Counterbores with fixed pilots for tapping size holes	HSS		
485	151	105	G.S.	Counterbores with fixed pilots for fine tolerances	HSS		
486	153	105	G.S.	Counterbores with fixed pilots for medial tolerances	HSS		
487	155	105	G.S.	Counterbores with fixed pilots for tapping size holes	HSS		
488	68	105	8089	Machine reamers	HSS-E		A
489	68	105	8089	Machine reamers	HSS-E		B
490	54	105	212-3	NC machine reamers	HSS-E		B
495	168	120	G.S.	Front/back deburrer 90°	Solid carbide	EW 100 VR	
496	62	105	212	Machine reamers	HSS-E		B
497	69	105	8089	Machine reamers	HSS-E		B
498	142	105	335	90° countersinks	HSS		C
499	142	105	335	90° countersinks	HSS		C
641	60	105	212-2	Machine reamers	HSS-E		B
642	64	105	208	Machine reamers	HSS-E		B
674	44	120	~8090	Machine reamers	Carbide		A
717	39	120	~8050	Machine reamers	Carbide		A
718	39	120	~8050	Machine reamers	Carbide		B
719	42	120	~8051	Machine reamers	Carbide		A
720	42	120	~8051	Machine reamers	Carbide		B

# Product no. index

Guhring no.	Standard range page	Discount group	Standard	Description	Tool material	Type	Form
727	48	120	8054	Shell reamers	Carbide		
737	44	120	~8090	Machine reamers	Carbide		C
740	46	120	G.S.	Expanding machine reamers	Carbide		A
743	47	120	G.S.	Stepped machine reamers	Carbide		
749	45	120	G.S.	Expanding machine reamers	Carbide		A
1036	20	166	G.S.	Carbide high performance reamers	Solid carbide		
1037	20	166	G.S.	Carbide high performance reamers	Solid carbide		
1038	25	166	G.S.	Carbide high performance reamers	Solid carbide		
1039	26	166	G.S.	Carbide high performance reamers	Solid carbide		
1040	25	166	G.S.	Cermet high performance reamers	Cermet tipped		
1041	26	166	G.S.	Cermet high performance reamers	Cermet tipped		
1326	139	105	335	90° countersinks	HSS		C
1407	44	120	~8090	Machine reamers	Carbide		B
1408	40	120	~8093	Machine reamers	Carbide		A
1409	40	120	~8093	Machine reamers	Carbide		B
1410	43	120	~8094	Machine reamers	Carbide		A
1411	43	120	~8094	Machine reamers	Carbide		B
1427	34	120	G.S.	NC machine reamers	Solid carbide		B
1428	40	120	~8093	Machine reamers	Carbide		A
1429	40	120	~8093	Machine reamers	Carbide		B
1430	44	120	~8090	Machine reamers	Carbide		A
1431	66	105	212-2	Machine reamers with coolant duct	HSS-E		A
1432	67	105	8089	Machine reamers with coolant duct	HSS-E		A
1433	90	105	G.S.	Hand taper reamers	HSS		
1434	81	105	G.S.	Arbors without accessories			
1435	83	105	G.S.	Draw-off nuts			
1436	84	105	G.S.	Driving collars			
1437	82	105	6888	Woodruff keys			
1438	80	105	217	Arbors, complete			
1449	34	120	G.S.	NC machine reamers	Solid carbide		B
1675	14	166	G.S.	Carbide high performance reamers	Solid carbide	HR 500 S	
1676	17	166	G.S.	Carbide high performance reamers	Solid carbide	HR 500 D	
1678	21	166	G.S.	Carbide high performance reamers	Solid carbide		
1679	21	166	G.S.	Carbide high performance reamers	Solid carbide		
1680	22	166	G.S.	Carbide high performance reamers	Carbide	HR 500 GS	
1681	23	166	G.S.	Carbide high performance reamers	Carbide	HR 500 GD	
1682	22	166	G.S.	Cermet high performance reamers	Cermet tipped	HR 500 GS	
1683	23	166	G.S.	Cermet high performance reamers	Cermet tipped	HR 500 GD	
1685	14	166	G.S.	Carbide high performance reamers	Solid carbide	HR 500 S	
1686	17	166	G.S.	Carbide high performance reamers	Solid carbide	HR 500 D	
4095	127	Net price	G.S.	Reduction sleeves for floating holders			
4096	127	Net price	G.S.	Reduction sleeves for short floating holders			
4097	128	Net price	G.S.	Reduction sleeves for mini floating holders			
4098	125	Net price	G.S.	Floating holder with ER collet holder			
4100	166	Net price	G.S.	De-burring forks	Solid carbide	EW 100 G	
4101	165	Net price	G.S.	De-burring forks	Solid carbide	EW 100 G	
4116	126	Net price	G.S.	Floating ER Collet holder VDI DIN 69880-1			
4117	126	Net price	G.S.	Floating side lock holder VDI DIN 69880-1			
4167	124	Net price	G.S.	Floating side lock holder			
4169	124	Net price	G.S.	Floating, short side lock holder			
4174	125	Net price	G.S.	Floating, mini side lock holder			
4175	128	114	G.S.	Collet holder ER metallic sealed			
4290	27	114	G.S.	HSK-A hydraulic chucks, overlength			
4297	118	114	G.S.	Modul 4x4 HSK-A alignment adaptor			
4360	119	114	G.S.	Modul 4x4 hydraulic chuck flange			
4363	117	114	G.S.	Modul 6x6 HSK adaptor flange			
4713	121	114	G.S.	Modul 4x4 HSK adaptor flange			
4714	117	114	G.S.	Modul 6x6 HPC clamping chuck flange			
4715	122	114	G.S.	Angle alignment units f. mod. flange/alignment adapter 6x6/4x4			
4716	122	114	G.S.	Intermediate sleeves f. mod. flange/alignment adapter 6x6/4x4			
4717	116	114	G.S.	Modul 6x6 shrink fit chuck flange			
4722	115	114	G.S.	Modul 6x6 hydraulic chuck flange			
4723	113	114	G.S.	Module 6x6 HSK-A alignment adapter			
4724	118	114	G.S.	Modul 4x4 ISO taper alignment adaptor			
4725	114	114	G.S.	Modul 6x6 ISO taper alignment adapter			
4760	120	114	G.S.	Modul 4x4 shrink fit chuck flange			
4941	121	114	G.S.	Length adjustment screw for conventional cooling			
20023	102			Fineboring tools			
20024	103			Fineboring tools			
20102/20112	104			Inserts		W 1035-...	
20145/20155	104			Inserts		W 2850-...	
20178	104			Inserts		W 3570-...	
20194	105			Inserts		W 4090-...	
20208	105			Inserts		W 3573-...	
20212	105			Inserts		W 4093-...	
20400/20402	104			Inserts		W 1035-...	
20430/20432	104			Inserts		W 2850-...	
20450/20452	104			Inserts		W 3570-...	
20460/20462	105			Inserts		W 4090-...	

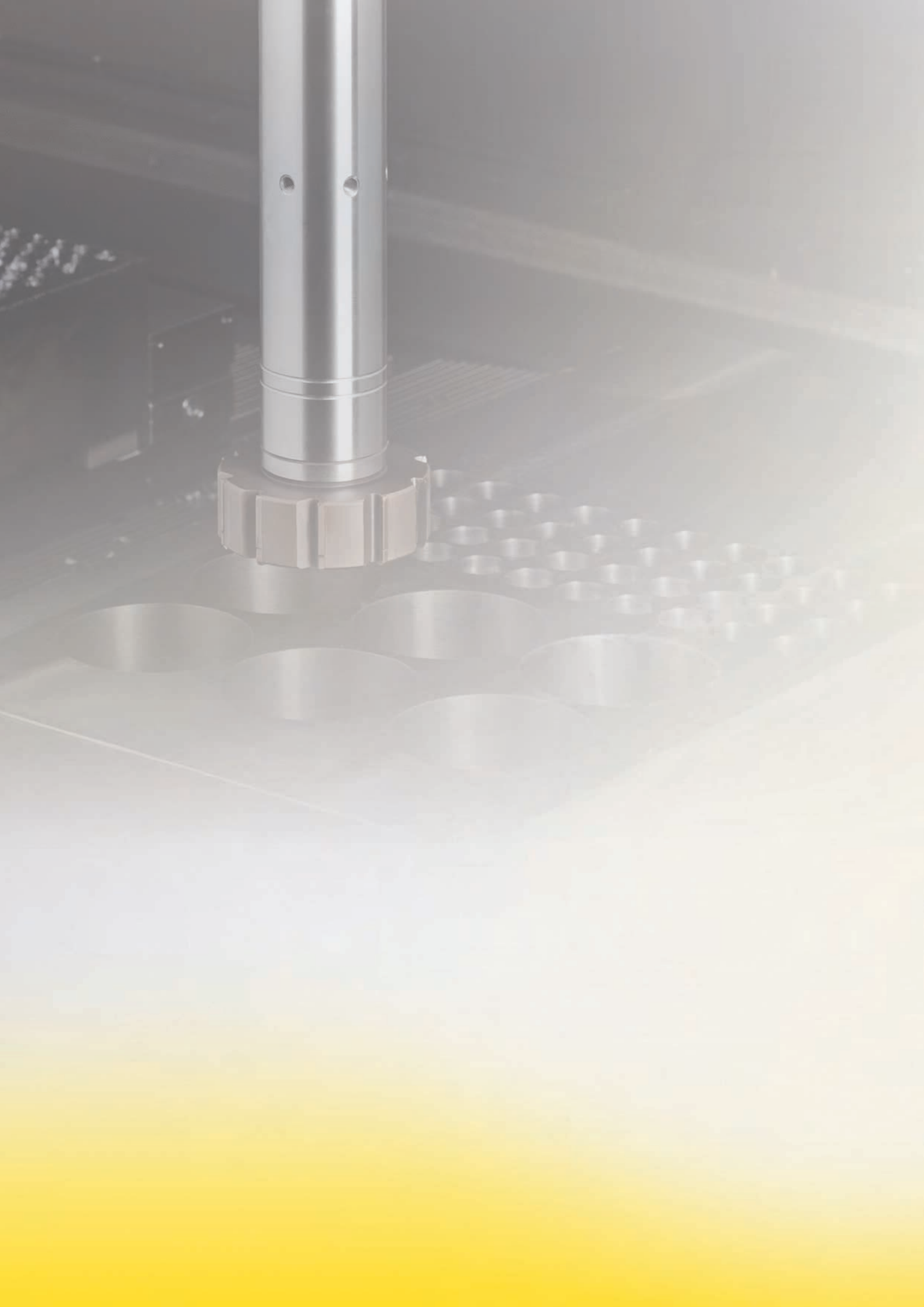





# GUHRING



**GUHRING KG**  
Herderstrasse 50 - 54  
72458 Albstadt  
Germany

Tel.: +49 74 31 17 - 0  
Fax: +49 74 31 17 - 21 279  
info@guehring.de  
www.guehring.de