

# GUHRING

PRICELIST 42/2012

For extreme process reliability

From hole diameter 11 to 40.0 mm

For drilling depths 1.5xD, 3xD, 5xD, 7xD and 10xD

With interchangeable inserts for steel, stainless steel, cast iron and Al

Holder/interchangeable inserts for pilot drilling/countersinking

# HT 800



## HT 800 WP

The interchangeable insert drilling system

GUHRING - YOUR WORLD-WIDE PARTNER

# HT 800 WP and power engineering

The ideal drilling system for the production of large, highly-accurate holes in a variety of materials for wind and water power stations, engine plants or gas/steam turbines

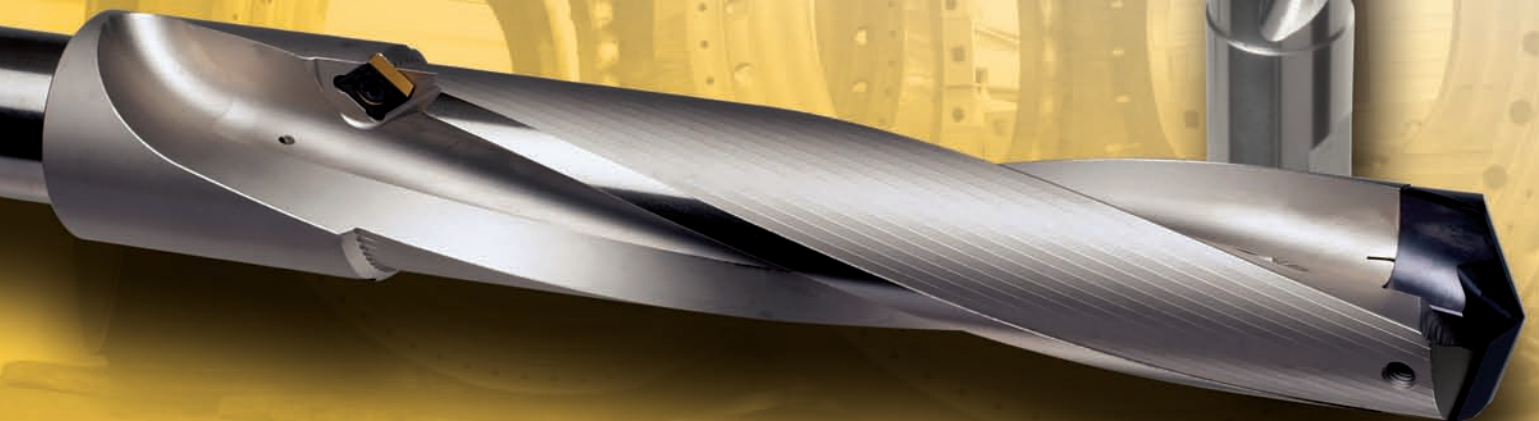
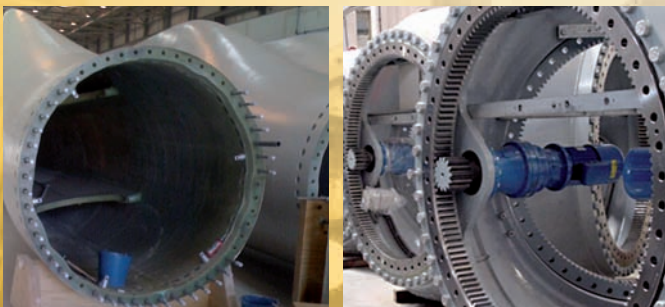

<b>INSERTS</b>	• Technical features	Page	5
	• Application recommendations	Page	6
	• Notes regarding application	Page	6
	• Program and prices	Page	8

<b>INSERT HOLDERS</b>	• Technical features	Page	5
	• Selected machining results	Page	7
	• Program and prices	Page	16

<b>ACCESSORIES</b>	• Program and prices	Page	30
--------------------	----------------------	------	----

<b>GÜHRINGNAVIGATOR</b>	• up to drilling depth 1 x D	Page	32
	• up to drilling depth 1.5 x D	Page	34
	• up to drilling depth 3 x D	Page	36
	• up to drilling depth 5 x D	Page	38
	• up to drilling depth 7 x D	Page	40
	• up to drilling depth 10 x D	Page	42

<b>TROUBLESHOOTING</b>	Page	44
------------------------	------	----

<b>QUESTIONNAIRE SPECIAL TOOLS</b>	Page	47
--	------	----

With the new HT 800 WP interchangeable drilling system Guhring provides high-performance and cost-efficient holders for holes in the diameter range from 11.00 to 40.0 mm that excell thanks to the following advantages:

**A Extended tool life**

Thanks to special, micro-machined cutting edges and the application oriented surface finish the interchangeable inserts of the HT 800 WP drilling system are especially wear resistant.

The holders of the HT 800 WP drilling system also possess a very high wear resistance. This is based on the optimised holder material with nickel plated surface as well as incremental holder sizes in steps of 0.5 mm up to diameter 31.99 mm and in steps of 1.0 mm above diameter 32.00 mm. This leads to less wear on the holder body.

**B Optimised chip flow**

Thanks to their flute cross section the holders of the HT 800 WP drilling system ensure optimal chip evacuation from the hole even with larger drilling depths.

**C Perfect cooling lubrication**

A perfect cooling lubrication is ensured by coolant ducts with maximum cross section, exiting in the flute. Thereby enabling an optimal cooling lubrication of the cutting edges and additionally support the chip evacuation from the hole.

**D Highly accurate and rigid insert seat**

The accurate insert seat enables the insert change in the machine in only a few, simple steps with a standard Torx screw driver. Thanks to the optimised material for the holders of the HT 800 WP drilling system, the insert can be changed more frequently than with conventional systems before the holder needs to be replaced due to wear of the insert seat.

The clamping screws with screw lock ensure a secure holding of the interchangeable insert in the holder even with machines subject to high levels of vibrations.

**Rigid holders**

The close stepped diameter jumps with the holder sizes not only reduce wear. Through the better guidance of the tool in the hole they also increase the rigidity of the HT 800 WP drilling system. Subsequently, resulting in longer tool life as well as improved workpiece surfaces.

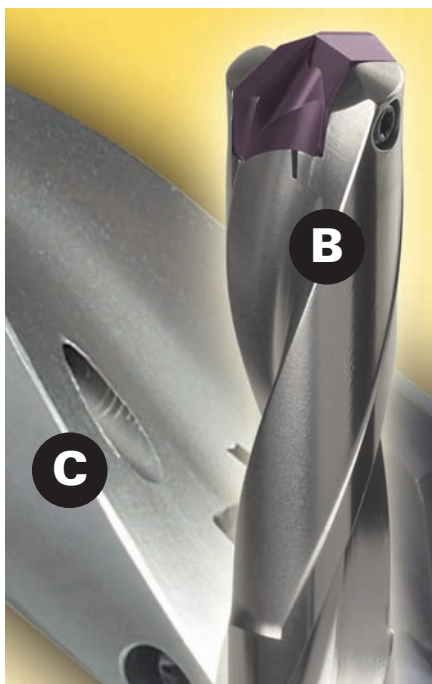

## HT 800 WP - Application Tips

Please observe the following notes and recommendations for the application of Guhring's HT 800 WP tools:

We recommend when changing the insert to also replace the clamping screw!

Therefore, every holder is supplied with a clamping screw, Guhring no. 4071, and screwdriver, Guhring no. 1612. Every interchangeable insert is also supplied with a clamping screw, Guhring no. 4071.

When changing the insert please observe the following tightening torques for the clamping screw. Adhering to them is absolutely necessary for optimal machining results!

Diameter range	11.0 - 12.99	13.0 - 13.99	14.0 - 15.99	16.0 - 17.99	18.0 - 19.99	20.0 - 21.99	22.0 - 25.99	30.0 - 40.00
Thread	M2.2	M2.5	M3	M3.5	M4	M4.5	M5	M6
Torx size	T7	T8	T9	T10	T15	T15	T20	T25
Tightening torque [Nm]	0.80	1.00	1.70	2.70	4.00	6.0	8.00	14.0

Details apply to thread locking (Loctite)!

## Selected machining results

Guhring no.	4107 + 4112	4109 + 4112	4109 + 4112	4107 + 4113	4108 + 4113
Diameter	175	175	175	175	14.1
Coating	nanoFIRE	nanoFIRE	nanoFIRE	FIRE	FIRE
Material group	alloyed heat-treatable steel	alloyed heat-treatable steel	general structural steels	cast iron	cast iron
Material description	42CrMo4/ 1.7275	42CrMo4/ 1.7275	St52-3/ 1.0570	GG25/ 0.6025	GGG40/ 0.7040
Drill. depth [mm]	50	122,5	122,5	50	70
Hole type	blind hole	blind hole	blind hole	blind hole	blind hole
Cooling	IC 40 bar	IC 40 bar	IC 40 bar	IC 40 bar	IC 55 bar
Coolant	soluble oil	soluble oil	soluble oil	soluble oil	soluble oil
Machine type	machining centre	machining centre	machining centre	machining centre	machining centre
$v_c$ [m/min]	100	85	130	80	160
$f_z$ [mm]	0,28	0,25	0,15	0,30	0,60
Tool life [m]	50	30	35	250	120







HT 800 WP interchangeable inserts are in respect of tool material, geometry and surface finish perfectly adapted to your specific range of application. Subsequently, you will always achieve optimal machining results with maximum performance and highest economic efficiency. The insert change with HT 800 WP can be performed in the machine problem-free, the interchangeable insert always sits perfectly clamped and positioned in the holder. From diameter 26.00 up to 40.00 mm regrinding of inserts is possible.

## Technical features and application recommendations

Guhring no.	4112	4115	4113	4114	4111
Tool material	solid carbide	solid carbide	solid carbide	solid carbide	solid carbide
Surface	nanoFIRE	nanoA	FIRE	bright	nanoA
Point geometry	2-facet	relieved cone	2-facet	relieved cone	2-facet
Point angle	140°	140°	140°	140°	145°
Tolerance	h7	h7	m7	h7	m7
Diameter	11.0 - 40.0	11.0 - 40.0	11.0 - 40.0	11.0 - 40.0	11.0 - 40.0
Application	steel	stainl. steel	cast iron	aluminium	pilot drilling

- optimal suitability
- limited suitability

Application group	Material examples					
<b>P</b>	steel, cast steel, stainless steel (ferritic and martensitic)	●	○	○		○
<b>M</b>	stainless steel and cast steel (austenitic and austenitic/ferritic)	○	●			○
<b>K</b>	grey cast iron, spheroidal graphite und malleable cast iron	○		●		○
<b>N</b>	aluminium and other non-ferrous metals				●	○
<b>S</b>	Special, Super- and Ti-alloys		○			○
<b>H</b>	Hardened steels and chilled cast iron		○			○



## Complete compatibility

The new interchangeable inserts as well as the new holders of the HT 800 WP system are fully compatible with the conventional HT 800 WP interchangeable inserts and holders. You can, therefore, apply the new interchangeable inserts in the already existing HT 800 WP holders or combine new holders with existing interchangeable inserts. Drilling tests with both combination possibilities have shown that the efficiency of each package lies above the values of the old HT 800 WP system. You will definitely benefit!

The pilot insert 4111 can be combined with any holder, if the application requires a 145° point angle.







Guhring no.	7645	7632	7635
Tool material	solid carbide	solid carbide	solid carbide
Surface	TiN	TiAlN	bright
Type	CPGT ... R	CPGW ...	CPGT ... R
Application	steel	cast iron	aluminium

- optimal suitability
- limited suitability

Application group	Material examples			
<b>P</b>	steel, cast steel, stainless steel (ferritic and martensitic)	●	○	
<b>M</b>	stainless steel and cast steel (austenitic and austenitic/ferritic)	○		
<b>K</b>	grey cast iron, spheroidal graphite und malleable cast iron	○	●	
<b>N</b>	aluminium and other non-ferrous metals			●
<b>S</b>	Special, Super- and Ti-alloys	○		
<b>H</b>	Hardened steels and chilled cast iron	○		

## HT 800 WP Interchangeable Insert Holders

HT 800 WP holders offer highest accuracy and rigidity. The open flute together with internal cooling guarantees an optimal chip evacuation particularly from deeper holes. The reinforced shank to DIN 6535 HE ensures the strong and accurate clamping of the holder in the tool holder. As it meets the DIN standard for solid carbide monoblock tools, a problem-free changeover to the HT 800 WP system in production is possible at any time.



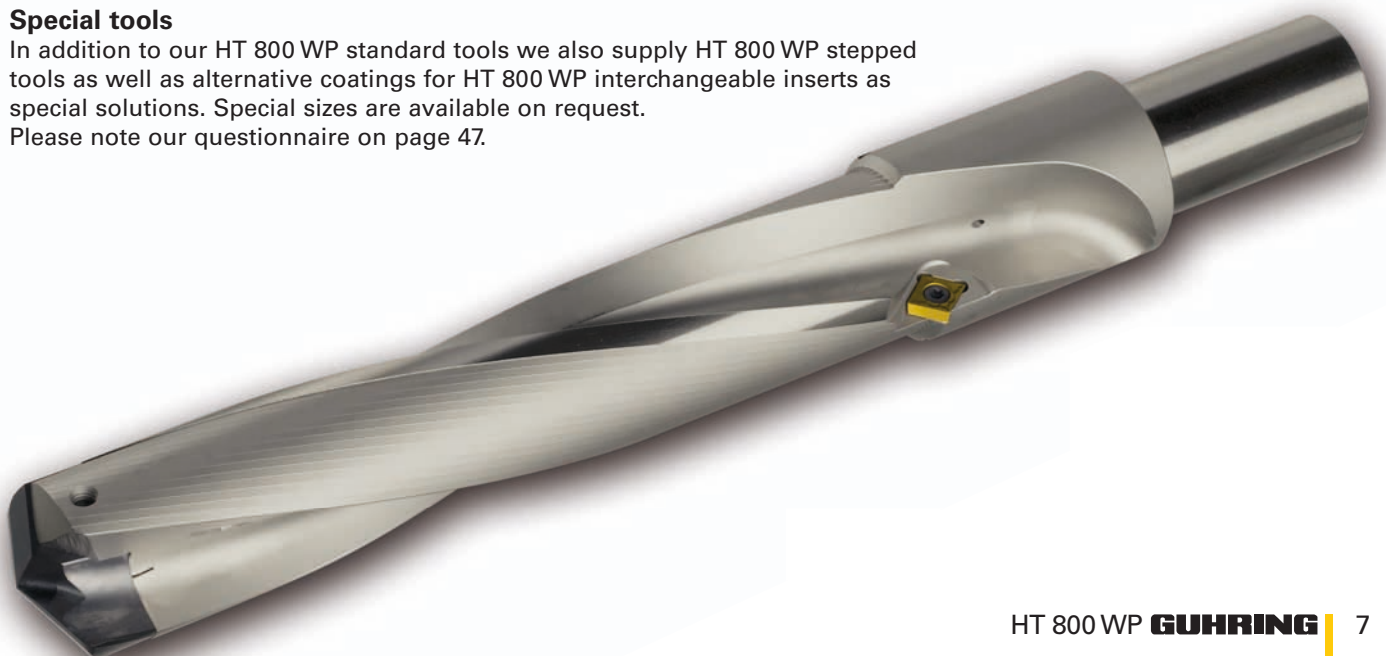

Guhring no.	4105	4106	4107	4108	4109	4110
Drilling depth	1 x D	1.5 x D	3 x D	5 x D	7 x D	10 x D
Diameter	11.0 - 40.00	11.0 - 40.00	11.0 - 40.00	11.0 - 40.00	11.0 - 31.99	11.0 - 31.99
Shank	DIN 6535-HE	DIN 6535-HE	DIN 6535-HE	DIN 6535-HE	DIN 6535-HE	DIN 6535-HE
45° pilot drilling/ countersinking						

### Special tools

In addition to our HT 800 WP standard tools we also supply HT 800 WP stepped tools as well as alternative coatings for HT 800 WP interchangeable inserts as special solutions. Special sizes are available on request. Please note our questionnaire on page 47.

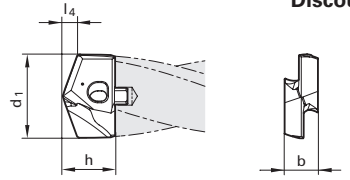



# HT 800 WP Interchangeable Inserts For Machining Steel

Order no. = Guhring no. + Code-no. 								Guhring no			
								DIN			
								Tool material			
								P M K N S H			
								Surface finish			
Discount group								4112	4115	4113	4114
Tolerance								Guhring std.	Guhring std.	Guhring std.	Guhring std.
								Solid carbide	Solid carbide	Solid carbide	Solid carbide
								●	○	○	
								○	●		
								○		●	
											●
									○		
									○		
								nanoFIRE	TiAlN nanoA	FIRE	bright
								141	141	141	141
								h7	h7	m7	h7
											
								Availability	Availability	Availability	Availability
11,000	110	110		11.00	2.10	4.50	7.50	●	●	●	●
11,200	110	110		11.20	2.10	4.50	7.50	●	●	●	●
11,500	115	110		11.50	2.10	4.50	7.50	●	●	●	●
11,510	115	110	29/64	11.51	2.10	4.50	7.50	●	●	●	●
11,700	115	110		11.70	2.10	4.50	7.50	●	●	●	●
11,800	115	110		11.80	2.10	4.50	7.50	●	●	●	●
11,910	115	110	15/32	11.91	2.20	4.50	7.50	●	●	●	●
12,000	120	120		12.00	2.20	5.00	7.70	●	●	●	●
12,100	120	120		12.10	2.20	5.00	7.70	●	●	●	●
12,200	120	120		12.20	2.20	5.00	7.70	●	●	●	●
12,300	120	120	31/64	12.30	2.20	5.00	7.70	●	●	●	●
12,500	125	120		12.50	2.30	5.00	7.70	●	●	●	●
12,600	125	120		12.60	2.30	5.00	7.70	●	●	●	●
12,700	125	120	1/2	12.70	2.30	5.00	7.70	●	●	●	●
12,800	125	120		12.80	2.30	5.00	7.70	●	●	●	●
12,900	125	120		12.90	2.30	5.00	7.70	●	●	●	●
13,000	130	130		13.00	2.40	5.50	8.50	●	●	●	●
13,100	130	130	33/64	13.10	2.40	5.50	8.50	●	●	●	●
13,490	130	130	17/32	13.49	2.40	5.50	8.50	●	●	●	●
13,500	135	130		13.50	2.40	5.50	8.50	●	●	●	●
13,600	135	130		13.60	2.40	5.50	8.50	●	●	●	●
13,700	135	130		13.70	2.40	5.50	8.50	●	●	●	●
13,800	135	130		13.80	2.50	5.50	8.50	●	●	●	●
13,890	135	130	35/64	13.89	2.50	5.50	8.50	●	●	●	●
14,000	140	140		14.00	2.50	6.00	9.60	●	●	●	●
14,100	140	140		14.10	2.50	6.00	9.60	●	●	●	●
14,290	140	140	9/16	14.29	2.60	6.00	9.60	●	●	●	●
14,400	140	140		14.40	2.60	6.00	9.60	●	●	●	●
14,500	145	140		14.50	2.60	6.00	9.60	●	●	●	●
14,600	145	140		14.60	2.70	6.00	9.60	●	●	●	●
14,680	145	140	37/64	14.68	2.70	6.00	9.60	●	●	●	●
14,700	145	140		14.70	2.70	6.00	9.60	●	●	●	●
14,800	145	140		14.80	2.70	6.00	9.60	●	●	●	●
15,000	150	140		15.00	2.70	6.00	9.80	●	●	●	●
15,080	150	140	19/32	15.08	2.70	6.00	9.80	●	●	●	●
15,100	150	140		15.10	2.70	6.00	9.80	●	●	●	●
15,200	150	140		15.20	2.80	6.00	9.80	●	●	●	●
15,300	150	140		15.30	2.80	6.00	9.80	●	●	●	●
15,480	150	140	39/64	15.48	2.80	6.00	9.80	●	●	●	●
15,500	155	140		15.50	2.80	6.00	9.80	●	●	●	●
15,600	155	140		15.60	2.90	6.00	9.80	●	●	●	●
15,700	155	140		15.70	2.90	6.00	9.80	●	●	●	●
15,800	155	140		15.80	2.90	6.00	9.80	●	●	●	●
15,870	155	140	5/8	15.87	2.90	6.00	9.80	●	●	●	●
16,000	160	160		16.00	2.90	7.00	11.00	●	●	●	●
16,270	160	160	41/64	16.27	3.00	7.00	11.00	●	●	●	●
16,500	165	160		16.50	3.00	7.00	11.00	●	●	●	●
16,670	165	160	21/32	16.67	3.00	7.00	11.00	●	●	●	●
17,000	170	160		17.00	3.10	7.00	11.00	●	●	●	●
17,070	170	160	43/64	17.07	3.10	7.00	11.00	●	●	●	●
17,460	170	160	11/16	17.46	3.10	7.00	11.00	●	●	●	●
17,500	175	160		17.50	3.20	7.00	11.00	●	●	●	●
17,600	175	160		17.60	3.20	7.00	11.00	●	●	●	●
17,860	175	160	45/64	17.86	3.30	7.00	11.00	●	●	●	●

Inserts are always supplied with clamping screw, Guhring no. 4071.



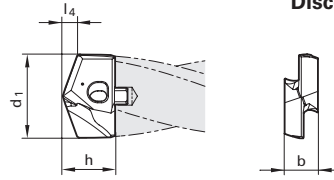

# HT 800 WP Interchangeable Inserts For Machining Stainless Steel

Order no. = Guhring no. + Code-no. 								Guhring no			
								4112	4115	4113	4114
DIN								Guhring std.			
Tool material								Solid carbide			
P								○			
M								○			
K								○			
N								●			
S								○			
H								○			
Surface finish								nanoFIRE			
Discount group								141			
Tolerance								h7			
											
Code no.	for drill. holder size	for pilot holder size	d1		l4	b	h	Availability			
			inch	mm	mm	mm	mm				
18,000	180	180		18.00	3.30	8.00	12.60	●	●	●	●
18,260	180	180	23/32	18.26	3.40	8.00	12.60	●	●	●	●
18,500	185	180		18.50	3.40	8.00	12.60	●	●	●	●
18,650	185	180	47/64	18.65	3.40	8.00	12.60	●	●	●	●
19,000	190	180		19.00	3.50	8.00	12.60	●	●	●	●
19,050	190	180	3/4	19.05	3.50	8.00	12.60	●	●	●	●
19,250	190	180		19.25	3.60	8.00	12.60	●	●	●	●
19,450	190	180	49/64	19.45	3.60	8.00	12.60	●	●	●	●
19,500	195	180		19.50	3.60	8.00	12.60	●	●	●	●
19,600	195	180		19.60	3.60	8.00	12.60	●	●	●	●
19,840	195	180	25/32	19.84	3.70	8.00	12.60	●	●	●	●
20,000	200	200		20.00	3.70	9.00	13.90	●	●	●	●
20,240	200	200	51/64	20.24	3.70	9.00	13.90	●	●	●	●
20,500	205	200		20.50	3.80	9.00	13.90	●	●	●	●
20,640	205	200	13/16	20.64	3.80	9.00	13.90	●	●	●	●
21,000	210	200		21.00	3.90	9.00	13.90	●	●	●	●
21,030	210	200	53/64	21.03	3.90	9.00	13.90	●	●	●	●
21,100	210	200		21.10	3.90	9.00	13.90	●	●	●	●
21,430	210	200	27/32	21.43	3.90	9.00	13.90	●	●	●	●
21,500	215	200		21.50	4.00	9.00	13.90	●	●	●	●
21,830	215	200	55/64	21.83	4.00	9.00	13.90	●	●	●	●
22,000	220	220		22.00	4.10	10.00	15.30	●	●	●	●
22,220	220	220	7/8	22.22	4.10	10.00	15.30	●	●	●	●
22,500	225	220		22.50	4.10	10.00	15.30	●	●	●	●
22,620	225	220	57/64	22.62	4.20	10.00	15.30	●	●	●	●
23,000	230	220		23.00	4.20	10.00	15.30	●	●	●	●
23,020	230	220	29/32	23.02	4.20	10.00	15.30	●	●	●	●
23,420	230	220	59/64	23.42	4.30	10.00	15.30	●	●	●	●
23,500	235	220		23.50	4.30	10.00	15.30	●	●	●	●
23,810	235	220	15/16	23.81	4.40	10.00	15.30	●	●	●	●
24,000	240	240		24.00	4.40	11.00	15.80	●	●	●	●
24,100	240	240		24.10	4.40	11.00	15.80	●	●	●	●
24,210	240	240	61/64	24.21	4.50	11.00	15.80	●	●	●	●
24,500	245	240		24.50	4.50	11.00	15.80	●	●	●	●
24,610	245	240	31/32	24.61	4.50	11.00	15.80	●	●	●	●
25,000	250	240	63/64	25.00	4.60	11.00	15.80	●	●	●	●
25,400	250	240	1	25.40	4.70	11.00	15.80	●	●	●	●
25,500	255	240		25.50	4.70	11.00	15.80	●	●	●	●
25,670	255	240		25.67	4.70	11.00	15.80	●	●	●	●
25,700	255	240		25.70	4.70	11.00	15.80	●	●	●	●
25,810	255	240		25.81	4.70	11.00	15.80	●	●	●	●
26,000	260	260		26.00	4.80	12.00	20.00	●	●	●	●
26,190	260	260	1 1/32	26.19	4.80	12.00	20.00	●	●	●	●
26,500	265	260		26.50	4.90	12.00	20.00	●	●	●	●
26,590	265	260	1 3/64	26.59	4.90	12.00	20.00	●	●	●	●
27,000	270	260		27.00	5.00	12.00	20.00	●	●	●	●
27,500	275	260		27.50	5.10	12.00	20.00	●	●	●	●
27,700	275	260		27.70	5.10	12.00	20.00	●	●	●	●
27,780	275	260	1 3/32	27.78	5.10	12.00	20.00	●	●	●	●
28,000	280	280		28.00	5.10	13.00	20.70	●	●	●	●
28,180	280	280	1 7/64	28.18	5.20	13.00	20.70	●	●	●	●
28,500	285	280		28.50	5.20	13.00	20.70	●	●	●	●
28,580	285	280		28.58	5.30	13.00	20.70	●	●	●	●
29,000	290	280		29.00	5.30	13.00	20.70	●	●	●	●

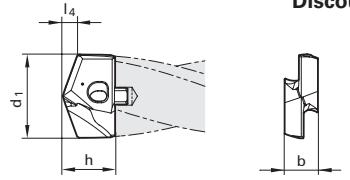

Inserts are always supplied with clamping screw, Guhring no. 4071.

# HT 800 WP Interchangeable Inserts For Machining Cast Iron

Order no. = Guhring no. + Code-no.								Guhring no			
								4112	4115	4113	4114
DIN Tool material P M K N S H Surface finish Discount group Tolerance								Guhring std.	Guhring std.	Guhring std.	Guhring std.
								Solid carbide	Solid carbide	Solid carbide	Solid carbide
								●	○	○	○
								○	●	●	○
								○	○	○	○
								○	○	○	○
								nanoFIRE	TiAlN nanoA	FIRE	bright
								141	141	141	141
								h7	h7	m7	h7
											
Code no.	for drill. holder size	for pilot holder size	d1		l4	b	h	Availability	Availability	Availability	Availability
			inch	mm	mm	mm	mm				
29,370	290	280	1 5/32	29.37	5.40	13.00	20.70	●	●	●	●
29,500	295	280		29.50	5.40	13.00	20.70	●	●	●	●
29,770	295	280	1 11/64	29.77	5.50	13.00	20.70	●	●	●	●
30,000	300	300		30.00	5.50	14.00	22.30	●	●	●	●
30,160	300	300	1 3/16	30.16	5.50	14.00	22.30	●	●	●	●
30,500	305	300		30.50	5.60	14.00	22.30	●	●	●	●
30,960	305	300	1 7/32	30.96	5.70	14.00	22.30	●	●	●	●
31,000	310	300		31.00	5.70	14.00	22.30	●	●	●	●
31,500	315	300		31.50	5.80	14.00	22.30	●	●	●	●
31,750	315	300	1 1/4	31.75	5.80	14.00	22.30	●	●	●	●
32,000	320	320		32.00	5.90	15.00	23.10	●	●	●	●
32,500	320	320		32.50	6.00	15.00	23.10	●	●	●	●
32,540	320	320	1 9/32	32.54	6.00	15.00	23.10	●	●	●	●
32,940	320	320	1 19/6	32.94	6.00	15.00	23.10	●	●	●	●
33,000	330	320		33.00	6.10	15.00	23.10	●	●	●	●
33,340	330	320	1 5/16	33.34	6.10	15.00	23.10	●	●	●	●
33,500	330	320		33.50	6.10	15.00	23.10	●	●	●	●
34,000	340	320		34.00	6.20	15.00	23.10	●	●	●	●
34,130	340	320	1 11/3	34.13	6.30	15.00	23.10	●	●	●	●
34,500	340	320		34.50	6.30	15.00	23.10	●	●	●	●
34,930	340	320		34.93	6.40	15.00	23.10	●	●	●	●
35,000	350	360		35.00	6.40	15.00	23.10	●	●	●	●
35,500	350	360		35.50	6.50	15.00	23.10	●	●	●	●
35,720	350	360	1 13/3	35.72	6.60	15.00	23.10	●	●	●	●
36,000	360	360		36.00	6.60	16.00	23.90	●	●	●	●
36,500	360	360		36.50	6.70	16.00	23.90	●	●	●	●
36,510	360	360	1 7/16	36.51	6.70	16.00	23.90	●	●	●	●
37,000	370	360		37.00	6.80	16.00	23.90	●	●	●	●
37,310	370	360	1 15/3	37.31	6.80	16.00	23.90	●	●	●	●
37,500	370	360		37.50	6.90	16.00	23.90	●	●	●	●
38,000	380	360		38.00	7.00	16.00	23.90	●	●	●	●
38,100	380	360	1 1/2	38.10	7.00	16.00	23.90	●	●	●	●
38,460	380	360		38.46	7.00	16.00	23.90	●	●	●	●
38,500	380	360	1 33/6	38.50	7.10	16.00	23.90	●	●	●	●
39,000	390	360		39.00	7.10	16.00	23.90	●	●	●	●
39,500	390	360		39.50	7.20	16.00	23.90	●	●	●	●
40,000	390	360		40.00	7.30	16.00	23.90	●	●	●	●

Inserts are always supplied with clamping screw, Guhring no. 4071.

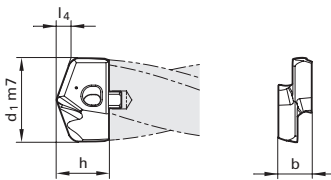
# HT 800 WP Interchangeable Inserts For Machining Aluminium

Order no. = Guhring no. + Code-no.	Guhring no							4111
	DIN							Guhring std.
	Tool material							Solid carbide
	P							○
	M							○
	K							○
	N							○
	S							○
	H							○
	Surface finish							nanoA
Discount group							141	
Tolerance							m7	
								
Code no.	for drill. holder size	for pilot holder size	d1		l4	b	h	Availability
			inch	mm	mm	mm	mm	
11,000	110	110		11.00	1.80	4.50	7.20	●
11,200	110	110		11.20	1.80	4.50	7.20	●
11,500	115	110		11.50	1.80	4.50	7.20	●
11,510	115	110	29/64	11.51	1.80	4.50	7.20	●
11,700	115	110		11.70	1.90	4.50	7.20	●
11,800	115	110		11.80	1.90	4.50	7.20	●
11,910	115	110	15/32	11.91	1.90	4.50	7.20	●
12,000	120	120		12.00	1.90	5.00	7.40	●
12,100	120	120		12.10	1.90	5.00	7.40	●
12,200	120	120		12.20	1.90	5.00	7.40	●
12,300	120	120	31/64	12.30	1.90	5.00	7.40	●
12,500	125	120		12.50	2.00	5.00	7.40	●
12,600	125	120		12.60	2.00	5.00	7.40	●
12,700	125	120	1/2	12.70	2.00	5.00	7.40	●
12,800	125	120		12.80	2.00	5.00	7.40	●
12,900	125	120		12.90	2.00	5.00	7.40	●
13,000	130	130		13.00	2.00	5.50	8.20	●
13,100	130	130	33/64	13.10	2.00	5.50	8.20	●
13,490	130	130	17/32	13.49	2.10	5.50	8.20	●
13,500	135	130		13.50	2.10	5.50	8.20	●
13,600	135	130		13.60	2.10	5.50	8.20	●
13,700	135	130		13.70	2.10	5.50	8.20	●
13,800	135	130		13.80	2.20	5.50	8.20	●
13,890	135	130	35/64	13.89	2.20	5.50	8.20	●
14,000	140	140		14.00	2.20	6.00	9.40	●
14,100	140	140		14.10	2.20	6.00	9.40	●
14,290	140	140	9/16	14.29	2.20	6.00	9.40	●
14,400	140	140		14.40	2.20	6.00	9.40	●
14,500	145	140		14.50	2.20	6.00	9.40	●
14,600	145	140		14.60	2.30	6.00	9.40	●
14,680	145	140	37/64	14.68	2.30	6.00	9.40	●
14,700	145	140		14.70	2.30	6.00	9.40	●
14,800	145	140		14.80	2.30	6.00	9.40	●
15,000	150	140		15.00	2.30	6.00	9.40	●
15,080	150	140	19/32	15.08	2.30	6.00	9.40	●
15,100	150	140		15.10	2.30	6.00	9.40	●
15,200	150	140		15.20	2.30	6.00	9.40	●
15,300	150	140		15.30	2.40	6.00	9.40	●
15,480	150	140	39/64	15.48	2.40	6.00	9.40	●
15,500	155	140		15.50	2.40	6.00	9.40	●
15,600	155	140		15.60	2.40	6.00	9.40	●
15,700	155	140		15.70	2.40	6.00	9.40	●
15,800	155	140		15.80	2.40	6.00	9.40	●
15,870	155	140	5/8	15.87	2.40	6.00	9.40	●
16,000	160	160		16.00	2.50	7.00	10.60	●
16,270	160	160	41/64	16.27	2.60	7.00	10.60	●
16,500	165	160		16.50	2.60	7.00	10.60	●
16,670	165	160	21/32	16.67	2.60	7.00	10.60	●
17,000	170	160		17.00	2.70	7.00	10.60	●
17,070	170	160	43/64	17.07	2.70	7.00	10.60	●
17,460	170	160	11/16	17.46	2.70	7.00	10.60	●
17,500	175	160		17.50	2.70	7.00	10.60	●
17,600	175	160		17.60	2.70	7.00	10.60	●
17,860	175	160	45/64	17.86	2.80	7.00	10.60	●



Inserts are always supplied with clamping screw, Guhring no. 4071.

# HT 800 WP Interchangeable Inserts For Pilot Holes

Order no. = Guhring no. + Code-no.	Guhring no							4111
	DIN							Guhring std.
	Tool material							Solid carbide
	P							○
	M							○
	K							○
	N							○
	S							○
	H							○
	Surface finish							nanoA
Discount group							141	
Tolerance							m7	
Code no.	for drill. holder size	for pilot holder size	d1		l4	b	h	Availability
			inch	mm	mm	mm	mm	
18,000	180	180		18.00	2.80	8.00	12.10	●
18,260	180	180	23/32	18.26	2.80	8.00	12.10	●
18,500	185	180		18.50	2.90	8.00	12.10	●
18,650	185	180	47/64	18.65	2.90	8.00	12.10	●
19,000	190	180		19.00	2.90	8.00	12.10	●
19,050	190	180	3/4	19.05	2.90	8.00	12.10	●
19,450	190	180	49/64	19.45	3.00	8.00	12.10	●
19,500	195	180		19.50	3.00	8.00	12.10	●
19,600	195	180		19.60	3.00	8.00	12.10	●
19,840	195	180	25/32	19.84	3.10	8.00	12.10	●
20,000	200	200		20.00	3.10	9.00	13.30	●
20,240	200	200	51/64	20.24	3.10	9.00	13.30	●
20,500	205	200		20.50	3.10	9.00	13.30	●
20,640	205	200	13/16	20.64	3.20	9.00	13.30	●
21,000	210	200		21.00	3.20	9.00	13.30	●
21,030	210	200	53/64	21.03	3.20	9.00	13.30	●
21,100	210	200		21.10	3.20	9.00	13.30	●
21,430	210	200	27/32	21.43	3.30	9.00	13.30	●
21,500	215	200		21.50	3.30	9.00	13.30	●
21,830	215	200	55/64	21.83	3.30	9.00	13.30	●
22,000	220	220		22.00	3.50	10.00	14.80	●
22,220	220	220	7/8	22.22	3.50	10.00	14.80	●
22,500	225	220		22.50	3.50	10.00	14.80	●
22,620	225	220	57/64	22.62	3.50	10.00	14.80	●
23,000	230	220		23.00	3.60	10.00	14.80	●
23,020	230	220	29/32	23.02	3.60	10.00	14.80	●
23,420	230	220	59/64	23.42	3.60	10.00	14.80	●
23,500	235	220		23.50	3.60	10.00	14.80	●
23,810	235	220	15/16	23.81	3.70	10.00	14.80	●
24,000	240	240		24.00	3.80	11.00	15.30	●
24,100	240	240		24.10	3.80	11.00	15.30	●
24,210	240	240	61/64	24.21	3.80	11.00	15.30	●
24,500	245	240		24.50	3.90	11.00	15.30	●
24,610	245	240	31/32	24.61	3.90	11.00	15.30	●
25,000	250	240		25.00	4.00	11.00	15.30	●
25,400	250	240	1	25.40	4.00	11.00	15.30	●
25,500	255	240		25.50	4.00	11.00	15.30	●
25,700	255	240		25.70	4.10	11.00	15.30	●
26,000	260	260		26.00	4.10	12.00	19.40	●
26,190	260	260	1 1/32	26.19	4.10	12.00	19.40	●
26,500	265	260		26.50	4.10	12.00	19.40	●
26,590	265	260	1 3/64	26.59	4.20	12.00	19.40	●
27,000	270	260		27.00	4.20	12.00	19.40	●
27,500	275	260		27.50	4.30	12.00	19.40	●
27,700	275	260		27.70	4.30	12.00	19.40	●
27,780	275	260	1 3/32	27.78	4.30	12.00	19.40	●
28,000	280	280		28.00	4.40	13.00	20.10	●
28,180	280	280		28.18	4.40	13.00	20.10	●
28,500	285	280		28.50	4.50	13.00	20.10	●
28,580	285	280		28.58	4.50	13.00	20.10	●
29,000	290	280		29.00	4.60	13.00	20.10	●
29,370	290	280	1 5/32	29.37	4.60	13.00	20.10	●
29,500	295	280		29.50	4.60	13.00	20.10	●
30,000	300	300		30.00	4.70	14.00	21.70	●

Inserts are always supplied with clamping screw, Guhring no. 4071.

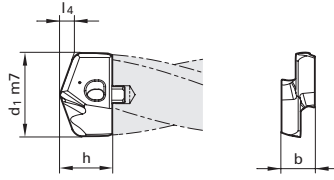
HT 800 WP Interchangeable Inserts For Pilot Holes

Order no. = Guhring no. + Code-no.								Guhring no	
								4111	
								DIN	Guhring std.
								Tool material	Solid carbide
								P	○
								M	○
								K	○
								N	○
								S	○
								H	○
								Surface finish	nanoA
								Discount group	141
								Tolerance	m7
									
Code no.	for drill. holder size	for pilot holder size	d1		l4	b	h	Availability	
			inch	mm	mm	mm	mm		
30,160	300	300	1 3/16	30.16	4.70	14.00	21.70	●	
30,500	305	300		30.50	4.80	14.00	21.70	●	
30,960	305	300		30.96	4.80	14.00	21.70	●	
31,000	310	300		31.00	4.90	14.00	21.70	●	
31,500	315	300		31.50	4.90	14.00	21.70	●	
31,750	315	300	1 1/4	31.75	4.90	14.00	21.70	●	
32,000	320	320		32.00	5.00	15.00	22.40	●	
32,500	320	320		32.50	5.10	15.00	22.40	●	
32,540	320	320	1 9/32	32.54	5.10	15.00	22.40	●	
33,000	330	320		33.00	5.20	15.00	22.40	●	
33,340	330	320	1 5/16	33.34	5.20	15.00	22.40	●	
33,500	330	320		33.50	5.30	15.00	22.40	●	
34,000	340	320		34.00	5.40	15.00	22.40	●	
34,130	340	320	1 11/32	34.13	5.40	15.00	22.40	●	
34,500	340	320		34.50	5.40	15.00	22.40	●	
34,930	340	320		34.93	5.40	15.00	22.40	●	
35,000	350	320		35.00	5.50	15.00	22.40	●	
35,500	350	320		35.50	5.60	15.00	22.40	●	
35,720	350	320		35.72	5.60	15.00	22.40	●	
36,000	360	360		36.00	5.70	16.00	23.20	●	
36,500	360	360		36.50	5.70	16.00	23.20	●	
36,510	360	360		36.51	5.70	16.00	23.20	●	
37,000	370	360		37.00	5.80	16.00	23.20	●	
37,310	370	360	1 15/32	37.31	5.80	16.00	23.20	●	
37,500	370	360		37.50	5.90	16.00	23.20	●	
38,000	380	360		38.00	6.00	16.00	23.20	●	
38,100	380	360	1 1/2	38.10	6.00	16.00	23.20	●	
38,500	380	360	1 33/64	38.50	6.10	16.00	23.20	●	
39,000	390	360		39.00	6.20	16.00	23.20	●	
39,500	390	360		39.50	6.20	16.00	23.20	●	
40,000	390	360		40.00	6.20	16.00	23.20	●	

Inserts are always supplied with clamping screw, Guhring no. 4071.

Order no. = Guhring no. + Code-no.

**Guhring no**  
**DIN**  
**Tool material**  
 P  
 M  
 K  
 N  
 S  
 H  
**Surface finish**  
**Discount group**

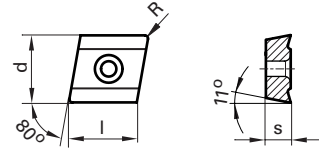

Code no.	size	for holder size	d mm	s mm	R mm	l mm
52,040	CPGT050204R	110 - 140	5.56	2.38	0.4	5.64
62,040	CPGT060204R	160 - 280	6.35	2.38	0.4	6.45
93,080	CPGT09T308R	300 - 360	9.53	3.97	0.8	9.67

<b>7645</b>
<b>Guhring std.</b>
<b>Solid carbide</b>
●
○
○
○
○
○
TiN
142

<b>Availability</b>
●
●
●

Order no. = Guhring no. + Code-no.

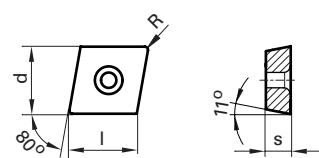
**Guhring no**  
**DIN**  
**Tool material**  
 P  
 M  
 K  
 N  
 S  
 H  
**Surface finish**  
**Discount group**



Code no.	size	for holder size	d mm	s mm	R mm	l mm
52,040	CPGW050204	110 - 140	5.56	2.38	0.4	5.64
62,040	CPGW060204	160 - 280	6.35	2.38	0.4	6.45
93,080	CPGW09T308	300 - 360	9.53	3.97	0.8	9.67

<b>7632</b>
<b>Guhring std.</b>
<b>Solid carbide</b>
○
○
●
○
○
○
TiAlN
142

<b>Availability</b>
●
●
●

Order no. = Guhring no. + Code-no.

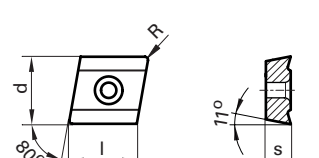
**Guhring no**  
**DIN**  
**Tool material**  
 P  
 M  
 K  
 N  
 S  
 H  
**Surface finish**  
**Discount group**





Code no.	size	for holder size	d mm	s mm	R mm	l mm
52,040	CPGT050204R	110 - 140	5.56	2.38	0.4	5.64
62,040	CPGT060204R	160 - 280	6.35	2.38	0.4	6.45
93,080	CPGT09T308R	300 - 360	9.53	3.97	0.8	9.67

<b>7635</b>
<b>Guhring std.</b>
<b>Solid carbide</b>
○
○
○
●
○
○
bright
142

<b>Availability</b>
●
●
●

# HT 800 WP Special Solutions

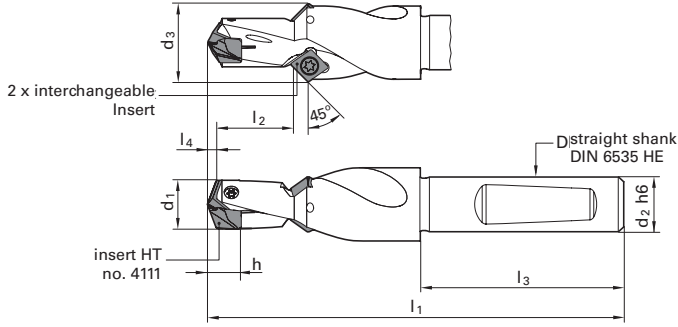
- stepped holders
- special clamping chucks
- inserts with special coatings and geometries, e.g. radius inserts or inserts with point angles  $90^\circ$  to  $180^\circ$



Order no. = Guhring no. + Code-no.	Guhring no. Discount group							4105
								140
 <p>*l1 with pilot insert Guhring no. 4111 only. With drilling insert Guhring no. 4112, 4113, 4114 or 4115, see h and l4 dimensions page 8 to 10!</p>								
Code no.	Holder size	d1 mm	d2h6 mm	d3 mm	incl. WP l1* mm	l2 max mm	l3 mm	
11,000	110	11.00 - 11.99	12.00	17.00	81.00	12.00	45.00	●
11,005	110	11.00 - 11.99	12.70	17.00	81.00	12.00	45.00	●
12,000	120	12.00 - 12.99	12.00	18.00	84.00	13.00	45.00	●
12,005	120	12.00 - 12.99	12.70	18.00	84.00	13.00	45.00	●
13,000	130	13.00 - 13.99	14.00	18.00	86.00	14.00	45.00	●
13,005	130	13.00 - 13.99	15.875	18.00	86.00	14.00	45.00	●
14,000	140	14.00 - 15.99	16.00	18.00	93.00	16.00	48.00	●
14,005	140	14.00 - 15.99	15.875	18.00	93.00	16.00	48.00	●
16,000	160	16.00 - 17.99	18.00	20.00	99.00	18.00	48.00	●
16,005	160	16.00 - 17.99	19.05	20.00	99.00	18.00	48.00	●
18,000	180	18.00 - 19.99	20.00	22.00	106.00	20.00	50.00	●
18,005	180	18.00 - 19.99	19.05	22.00	106.00	20.00	50.00	●
20,000	200	20.00 - 21.99	25.00	24.00	117.00	22.00	56.00	●
20,005	200	20.00 - 21.99	25.40	24.00	117.00	22.00	56.00	●
22,000	220	22.00 - 23.99	25.00	26.00	122.00	24.00	56.00	●
22,005	220	22.00 - 23.99	25.40	26.00	122.00	24.00	56.00	●
24,000	240	24.00 - 25.99	25.00	28.00	128.00	26.00	56.00	●
24,005	240	24.00 - 25.99	25.40	28.00	128.00	26.00	56.00	●
26,000	260	26.00 - 27.99	32.00	32.00	142.00	28.00	60.00	●
26,005	260	26.00 - 27.99	31.75	32.00	142.00	28.00	60.00	●
28,000	280	28.00 - 29.99	32.00	34.00	147.00	30.00	60.00	●
28,005	280	28.00 - 29.99	31.75	34.00	147.00	30.00	60.00	●
30,000	300	30.00 - 31.99	32.00	38.00	152.00	32.00	60.00	●
30,005	300	30.00 - 31.99	31.75	38.00	152.00	32.00	60.00	●
32,000	320	32.00 - 35.99	32.00	42.00	163.00	36.00	60.00	●
32,005	320	32.00 - 35.99	31.75	42.00	163.00	36.00	60.00	●
36,000	360	36.00 - 40.00	32.00	46.00	173.00	40.00	60.00	●
36,005	360	36.00 - 40.00	31.75	46.00	173.00	40.00	60.00	●

Holders are always supplied with clamping screw, Guhring no. 4071, and screwdriver, Guhring no. 1612.



# HT 800 WP Interchangeable Insert Holders 1.5 x D

Guhring no.

Discount group

4106

140

Order no. = Guhring no. + Code-no.

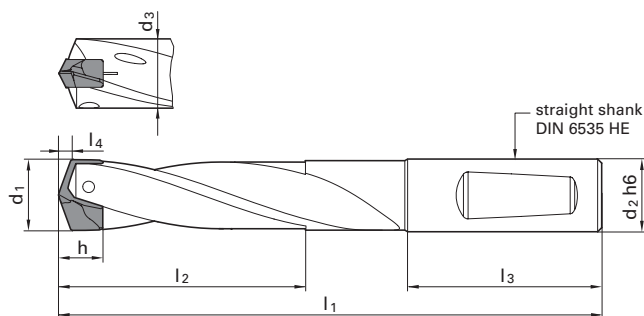

\*l1 with drilling insert Guhring no. 4112, 4113, 4114 or 4115 only.  
With pilot insert Guhring no. 4111, see h and l4 dimensions page 11 to 13!





Availability

Code no.	Holder size	d1 mm	d2h6 mm	d3 mm	incl. WP l1* mm	l2 max mm	l3 mm	Availability
11,000	110	11.00 - 11.49	12.00	10.70	84.00	19.30	45.00	●
11,005	110	11.00 - 11.49	12.70	10.70	84.00	19.30	45.00	●
11,500	115	11.50 - 11.99	12.00	11.20	85.00	20.10	45.00	●
11,505	115	11.50 - 11.99	12.70	11.20	85.00	20.10	45.00	●
12,000	120	12.00 - 12.49	12.00	11.70	87.00	21.00	45.00	●
12,005	120	12.00 - 12.49	12.70	11.70	87.00	21.00	45.00	●
12,500	125	12.50 - 12.99	14.00	12.20	89.00	21.90	45.00	●
12,505	125	12.50 - 12.99	15.875	12.20	89.00	21.90	45.00	●
13,000	130	13.00 - 13.49	14.00	12.70	90.00	22.60	45.00	●
13,005	130	13.00 - 13.49	15.875	12.70	90.00	22.60	45.00	●
13,500	135	13.50 - 13.99	14.00	13.20	92.00	23.60	45.00	●
13,505	135	13.50 - 13.99	15.875	13.20	92.00	23.60	45.00	●
14,000	140	14.00 - 14.49	14.00	13.70	93.00	24.50	45.00	●
14,005	140	14.00 - 14.49	15.875	13.70	93.00	24.50	45.00	●
14,500	145	14.50 - 14.99	16.00	14.20	98.00	25.30	48.00	●
14,505	145	14.50 - 14.99	15.875	14.20	98.00	25.30	48.00	●
15,000	150	15.00 - 15.49	16.00	14.70	100.00	26.10	48.00	●
15,005	150	15.00 - 15.49	15.875	14.70	100.00	26.10	48.00	●
15,500	155	15.50 - 15.99	16.00	15.20	101.00	27.00	48.00	●
15,505	155	15.50 - 15.99	15.875	15.20	101.00	27.00	48.00	●
16,000	160	16.00 - 16.49	16.00	15.70	102.00	27.80	48.00	●
16,005	160	16.00 - 16.49	15.875	15.70	102.00	27.80	48.00	●
16,500	165	16.50 - 16.99	18.00	16.20	105.00	28.70	48.00	●
16,505	165	16.50 - 16.99	19.05	16.20	105.00	28.70	48.00	●
17,000	170	17.00 - 17.49	18.00	16.70	106.00	29.60	48.00	●
17,005	170	17.00 - 17.49	19.05	16.70	106.00	29.60	48.00	●
17,500	175	17.50 - 17.99	18.00	17.20	107.00	30.40	48.00	●
17,505	175	17.50 - 17.99	19.05	17.20	107.00	30.40	48.00	●
18,000	180	18.00 - 18.49	18.00	17.70	109.00	31.20	48.00	●
18,005	180	18.00 - 18.49	19.05	17.70	109.00	31.20	48.00	●
18,500	185	18.50 - 18.99	20.00	18.20	113.00	32.10	50.00	●
18,505	185	18.50 - 18.99	19.05	18.20	113.00	32.10	50.00	●
19,000	190	19.00 - 19.49	20.00	18.70	114.00	32.90	50.00	●
19,005	190	19.00 - 19.49	19.05	18.70	114.00	32.90	50.00	●
19,500	195	19.50 - 19.99	20.00	19.20	116.00	33.70	50.00	●
19,505	195	19.50 - 19.99	19.05	19.20	116.00	33.70	50.00	●
20,000	200	20.00 - 20.49	20.00	19.70	117.00	34.60	50.00	●
20,005	200	20.00 - 20.49	19.05	19.70	117.00	34.60	50.00	●
20,500	205	20.50 - 20.99	25.00	20.20	128.00	35.50	56.00	●
20,505	205	20.50 - 20.99	25.40	20.20	128.00	35.50	56.00	●
21,000	210	21.00 - 21.49	25.00	20.70	129.00	36.40	56.00	●
21,005	210	21.00 - 21.49	25.40	20.70	129.00	36.40	56.00	●
21,500	215	21.50 - 21.99	25.00	21.20	130.00	37.20	56.00	●
21,505	215	21.50 - 21.99	25.40	21.20	130.00	37.20	56.00	●
22,000	220	22.00 - 22.49	25.00	21.70	131.00	38.00	56.00	●
22,005	220	22.00 - 22.49	25.40	21.70	131.00	38.00	56.00	●
22,500	225	22.50 - 22.99	25.00	22.20	134.00	38.90	56.00	●
22,505	225	22.50 - 22.99	25.40	22.20	134.00	38.90	56.00	●
23,000	230	23.00 - 23.49	25.00	22.70	135.00	39.80	56.00	●
23,005	230	23.00 - 23.49	25.40	22.70	135.00	39.80	56.00	●
23,500	235	23.50 - 23.99	25.00	23.20	137.00	40.60	56.00	●

Holders are always supplied with clamping screw, Guhring no. 4071, and screwdriver, Guhring no. 1612.

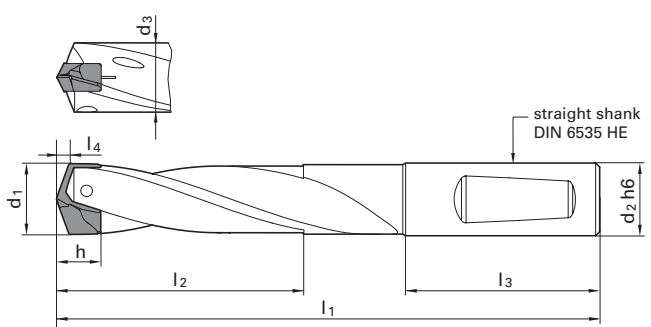
# HT 800 WP Interchangeable Insert Holders 1.5 x D

Order no. = Guhring no. + Code-no.	Guhring no.							4106
	Discount group							140
 <p>*l1 with drilling insert Guhring no. 4112, 4113, 4114 or 4115 only. With pilot insert Guhring no. 4111, see h and l4 dimensions page 11 to 13!</p>								
Code no.	Holder size	d1 mm	d2h6 mm	d3 mm	incl. WP l1* mm	l2 max mm	l3 mm	
23,505	235	23.50 - 23.99	25.40	23.20	137.00	40.60	56.00	●
24,000	240	24.00 - 24.49	25.00	23.70	138.00	41.50	56.00	●
24,005	240	24.00 - 24.49	25.40	23.70	138.00	41.50	56.00	●
24,500	245	24.50 - 24.99	25.00	24.20	140.00	42.30	56.00	●
24,505	245	24.50 - 24.99	25.40	24.20	140.00	42.30	56.00	●
25,000	250	25.00 - 25.49	25.00	24.70	142.00	43.20	56.00	●
25,005	250	25.00 - 25.49	25.40	24.70	142.00	43.20	56.00	●
25,500	255	25.50 - 25.99	32.00	25.20	148.00	44.00	60.00	●
25,505	255	25.50 - 25.99	31.75	25.20	148.00	44.00	60.00	●
26,000	260	26.00 - 26.49	32.00	25.70	151.00	44.30	60.00	●
26,005	260	26.00 - 26.49	31.75	25.70	151.00	44.30	60.00	●
26,500	265	26.50 - 26.99	32.00	26.20	153.00	45.10	60.00	●
26,505	265	26.50 - 26.99	31.75	26.20	153.00	45.10	60.00	●
27,000	270	27.00 - 27.49	32.00	26.70	155.00	46.00	60.00	●
27,005	270	27.00 - 27.49	31.75	26.70	155.00	46.00	60.00	●
27,500	275	27.50 - 27.99	32.00	27.20	156.00	46.80	60.00	●
27,505	275	27.50 - 27.99	31.75	27.20	156.00	46.80	60.00	●
28,000	280	28.00 - 28.49	32.00	27.70	157.00	47.70	60.00	●
28,005	280	28.00 - 28.49	31.75	27.70	157.00	47.70	60.00	●
28,500	285	28.50 - 28.99	32.00	28.20	159.00	48.50	60.00	●
28,505	285	28.50 - 28.99	31.75	28.20	159.00	48.50	60.00	●
29,000	290	29.00 - 29.49	32.00	28.70	161.00	49.40	60.00	●
29,005	290	29.00 - 29.49	31.75	28.70	161.00	49.40	60.00	●
29,500	295	29.50 - 29.99	32.00	29.20	162.00	50.20	60.00	●
29,505	295	29.50 - 29.99	31.75	29.20	162.00	50.20	60.00	●
30,000	300	30.00 - 30.49	32.00	29.70	164.00	50.90	60.00	●
30,005	300	30.00 - 30.49	31.75	29.70	164.00	50.90	60.00	●
30,500	305	30.50 - 30.99	32.00	30.20	166.00	51.70	60.00	●
30,505	305	30.50 - 30.99	31.75	30.20	166.00	51.70	60.00	●
31,000	310	31.00 - 31.49	32.00	30.70	167.00	52.60	60.00	●
31,005	310	31.00 - 31.49	31.75	30.70	167.00	52.60	60.00	●
31,500	315	31.50 - 31.99	32.00	31.20	168.00	53.40	60.00	●
31,505	315	31.50 - 31.99	31.75	31.20	168.00	53.40	60.00	●
32,000	320	32.00 - 32.99	32.00	31.70	172.00	55.10	60.00	●
32,005	320	32.00 - 32.99	31.75	31.70	172.00	55.10	60.00	●
33,000	330	33.00 - 33.99	32.00	32.70	175.00	56.80	60.00	●
33,005	330	33.00 - 33.99	31.75	32.70	175.00	56.80	60.00	●
34,000	340	34.00 - 34.99	32.00	33.70	178.00	58.50	60.00	●
34,005	340	34.00 - 34.99	31.75	33.70	178.00	58.50	60.00	●
35,000	350	35.00 - 35.99	32.00	34.70	181.00	60.20	60.00	●
35,005	350	35.00 - 35.99	31.75	34.70	181.00	60.20	60.00	●
36,000	360	36.00 - 36.99	32.00	35.70	184.00	61.80	60.00	●
36,005	360	36.00 - 36.99	31.75	35.70	184.00	61.80	60.00	●
37,000	370	37.00 - 37.99	32.00	36.70	188.00	63.50	60.00	●
37,005	370	37.00 - 37.99	31.75	36.70	188.00	63.50	60.00	●
38,000	380	38.00 - 38.99	32.00	37.70	191.00	65.20	60.00	●
38,005	380	38.00 - 38.99	31.75	37.70	191.00	65.20	60.00	●
39,000	390	39.00 - 40.00	32.00	38.70	194.00	66.90	60.00	●
39,005	390	39.00 - 40.00	31.75	38.70	194.00	66.90	60.00	●

Holders are always supplied with clamping screw, Guhring no. 4071, and screwdriver, Guhring no. 1612.

Guhring no.

Discount group

4107

140

Order no. = Guhring no. + Code-no.

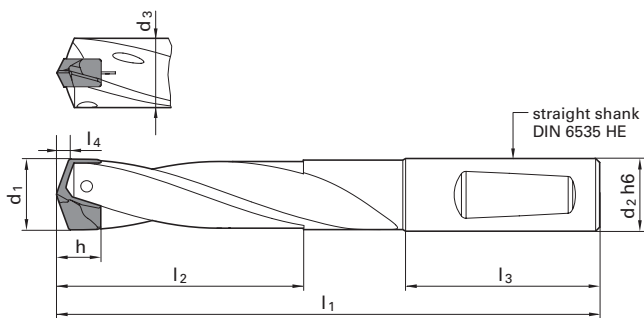

\*l1 with drilling insert Guhring no. 4112, 4113, 4114 or 4115 only.  
With pilot insert Guhring no. 4111, see h and l4 dimensions page 11 to 13!



Availability

Code no.	Holder size	d1 mm	d2h6 mm	d3 mm	incl. WP l1* mm	l2 max mm	l3 mm	Availability
11,000	110	11.00 - 11.49	12.00	10.70	101.00	36.60	45.00	●
11,005	110	11.00 - 11.49	12.70	10.70	101.00	36.60	45.00	●
11,500	115	11.50 - 11.99	12.00	11.20	103.00	38.10	45.00	●
11,505	115	11.50 - 11.99	12.70	11.20	103.00	38.10	45.00	●
12,000	120	12.00 - 12.49	12.00	11.70	106.00	39.70	45.00	●
12,005	120	12.00 - 12.49	12.70	11.70	106.00	39.70	45.00	●
12,500	125	12.50 - 12.99	14.00	12.20	108.00	41.30	45.00	●
12,505	125	12.50 - 12.99	15.875	12.20	108.00	41.30	45.00	●
13,000	130	13.00 - 13.49	14.00	12.70	110.00	42.90	45.00	●
13,005	130	13.00 - 13.49	15.875	12.70	110.00	42.90	45.00	●
13,500	135	13.50 - 13.99	14.00	13.20	113.00	44.60	45.00	●
13,505	135	13.50 - 13.99	15.875	13.20	113.00	44.60	45.00	●
14,000	140	14.00 - 14.49	14.00	13.70	115.00	46.20	45.00	●
14,005	140	14.00 - 14.49	15.875	13.70	115.00	46.20	45.00	●
14,500	145	14.50 - 14.99	16.00	14.20	120.00	47.80	48.00	●
14,505	145	14.50 - 14.99	15.875	14.20	120.00	47.80	48.00	●
15,000	150	15.00 - 15.49	16.00	14.70	123.00	49.30	48.00	●
15,005	150	15.00 - 15.49	15.875	14.70	123.00	49.30	48.00	●
15,500	155	15.50 - 15.99	16.00	15.20	125.00	50.90	48.00	●
15,505	155	15.50 - 15.99	15.875	15.20	125.00	50.90	48.00	●
16,000	160	16.00 - 16.49	16.00	15.70	127.00	52.90	48.00	●
16,005	160	16.00 - 16.49	15.875	15.70	127.00	52.90	48.00	●
16,500	165	16.50 - 16.99	18.00	16.20	130.00	54.10	48.00	●
16,505	165	16.50 - 16.99	19.05	16.20	130.00	54.10	48.00	●
17,000	170	17.00 - 17.49	18.00	16.70	132.00	55.80	48.00	●
17,005	170	17.00 - 17.49	19.05	16.70	132.00	55.80	48.00	●
17,500	175	17.50 - 17.99	18.00	17.20	134.00	57.40	48.00	●
17,505	175	17.50 - 17.99	19.05	17.20	134.00	57.40	48.00	●
18,000	180	18.00 - 18.49	18.00	17.70	137.00	58.90	48.00	●
18,005	180	18.00 - 18.49	19.05	17.70	137.00	58.90	48.00	●
18,500	185	18.50 - 18.99	20.00	18.20	141.00	60.50	50.00	●
18,505	185	18.50 - 18.99	19.05	18.20	141.00	60.50	50.00	●
19,000	190	19.00 - 19.49	20.00	18.70	143.00	62.10	50.00	●
19,005	190	19.00 - 19.49	19.05	18.70	143.00	62.10	50.00	●
19,500	195	19.50 - 19.99	20.00	19.20	146.00	63.70	50.00	●
19,505	195	19.50 - 19.99	19.05	19.20	146.00	63.70	50.00	●
20,000	200	20.00 - 20.49	20.00	19.70	148.00	65.30	50.00	●
20,005	200	20.00 - 20.49	19.05	19.70	148.00	65.30	50.00	●
20,500	205	20.50 - 20.99	25.00	20.20	159.00	67.00	56.00	●
20,505	205	20.50 - 20.99	25.40	20.20	159.00	67.00	56.00	●
21,000	210	21.00 - 21.49	25.00	20.70	161.00	68.60	56.00	●
21,005	210	21.00 - 21.49	25.40	20.70	161.00	68.60	56.00	●

Holders are always supplied with clamping screw, Guhring no. 4071, and screwdriver, Guhring no. 1612.

Order no. = Guhring no. + Code-no.

Guhring no.  
Discount group

4107

140

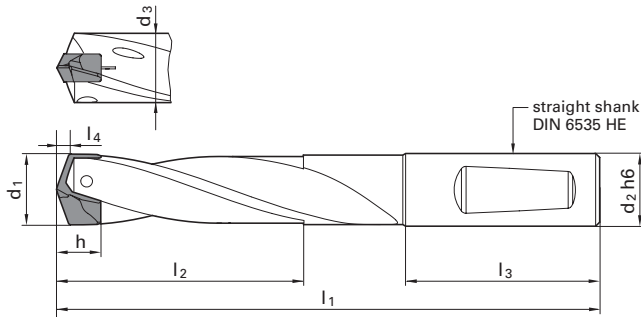

\*l1 with drilling insert Guhring no. 4112, 4113, 4114 or 4115 only.  
With pilot insert Guhring no. 4111, see h and l4 dimensions page 11 to 13!



Availability

Code no.	Holder size	d1 mm	d2h6 mm	d3 mm	incl. WP l1* mm	l2 max mm	l3 mm	Availability
21,500	215	21.50 - 21.99	25.00	21.20	163.00	70.10	56.00	●
21,505	215	21.50 - 21.99	25.40	21.20	163.00	70.10	56.00	●
22,000	220	22.00 - 22.49	25.00	21.70	165.00	71.70	56.00	●
22,005	220	22.00 - 22.49	25.40	21.70	165.00	71.70	56.00	●
22,500	225	22.50 - 22.99	25.00	22.20	168.00	73.30	56.00	●
22,505	225	22.50 - 22.99	25.40	22.20	168.00	73.30	56.00	●
23,000	230	23.00 - 23.49	25.00	22.70	170.00	74.90	56.00	●
23,005	230	23.00 - 23.49	25.40	22.70	170.00	74.90	56.00	●
23,500	235	23.50 - 23.99	25.00	23.20	173.00	76.50	56.00	●
23,505	235	23.50 - 23.99	25.40	23.20	173.00	76.50	56.00	●
24,000	240	24.00 - 24.49	25.00	23.70	175.00	78.10	56.00	●
24,005	240	24.00 - 24.49	25.40	23.70	175.00	78.10	56.00	●
24,500	245	24.50 - 24.99	25.00	24.20	177.00	79.70	56.00	●
24,505	245	24.50 - 24.99	25.40	24.20	177.00	79.70	56.00	●
25,000	250	25.00 - 25.49	25.00	24.70	180.00	81.30	56.00	●
25,005	250	25.00 - 25.49	25.40	24.70	180.00	81.30	56.00	●
25,500	255	25.50 - 25.99	32.00	25.20	187.00	82.90	60.00	●
25,505	255	25.50 - 25.99	31.75	25.20	187.00	82.90	60.00	●
26,000	260	26.00 - 26.49	32.00	25.70	191.00	84.00	60.00	●
26,005	260	26.00 - 26.49	31.75	25.70	191.00	84.00	60.00	●
26,500	265	26.50 - 26.99	32.00	26.20	193.00	86.10	60.00	●
26,505	265	26.50 - 26.99	31.75	26.20	193.00	86.10	60.00	●
27,000	270	27.00 - 27.49	32.00	26.70	196.00	87.20	60.00	●
27,005	270	27.00 - 27.49	31.75	26.70	196.00	87.20	60.00	●
27,500	275	27.50 - 27.99	32.00	27.20	198.00	88.90	60.00	●
27,505	275	27.50 - 27.99	31.75	27.20	198.00	88.90	60.00	●
28,000	280	28.00 - 28.49	32.00	27.70	200.00	90.50	60.00	●
28,005	280	28.00 - 28.49	31.75	27.70	200.00	90.50	60.00	●
28,500	285	28.50 - 28.99	32.00	28.20	202.00	92.50	60.00	●
28,505	285	28.50 - 28.99	31.75	28.20	202.00	92.50	60.00	●
29,000	290	29.00 - 29.49	32.00	28.70	205.00	94.60	60.00	●
29,005	290	29.00 - 29.49	31.75	28.70	205.00	94.60	60.00	●
29,500	295	29.50 - 29.99	32.00	29.20	207.00	95.10	60.00	●
29,505	295	29.50 - 29.99	31.75	29.20	207.00	95.10	60.00	●
30,000	300	30.00 - 30.49	32.00	29.70	210.00	96.70	60.00	●
30,005	300	30.00 - 30.49	31.75	29.70	210.00	96.70	60.00	●
30,500	305	30.50 - 30.99	32.00	30.20	212.00	98.30	60.00	●
30,505	305	30.50 - 30.99	31.75	30.20	212.00	98.30	60.00	●
31,000	310	31.00 - 31.49	32.00	30.70	214.00	99.80	60.00	●
31,005	310	31.00 - 31.49	31.75	30.70	214.00	99.80	60.00	●
31,500	315	31.50 - 31.99	32.00	31.20	216.00	101.40	60.00	●
31,505	315	31.50 - 31.99	31.75	31.20	216.00	101.40	60.00	●

Holders are always supplied with clamping screw, Guhring no. 4071, and screwdriver, Guhring no. 1612.







Order no. = Guhring no. + Code-no.

Guhring no.  
Discount group

4108

140

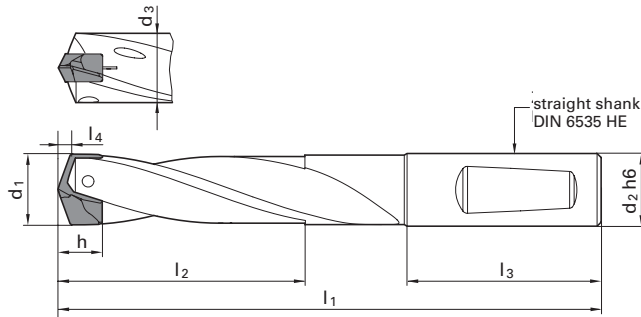

\*l1 with drilling insert Guhring no. 4112, 4113, 4114 or 4115 only.  
With pilot insert Guhring no. 4111, see h and l4 dimensions page 11 to 13!



Availability

Code no.	Holder size	d1 mm	d2h6 mm	d3 mm	incl. WP l1* mm	l2 max mm	l3 mm	Availability
32,000	320	32.00 - 32.99	32.00	31.70	287.00	170.60	60.00	●
32,005	320	32.00 - 32.99	31.75	31.70	287.00	170.60	60.00	●
33,000	330	33.00 - 33.99	32.00	32.70	294.00	175.80	60.00	●
33,005	330	33.00 - 33.99	31.75	32.70	294.00	175.80	60.00	●
34,000	340	34.00 - 34.99	32.00	33.70	300.00	181.00	60.00	●
34,005	340	34.00 - 34.99	31.75	33.70	300.00	181.00	60.00	●
35,000	350	35.00 - 35.99	32.00	34.70	307.00	186.20	60.00	●
35,005	350	35.00 - 35.99	31.75	34.70	307.00	186.20	60.00	●
36,000	360	36.00 - 36.99	32.00	35.70	314.00	191.30	60.00	●
36,005	360	36.00 - 36.99	31.75	35.70	314.00	191.30	60.00	●
37,000	370	37.00 - 37.99	32.00	36.70	321.00	196.50	60.00	●
37,005	370	37.00 - 37.99	31.75	36.70	321.00	196.50	60.00	●
38,000	380	38.00 - 38.99	32.00	37.70	327.00	201.70	60.00	●
38,005	380	38.00 - 38.99	31.75	37.70	327.00	201.70	60.00	●
39,000	390	39.00 - 40.00	32.00	38.70	334.00	206.90	60.00	●
39,005	390	39.00 - 40.00	31.75	38.70	334.00	206.90	60.00	●

Holders are always supplied with clamping screw, Guhring no. 4071, and screwdriver, Guhring no. 1612.





# HT 800 WP Interchangeable Insert holders 7 x D

Guhring no.

Discount group

4109

140

Order no. = Guhring no. + Code-no.

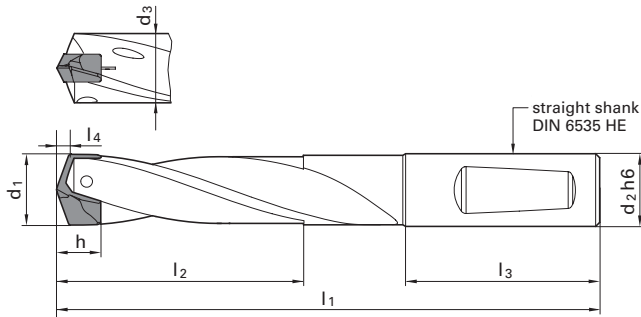

\*l1 with drilling insert Guhring no. 4112, 4113, 4114 or 4115 only.  
With pilot insert Guhring no. 4111, see h and l4 dimensions page 11 to 13!



Availability

Code no.	Holder size	d1 mm	d2h6 mm	d3 mm	incl. WP l1* mm	l2 max mm	l3 mm	Availability
21,500	215	21.50 - 21.99	25.00	21.20	251.00	158.10	56.00	●
21,505	215	21.50 - 21.99	25.40	21.20	251.00	158.10	56.00	●
22,000	220	22.00 - 22.49	25.00	21.70	255.00	161.70	56.00	●
22,005	220	22.00 - 22.49	25.40	21.70	255.00	161.70	56.00	●
22,500	225	22.50 - 22.99	25.00	22.20	260.00	165.30	56.00	●
22,505	225	22.50 - 22.99	25.40	22.20	260.00	165.30	56.00	●
23,000	230	23.00 - 23.49	25.00	22.70	264.00	168.90	56.00	●
23,005	230	23.00 - 23.49	25.40	22.70	264.00	168.90	56.00	●
23,500	235	23.50 - 23.99	25.00	23.20	269.00	172.50	56.00	●
23,505	235	23.50 - 23.99	25.40	23.20	269.00	172.50	56.00	●
24,000	240	24.00 - 24.49	25.00	23.70	273.00	176.10	56.00	●
24,005	240	24.00 - 24.49	25.40	23.70	273.00	176.10	56.00	●
24,500	245	24.50 - 24.99	25.00	24.20	277.00	179.70	56.00	●
24,505	245	24.50 - 24.99	25.40	24.20	277.00	179.70	56.00	●
25,000	250	25.00 - 25.49	25.00	24.70	282.00	183.30	56.00	●
25,005	250	25.00 - 25.49	25.40	24.70	282.00	183.30	56.00	●
25,500	255	25.50 - 25.99	32.00	25.20	291.00	186.90	60.00	●
25,505	255	25.50 - 25.99	31.75	25.20	291.00	186.90	60.00	●
26,000	260	26.00 - 26.49	32.00	25.70	297.00	190.00	60.00	●
26,005	260	26.00 - 26.49	31.75	25.70	297.00	190.00	60.00	●
26,500	265	26.50 - 26.99	32.00	26.20	301.00	194.00	60.00	●
26,505	265	26.50 - 26.99	31.75	26.20	301.00	194.00	60.00	●
27,000	270	27.00 - 27.49	32.00	26.70	306.00	197.20	60.00	●
27,005	270	27.00 - 27.49	31.75	26.70	306.00	197.20	60.00	●
27,500	275	27.50 - 27.99	32.00	27.20	310.00	200.80	60.00	●
27,505	275	27.50 - 27.99	31.75	27.20	310.00	200.80	60.00	●
28,000	280	28.00 - 28.49	32.00	27.70	314.00	204.40	60.00	●
28,005	280	28.00 - 28.49	31.75	27.70	314.00	204.40	60.00	●
28,500	285	28.50 - 28.99	32.00	28.20	318.00	208.40	60.00	●
28,505	285	28.50 - 28.99	31.75	28.20	318.00	208.40	60.00	●
29,000	290	29.00 - 29.49	32.00	28.70	323.00	212.50	60.00	●
29,005	290	29.00 - 29.49	31.75	28.70	323.00	212.50	60.00	●
29,500	295	29.50 - 29.99	32.00	29.20	327.00	215.10	60.00	●
29,505	295	29.50 - 29.99	31.75	29.20	327.00	215.10	60.00	●
30,000	300	30.00 - 30.49	32.00	29.70	332.00	218.60	60.00	●
30,005	300	30.00 - 30.49	31.75	29.70	332.00	218.60	60.00	●
30,500	305	30.50 - 30.99	32.00	30.20	336.00	222.20	60.00	●
30,505	305	30.50 - 30.99	31.75	30.20	336.00	222.20	60.00	●
31,000	310	31.00 - 31.49	32.00	30.70	340.00	225.80	60.00	●
31,005	310	31.00 - 31.49	31.75	30.70	340.00	225.80	60.00	●
31,500	315	31.50 - 31.99	32.00	31.20	344.00	229.40	60.00	●
31,505	315	31.50 - 31.99	31.75	31.20	344.00	229.40	60.00	●

Holders are always supplied with clamping screw, Guhring no. 4071, and screwdriver, Guhring no. 1612.

HT 800 WP Interchangeable Insert Holders 10 x D

Order no. = Guhring no. + Code-no.

Guhring no.

Discount group

4110

140

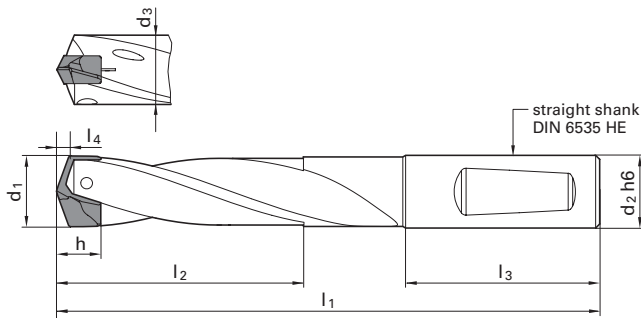

\*l1 with drilling insert Guhring no. 4112, 4113, 4114 or 4115 only.  
With pilot insert Guhring no. 4111, see h and l4 dimensions page 11 to 13!



Code no.	Holder size	d1 mm	d2h6 mm	d3 mm	incl. WP l1* mm	l2 max mm	l3 mm	Availability
11,000	110	11.00 - 11.49	12.00	10.70	182.00	117.10	45.00	●
11,005	110	11.00 - 11.49	12.70	10.70	182.00	117.10	45.00	●
11,500	115	11.50 - 11.99	12.00	11.20	187.00	122.10	45.00	●
11,505	115	11.50 - 11.99	12.70	11.20	187.00	122.10	45.00	●
12,000	120	12.00 - 12.49	12.00	11.70	194.00	127.20	45.00	●
12,005	120	12.00 - 12.49	12.70	11.70	194.00	127.20	45.00	●
12,500	125	12.50 - 12.99	14.00	12.20	199.00	132.30	45.00	●
12,505	125	12.50 - 12.99	15.875	12.20	199.00	132.30	45.00	●
13,000	130	13.00 - 13.49	14.00	12.70	205.00	137.50	45.00	●
13,005	130	13.00 - 13.49	15.875	12.70	205.00	137.50	45.00	●
13,500	135	13.50 - 13.99	14.00	13.20	211.00	142.50	45.00	●
13,505	135	13.50 - 13.99	15.875	13.20	211.00	142.50	45.00	●
14,000	140	14.00 - 14.49	14.00	13.70	217.00	147.70	45.00	●
14,005	140	14.00 - 14.49	15.875	13.70	217.00	147.70	45.00	●
14,500	145	14.50 - 14.99	16.00	14.20	225.00	152.80	48.00	●
14,505	145	14.50 - 14.99	15.875	14.20	225.00	152.80	48.00	●
15,000	150	15.00 - 15.49	16.00	14.70	232.00	157.80	48.00	●
15,005	150	15.00 - 15.49	15.875	14.70	232.00	157.80	48.00	●
15,500	155	15.50 - 15.99	16.00	15.20	237.00	162.90	48.00	●
15,505	155	15.50 - 15.99	15.875	15.20	237.00	162.90	48.00	●
16,000	160	16.00 - 16.49	16.00	15.70	243.00	168.00	48.00	●
16,005	160	16.00 - 16.49	15.875	15.70	243.00	168.00	48.00	●
16,500	165	16.50 - 16.99	18.00	16.20	249.00	173.10	48.00	●
16,505	165	16.50 - 16.99	19.05	16.20	249.00	173.10	48.00	●
17,000	170	17.00 - 17.49	18.00	16.70	255.00	178.30	48.00	●
17,005	170	17.00 - 17.49	19.05	16.70	255.00	178.30	48.00	●
17,500	175	17.50 - 17.99	18.00	17.20	260.00	183.50	48.00	●
17,505	175	17.50 - 17.99	19.05	17.20	260.00	183.50	48.00	●
18,000	180	18.00 - 18.49	18.00	17.70	267.00	188.40	48.00	●
18,005	180	18.00 - 18.49	19.05	17.70	267.00	188.40	48.00	●
18,500	185	18.50 - 18.99	20.00	18.20	274.00	193.50	50.00	●
18,505	185	18.50 - 18.99	19.05	18.20	274.00	193.50	50.00	●
19,000	190	19.00 - 19.49	20.00	18.70	280.00	198.70	50.00	●
19,005	190	19.00 - 19.49	19.05	18.70	280.00	198.70	50.00	●
19,500	195	19.50 - 19.99	20.00	19.20	286.00	203.70	50.00	●
19,505	195	19.50 - 19.99	19.05	19.20	286.00	203.70	50.00	●

Holders are always supplied with clamping screw, Guhring no. 4071, and screwdriver, Guhring no. 1612



Order no. = Guhring no. + Code-no.

Guhring no.

Discount group

4110

140

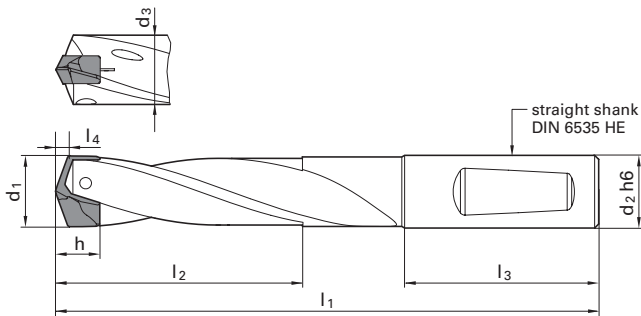

\*l1 with drilling insert Guhring no. 4112, 4113, 4114 or 4115 only.  
With pilot insert Guhring no. 4111, see h and l4 dimensions page 11 to 13!





Code no.	Holder size	d1 mm	d2h6 mm	d3 mm	incl. WP l1* mm	l2 max mm	l3 mm
29,000	290	29.00 - 29.49	32.00	28.70	412.00	300.50	60.00
29,005	290	29.00 - 29.49	31.75	28.70	412.00	300.50	60.00
29,500	295	29.50 - 29.99	32.00	29.20	418.00	305.60	60.00
29,505	295	29.50 - 29.99	31.75	29.20	418.00	305.60	60.00
30,000	300	30.00 - 30.49	32.00	29.70	424.00	310.60	60.00
30,005	300	30.00 - 30.49	31.75	29.70	424.00	310.60	60.00
30,500	305	30.50 - 30.99	32.00	30.20	429.00	315.70	60.00
30,505	305	30.50 - 30.99	31.75	30.20	429.00	315.70	60.00
31,000	310	31.00 - 31.49	32.00	30.70	435.00	320.80	60.00
31,005	310	31.00 - 31.49	31.75	30.70	435.00	320.80	60.00
31,500	315	31.50 - 31.99	32.00	31.20	441.00	325.90	60.00
31,505	315	31.50 - 31.99	31.75	31.20	441.00	325.90	60.00

Availability
●
●
●
●
●
●
●
●
●
●
●
●
●

Holders are always supplied with clamping screw, Guhring no. 4071, and screwdriver, Guhring no. 1612

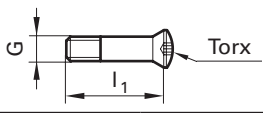
## Clamping screws

Order no. = Guhring no. + Code-no.					Guhring no.	
Code no.	Holder size	G	l1 mm	Discount group	with Torx	
2,200	110/115	M2.2	9.50	T7	●	
2,201	120/125	M2.2	10.50	T7	●	
2,500	130/135	M2.5	11.40	T8	●	
3,000	140/145	M3	12.10	T9	●	
3,001	150/155	M3	13.10	T9	●	
3,500	160 - 175	M3.5	14.25	T10	●	
4,000	180 - 195	M4	16.00	T15	●	
4,500	200 - 215	M4.5	18.00	T15	●	
5,000	220 - 235	M5	19.75	T20	●	
5,001	240 - 255	M5	21.75	T20	●	
5,003	260 - 295	M5	23.40	T20	●	
6,000	300 - 315	M6	27.00	T25	●	
6,001	320 - 350	M6	28.50	T25	●	
6,002	360 - 390	M6	32.50	T25	●	

## Screwdriver





Order no. = Guhring no. + Code-no.				Guhring no.	<b>1612</b> 140
Code no.	Holder size	for Torx		Discount group	
6,000	Pilot holder 110 - 140	T6			●
7,000	Pilot holder 160 - 280	T7			●
7,001	110 - 125	T7			●
8,001	130/135	T8			●
9,001	140 - 155	T9			●
10,001	160 - 175	T10			●
15,000	Pilot holder 300 - 360	T15			●
15,001	180 - 215	T15			●
20,001	220 - 295	T20			●
25,001	300 - 390	T25			●

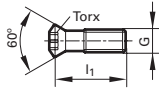









## Clamping screws

Order no. = Guhring no. + Code-no.					Guhring no.	6128
					Discount group	122
						
Code no.	Holder size	G	l1 mm	with Torx	Availability	
2,000	110 - 140	M2.0	5.50	T6	●	
2,500	160 - 280	M2.5	5.30	T7	●	
4,006	300 - 360	M4	9.50	T15	●	

## Torque key

Order no. = Guhring no. + Code-no.					Guhring no.	4915
					Discount group	114
						
Code no.	Type	Drive	l1 mm	Torque Nm	Availability	
2,000	A	1/4" 	160.00	0.8...2	●	
8,000	A	1/4" 	160.00	2...8	●	
14,000	A	1/4" 	200.00	5...14	●	

## Torx-Bits

Order no. = Guhring no. + Code-no.				Guhring no.	4917
				Discount group	140
					
Code no.	for Torx	Drive	l1 mm	Availability	
7,000	T7	1/4" 	25	●	
8,000	T8	1/4" 	25	●	
9,000	T9	1/4" 	25	●	
10,000	T10	1/4" 	25	●	
15,000	T15	1/4" 	25	●	
20,000	T20	1/4" 	25	●	
25,001	T25	1/4" 	25	●	

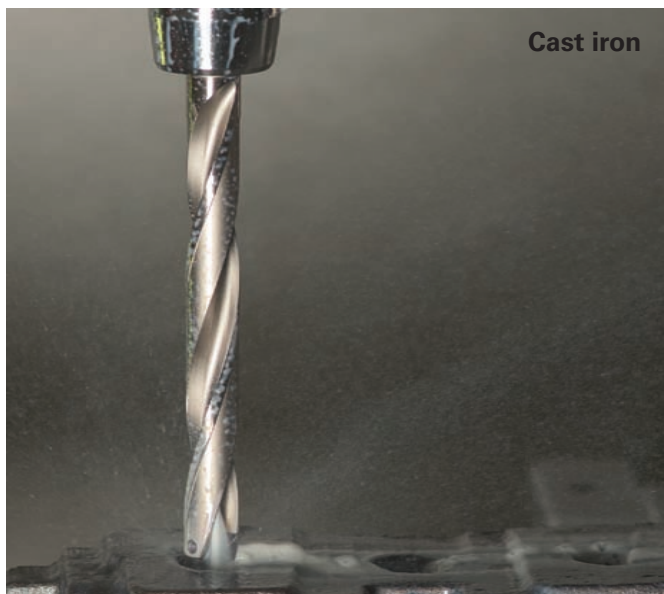

Cast iron



Aluminium

# HT 800 WP Application Recommendations

All data are approximate values. The actually achievable cutting speeds and feed rates depend on the respective machining conditions. We recommend suitable drilling trials.

For selecting the optimal tool and the recommended cutting parameters for your application there is also an electronic version of GühringNavigator available at [www.guehring.de](http://www.guehring.de)

- for through holes supporting lands must remain in permanent contact.
- don't apply drilling tool without trial for interrupted cutting (grooves, transverse holes). For interrupted cutting (max. 0.2xD) it is recommended to reduce the feed rate whenever possible.
- in contrast to conventional indexable inserts, HT 800 tools are also suitable for the drilling of stacked sheets.
- on a lathe (stationary tool) it must be ensured that the tool is accurately centred.
- pre-condition for optimal machining results is a sufficient cooling lubricant supply with soluble or neat oil.
- the tool is only of limited suitability for dry machining or MQL. For MQL application we recommend the use of the conical MQL shank end as well as Gühring MQL components. Please contact our Sales Management.

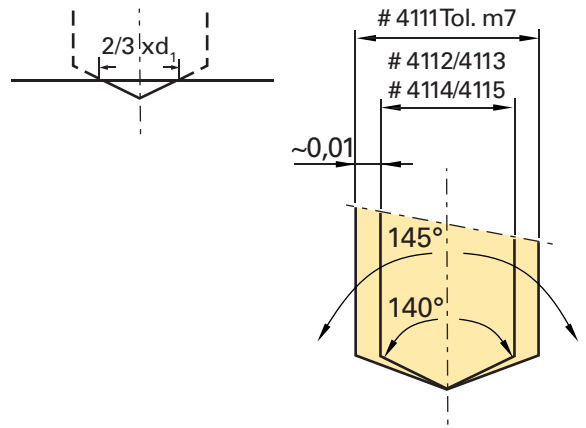

Drill-Ø mm	Feed column no.								
	1	2	3	4	5	6	7	8	9
	f (mm/rev.)								
0.50	0.004	0.006	0.007	0.008	0.010	0.012	0.014	0.016	0.019
1.00	0.006	0.008	0.012	0.014	0.016	0.018	0.020	0.023	0.025
2.00	0.020	0.025	0.032	0.040	0.050	0.063	0.080	0.100	0.125
2.50	0.025	0.032	0.040	0.050	0.063	0.080	0.100	0.125	0.160
3.15	0.032	0.040	0.050	0.063	0.080	0.100	0.125	0.160	0.160
4.00	0.040	0.050	0.063	0.080	0.100	0.125	0.160	0.200	0.200
5.00	0.040	0.050	0.063	0.080	0.100	0.125	0.160	0.200	0.250
6.30	0.050	0.063	0.080	0.100	0.125	0.160	0.200	0.250	0.315
8.00	0.063	0.080	0.100	0.125	0.160	0.200	0.250	0.315	0.315
10.00	0.080	0.100	0.125	0.160	0.200	0.250	0.315	0.400	0.400
12.50	0.080	0.100	0.125	0.160	0.200	0.250	0.315	0.400	0.500
16.00	0.100	0.125	0.160	0.200	0.250	0.315	0.400	0.500	0.630
20.00	0.125	0.160	0.200	0.250	0.315	0.400	0.500	0.630	0.630
25.00	0.160	0.200	0.250	0.315	0.400	0.500	0.630	0.800	0.800
31.50	0.160	0.200	0.250	0.315	0.400	0.500	0.630	0.800	1.000
40.00	0.200	0.250	0.315	0.400	0.500	0.630	0.800	1.000	1.250

Coolant:





- air
- neat oil
- soluble oil

Material group	Material examples, new description (old description in brackets) Figures in bold = material no. to DIN EN	Tensile strength MPa (N/mm <sup>2</sup> )	Hard- ness	Cool- ant
Common structural steels	<b>1.0035</b> S185(St33), <b>1.0486</b> P275N(StE285), <b>1.0345</b> P235GH(H1), <b>1.0425</b> P265GH(H2) <b>1.0050</b> E295 (St50-2), <b>1.0070</b> E360 (St70-2), <b>1.8937</b> P500NH (WStE500)	≤500 >500-850		●
Free-cutting steels	<b>1.0718</b> 11SMnPb30 (9SMnPb28), <b>1.0736</b> 11SMn37 (9SMn36) <b>1.0727</b> 46S20 (45S20), <b>1.0728</b> (60S20), <b>1.0757</b> 46SPb20 (45SPb20)	≤850 850-1000		●
Unalloyed heat-treatable steels	<b>1.0402</b> C22, <b>1.1178</b> C30E (Ck30) <b>1.0503</b> C45, <b>1.1191</b> C45E (Ck45) <b>1.0601</b> C60, <b>1.1221</b> C60E (Ck60)	≤ 700 700-850 850-1000		●
Alloyed heat-treatable steels	<b>1.5131</b> 50MnSi4, <b>1.7003</b> 38Cr2, <b>1.7030</b> 28Cr4 <b>1.5710</b> 36NiCr6, <b>1.7035</b> 41Cr4, <b>1.7225</b> 42CrMo4	850-≤1000 1000-1200		●
Unalloyed case hardened steels	<b>1.0301</b> (C10), <b>1.1121</b> C10E (Ck10)	≤750		●
Alloyed case hardened steels	<b>1.7043</b> 38Cr4 <b>1.5752</b> 15NiCr13 (15NiCr13), <b>1.7131</b> 16MnCr5, <b>1.7264</b> 20CrMo5	850-≤1000 1000-1200		●
Nitriding steels	<b>1.8504</b> 34CrAl6 <b>1.8519</b> 31CrMoV9, <b>1.8550</b> 34CrAlNi7	≥850-≤1000 >1000-1200		●
Tool steels	<b>1.1750</b> C75W, <b>1.2067</b> 102Cr6, <b>1.2307</b> 29CrMoV9 <b>1.2080</b> X210Cr12, <b>1.2083</b> X42Cr13, <b>1.2419</b> 105WCr6, <b>1.2767</b> X45NiCrMo4	≤850 >850-1000		●
High speed steels	<b>1.3243</b> S 6-5-2-5, <b>1.3343</b> S 6-5-2, <b>1.3344</b> S 6-5-3	≥650-1000		●
Spring steels	<b>1.5026</b> 55Si7, <b>1.7176</b> 55Cr3, <b>1.8159</b> 51CrV4 (51CrV4)		≤330 HB	●
Stainless steels, sulphured austenitic martensitic	<b>1.4005</b> X12CrS13, <b>1.4104</b> X14CrMoS17, <b>1.4105</b> X6CrMoS17, <b>1.4305</b> X8CrNiS18-9 <b>1.4301</b> X5CrNi18-10 (V2A), <b>1.4541</b> X6CrNiTi18-10, <b>1.4571</b> X6CrNiMoTi 17-12-2 (V4A) <b>1.4057</b> X20CrNi 17 2 (X17CrNi16-2), <b>1.4122</b> X39CrMo17-1, <b>1.4521</b> X2CrMoTi18-2	≤850 ≤850 ≤850		●
Hardened steels	-		≤40-48 HRC >48-60 HRC	●
Special alloys	Nimonic, Inconel, Monel, Hastelloy	≤1200		●
Cast iron	<b>0.6010</b> EN-GJL-100(GG10), <b>0.6020</b> EN-GJL-200(GG20) <b>0.6025</b> EN-GJL-250(GG25), <b>0.6035</b> EN-GJL-350(GG35)		≤240 HB <300 HB	●
New cast materials CGI	<b>EN-GJV250</b> (GGV25), <b>EN-GJV350</b> (GGV35) <b>EN-GJV400</b> (GGV40), <b>EN-GJV500</b> (GGV50), SiMo 6		≤220 HB <300 HB	●
New cast materials ADI	<b>EN-GJS-800-8</b> (ADI800), <b>EN-GJS-1000-5</b> (ADI1000) <b>EN-GJS-1200-2</b> (ADI1200), <b>EN-GJS-1400-1</b> (ADI1400)	800-1000 1200-1400		●
Spheroidal graphite iron and malleable cast iron	<b>0.7050</b> EN-GJS-500-7(GGG50), <b>0.8035</b> EN-GJMW-350-4(GTW35) <b>0.7070</b> EN-GJS-700-2(GGG70), <b>0.8170</b> EN-GJMB-700-2(GTS70)		≤240 HB <300 HB	●
Chilled cast iron	-		≤350 HB	●
Ti and Ti-alloys	<b>3.7024</b> Ti99,5, <b>3.7114</b> TiAl5Sn2,5, <b>3.7124</b> TiCu2 <b>3.7154</b> TiAl6Zr5, <b>3.7165</b> TiAl6V4, <b>3.7184</b> TiAl4Mo4Sn2,5, -TiAl8Mo1V1	≤850 >850-1200		●
Aluminium and Al-alloys	<b>3.0255</b> Al99,5, <b>3.2315</b> AlMgSi1, <b>3.3515</b> AlMg1		≤400	●
Al wrought alloys	<b>3.0615</b> AlMgSiPb, <b>3.1325</b> AlCuMg1, <b>3.3245</b> AlMg3Si, <b>3.4365</b> AlZnMgCu1,5		≤450	●
Al cast alloys ≤ 10 % Si > 10 % Si	<b>3.2131</b> G-AlSi5Cu1, <b>3.2153</b> G-AlSi7Cu3, <b>3.2573</b> G-AlSi9 <b>3.2581</b> G-AlSi12, <b>3.2583</b> G-AlSi12Cu, - G-AlSi12CuNiMg		≤600 ≤600	●
Magnesium alloys	<b>3.5200</b> MgMn2, <b>3.5812.05</b> G-MgAl8Zn1, <b>3.5612.05</b> G-MgAl6Zn1		≤450	○
Copper, low-alloyed	<b>2.0070</b> SE-Cu, <b>2.1020</b> CuSn6, <b>2.1096</b> G-CuSn5ZnPb		≤400	●
Brass, short-chipping long-chipping	<b>2.0380</b> CuZn39Pb2, <b>2.0401</b> CuZn39Pb3, <b>2.0410</b> CuZn43Pb2 <b>2.0250</b> CuZn20, <b>2.0280</b> CuZn33, <b>2.0332</b> CuZn37Pb0,5		≤600 ≤600	●
Bronze, short-chipping	<b>2.1090</b> CuSn7ZnPb, <b>2.1170</b> CuPb5Sn5, <b>2.1176</b> CuPb10Sn <b>2.0790</b> CuNi18Zn19Pb		≤600 >600-850	●
Bronze, long-chipping	<b>2.0916</b> CuAl5, <b>2.0960</b> CuAl9Mn, <b>2.1050</b> CuSn10 <b>2.0980</b> CuAl11Ni, <b>2.1247</b> CuBe2		≤850 >850-1000	●



## Tool holders $\leq 1 \times D$ , Guhring no. 4105 for pilot drilling/countersinking



Guhring no.	4111	4112	4115	4113	4114			
Tool material	Solid carbide	Solid carbide	Solid carbide	Solid carbide	Solid carbide			
Carbide grade	K/P	K/P	K/P	K/P	K			
Surface finish	nanoA	nanoFIRE	nanoA	FIRE	bright			
Application	pilot drilling/countersinking	steel	stainless steel	cast iron	Al and Al-alloys			
								
$V_c$ m/min	Feed column no.	$V_c$ m/min	Feed column no.	$V_c$ m/min	Feed column no.	$V_c$ m/min	Feed column no.	
130	6	130	6					
110	5	110	5					
130	7	130	7					
110	6	110	6					
130	6	130	6					
125	6	125	6					
110	5	110	5					
110	6	110	6					
90	5	90	5					
130	7	130	7					
110	6	110	6					
70	4	70	4					
105	5	105	5					
70	4	70	4					
60	5	60	5					
55	4	55	4					
55	3	55	3					
50	2	50	2					
55	3			55	3			
40	3			40	3			
35	3			35	3			
25	2			25	2			
25	2			25	2			
100	6					100	6	
90	6					90	6	
80	5					80	5	
80	5					80	5	
80	5					80	5	
80	5					80	5	
120	7					120	7	
100	6					100	6	
90	6			90	6			
40	3			40	3			
35	2			35	2			
200	7						200	7
180	7						180	7
150	7						150	7
120	7						120	7
180	7						180	7
70	6						70	6
180	7						180	7
120	6						120	6
70	6						70	6
50	6						50	6
45	6						45	6
35	5						35	5

## HT 800 WP Application Recommendations

All data are approximate values. The actually achievable cutting speeds and feed rates depend on the respective machining conditions. We recommend suitable drilling trials.

For selecting the optimal tool and the recommended cutting parameters for your application there is also an electronic version of GühringNavigator available at [www.guehring.de](http://www.guehring.de)

- for through holes supporting lands must remain in permanent contact.
- don't apply drilling tool without trial for interrupted cutting (grooves, transverse holes). For interrupted cutting (max. 0.2xD) it is recommended to reduce the feed rate whenever possible.
- in contrast to conventional indexable inserts, HT 800 tools are also suitable for the drilling of stacked sheets.
- on a lathe (stationary tool) it must be ensured that the tool is accurately centred.
- pre-condition for optimal machining results is a sufficient cooling lubricant supply with soluble or neat oil.
- the tool is only of limited suitability for dry machining or MQL. For MQL application we recommend the use of the conical MQL shank end as well as Gühring MQL components. Please contact our Sales Management.





Drill-Ø mm	Feed column no.								
	1	2	3	4	5	6	7	8	9
	f (mm/rev.)								
0.50	0.004	0.006	0.007	0.008	0.010	0.012	0.014	0.016	0.019
1.00	0.006	0.008	0.012	0.014	0.016	0.018	0.020	0.023	0.025
2.00	0.020	0.025	0.032	0.040	0.050	0.063	0.080	0.100	0.125
2.50	0.025	0.032	0.040	0.050	0.063	0.080	0.100	0.125	0.160
3.15	0.032	0.040	0.050	0.063	0.080	0.100	0.125	0.160	0.160
4.00	0.040	0.050	0.063	0.080	0.100	0.125	0.160	0.200	0.200
5.00	0.040	0.050	0.063	0.080	0.100	0.125	0.160	0.200	0.250
6.30	0.050	0.063	0.080	0.100	0.125	0.160	0.200	0.250	0.315
8.00	0.063	0.080	0.100	0.125	0.160	0.200	0.250	0.315	0.315
10.00	0.080	0.100	0.125	0.160	0.200	0.250	0.315	0.400	0.400
12.50	0.080	0.100	0.125	0.160	0.200	0.250	0.315	0.400	0.500
16.00	0.100	0.125	0.160	0.200	0.250	0.315	0.400	0.500	0.630
20.00	0.125	0.160	0.200	0.250	0.315	0.400	0.500	0.630	0.630
25.00	0.160	0.200	0.250	0.315	0.400	0.500	0.630	0.800	0.800
31.50	0.160	0.200	0.250	0.315	0.400	0.500	0.630	0.800	1.000
40.00	0.200	0.250	0.315	0.400	0.500	0.630	0.800	1.000	1.250

Coolant:  
 ○ air  
 ● neat oil  
 ● soluble oil

Material group	Material examples, <b>new description</b> (old description in brackets) Figures in bold = material no. to DIN EN	Tensile strength MPa (N/mm <sup>2</sup> )	Hard- ness	Cool- ant
Common structural steels	<b>1.0035</b> S185(St33), <b>1.0486</b> P275N(StE285), <b>1.0345</b> P235GH(H1), <b>1.0425</b> P265GH(H2) <b>1.0050</b> E295 (St50-2), <b>1.0070</b> E360 (St70-2), <b>1.8937</b> P500NH (WStE500)	≤500 >500-850		●
Free-cutting steels	<b>1.0718</b> 11SMnPb30 (9SMnPb28), <b>1.0736</b> 11SMn37 (9SMn36) <b>1.0727</b> 46S20 (45S20), <b>1.0728</b> (60S20), <b>1.0757</b> 46SPb20 (45SPb20)	≤850 850-1000		●
Unalloyed heat-treatable steels	<b>1.0402</b> C22, <b>1.1178</b> C30E (Ck30) <b>1.0503</b> C45, <b>1.1191</b> C45E (Ck45) <b>1.0601</b> C60, <b>1.1221</b> C60E (Ck60)	≤ 700 700-850 850-1000		●
Alloyed heat-treatable steels	<b>1.5131</b> 50MnSi4, <b>1.7003</b> 38Cr2, <b>1.7030</b> 28Cr4 <b>1.5710</b> 36NiCr6, <b>1.7035</b> 41Cr4, <b>1.7225</b> 42CrMo4	850-≤1000 1000-1200		●
Unalloyed case hardened steels	<b>1.0301</b> (C10), <b>1.1121</b> C10E (Ck10)	≤750		●
Alloyed case hardened steels	<b>1.7043</b> 38Cr4 <b>1.5752</b> 15NiCr13 (15NiCr13), <b>1.7131</b> 16MnCr5, <b>1.7264</b> 20CrMo5	850-≤1000 1000-1200		●
Nitriding steels	<b>1.8504</b> 34CrAl6 <b>1.8519</b> 31CrMoV9, <b>1.8550</b> 34CrAlNi7	≥850-≤1000 >1000-1200		●
Tool steels	<b>1.1750</b> C75W, <b>1.2067</b> 102Cr6, <b>1.2307</b> 29CrMoV9 <b>1.2080</b> X210Cr12, <b>1.2083</b> X42Cr13, <b>1.2419</b> 105WCr6, <b>1.2767</b> X45NiCrMo4	≤850 >850-1000		●
High speed steels	<b>1.3243</b> S 6-5-2-5, <b>1.3343</b> S 6-5-2, <b>1.3344</b> S 6-5-3	≥650-1000		●
Spring steels	<b>1.5026</b> 55Si7, <b>1.7176</b> 55Cr3, <b>1.8159</b> 51CrV4 (51CrV4)		≤330 HB	●
Stainless steels, sulphured austenitic martensitic	<b>1.4005</b> X12CrS13, <b>1.4104</b> X14CrMoS17, <b>1.4105</b> X6CrMoS17, <b>1.4305</b> X8CrNiS18-9 <b>1.4301</b> X5CrNi18-10 (V2A), <b>1.4541</b> X6CrNiTi18-10, <b>1.4571</b> X6CrNiMoTi 17-12-2 (V4A) <b>1.4057</b> X20CrNi 172 (X17CrNi16-2), <b>1.4122</b> X39CrMo17-1, <b>1.4521</b> X2CrMoTi18-2	≤850 ≤850 ≤850		●
Hardened steels	-		≤40-48 HRC >48-60 HRC	●
Special alloys	Nimonic, Inconel, Monel, Hastelloy	≤1200		●
Cast iron	<b>0.6010</b> EN-GJL-100(GG10), <b>0.6020</b> EN-GJL-200(GG20) <b>0.6025</b> EN-GJL-250(GG25), <b>0.6035</b> EN-GJL-350(GG35)		≤240 HB <300 HB	●
New cast materials CGI	<b>EN-GJV250</b> (GGV25), <b>EN-GJV350</b> (GGV35) <b>EN-GJV400</b> (GGV40), <b>EN-GJV500</b> (GGV50), SiMo 6		≤220 HB <300 HB	●
New cast materials ADI	<b>EN-GJS-800-8</b> (ADI800), <b>EN-GJS-1000-5</b> (ADI1000) <b>EN-GJS-1200-2</b> (ADI1200), <b>EN-GJS-1400-1</b> (ADI1400)	800-1000 1200-1400		●
Spheroidal graphite iron and malleable cast iron	<b>0.7050</b> EN-GJS-500-7(GGG50), <b>0.8035</b> EN-GJMW-350-4(GTW35) <b>0.7070</b> EN-GJS-700-2(GGG70), <b>0.8170</b> EN-GJMB-700-2(GTS70)		≤240 HB <300 HB	●
Chilled cast iron	-		≤350 HB	●
Ti and Ti-alloys	<b>3.7024</b> Ti99,5, <b>3.7114</b> TiAl5Sn2,5, <b>3.7124</b> TiCu2 <b>3.7154</b> TiAl6Zr5, <b>3.7165</b> TiAl6V4, <b>3.7184</b> TiAl4Mo4Sn2,5, -TiAl8Mo1V1	≤850 >850-1200		●
Aluminium and Al-alloys	<b>3.0255</b> Al99,5, <b>3.2315</b> AlMgSi1, <b>3.3515</b> AlMg1		≤400	●
Al wrought alloys	<b>3.0615</b> AlMgSiPb, <b>3.1325</b> AlCuMg1, <b>3.3245</b> AlMg3Si, <b>3.4365</b> AlZnMgCu1,5		≤450	●
Al cast alloys ≤ 10 % Si > 10 % Si	<b>3.2131</b> G-AlSi5Cu1, <b>3.2153</b> G-AlSi7Cu3, <b>3.2573</b> G-AlSi9 <b>3.2581</b> G-AlSi12, <b>3.2583</b> G-AlSi12Cu, - G-AlSi12CuNiMg		≤600 ≤600	●
Magnesium alloys	<b>3.5200</b> MgMn2, <b>3.5812.05</b> G-MgAl8Zn1, <b>3.5612.05</b> G-MgAl6Zn1		≤450	○
Copper, low-alloyed	<b>2.0070</b> SE-Cu, <b>2.1020</b> CuSn6, <b>2.1096</b> G-CuSn5ZnPb		≤400	●
Brass, short-chipping long-chipping	<b>2.0380</b> CuZn39Pb2, <b>2.0401</b> CuZn39Pb3, <b>2.0410</b> CuZn43Pb2 <b>2.0250</b> CuZn20, <b>2.0280</b> CuZn33, <b>2.0332</b> CuZn37Pb0,5		≤600 ≤600	●
Bronze, short-chipping	<b>2.1090</b> CuSn7ZnPb, <b>2.1170</b> CuPb5Sn5, <b>2.1176</b> CuPb10Sn <b>2.0790</b> CuNi18Zn19Pb		≤600 >600-850	●
Bronze, long-chipping	<b>2.0916</b> CuAl5, <b>2.0960</b> CuAl9Mn, <b>2.1050</b> CuSn10 <b>2.0980</b> CuAl11Ni, <b>2.1247</b> CuBe2		≤850 >850-1000	●

## Tool holders $\leq 1.5 \times D$ , Guhring no. 4106



Guhring no.	4112	4115	4113	4114	
	Tool material Carbide grade Surface finish Application	<b>Solid carbide</b> K/P nanoFIRE steel	<b>Solid carbide</b> K/P nanoA stainless steel	<b>Solid carbide</b> K/P FIRE cast iron	<b>Solid carbide</b> K bright Al and Al-alloys
					
$V_c$ m/min	Feed column no.	$V_c$ m/min	Feed column no.	$V_c$ m/min	Feed column no.
130	6				
110	5				
130	7				
110	6				
130	6				
125	6				
110	5				
110	6				
90	5				
130	7				
110	6				
70	4				
105	5				
70	4				
60	5				
55	4				
55	3				
50	2				
		55	3		
		40	3		
		35	3		
		25	2		
		25	2		
				100	6
				90	6
				80	5
				80	5
				80	5
				80	5
				120	7
				100	6
		90	6		
		40	3		
		35	2		
				200	7
				180	7
				150	7
				120	7
				180	7
				70	6
				180	7
				120	6
				70	6
				50	6
				45	6
				35	5

## HT 800 WP Application Recommendations

All data are approximate values. The actually achievable cutting speeds and feed rates depend on the respective machining conditions. We recommend suitable drilling trials.

For selecting the optimal tool and the recommended cutting parameters for your application there is also an electronic version of GühringNavigator available at [www.guehring.de](http://www.guehring.de)

- for through holes supporting lands must remain in permanent contact.
- don't apply drilling tool without trial for interrupted cutting (grooves, transverse holes). For interrupted cutting (max. 0.2xD) it is recommended to reduce the feed rate whenever possible.
- in contrast to conventional indexable inserts, HT 800 tools are also suitable for the drilling of stacked sheets.
- on a lathe (stationary tool) it must be ensured that the tool is accurately centred.
- pre-condition for optimal machining results is a sufficient cooling lubricant supply with soluble or neat oil.
- the tool is only of limited suitability for dry machining or MQL. For MQL application we recommend the use of the conical MQL shank end as well as Gühring MQL components. Please contact our Sales Management.

Drill-Ø mm	Feed column no.								
	1	2	3	4	5	6	7	8	9
	f (mm/rev.)								
<b>0.50</b>	0.004	0.006	0.007	0.008	0.010	0.012	0.014	0.016	0.019
<b>1.00</b>	0.006	0.008	0.012	0.014	0.016	0.018	0.020	0.023	0.025
<b>2.00</b>	0.020	0.025	0.032	0.040	0.050	0.063	0.080	0.100	0.125
<b>2.50</b>	0.025	0.032	0.040	0.050	0.063	0.080	0.100	0.125	0.160
<b>3.15</b>	0.032	0.040	0.050	0.063	0.080	0.100	0.125	0.160	0.200
<b>4.00</b>	0.040	0.050	0.063	0.080	0.100	0.125	0.160	0.200	0.250
<b>5.00</b>	0.040	0.050	0.063	0.080	0.100	0.125	0.160	0.200	0.250
<b>6.30</b>	0.050	0.063	0.080	0.100	0.125	0.160	0.200	0.250	0.315
<b>8.00</b>	0.063	0.080	0.100	0.125	0.160	0.200	0.250	0.315	0.400
<b>10.00</b>	0.080	0.100	0.125	0.160	0.200	0.250	0.315	0.400	0.500
<b>12.50</b>	0.080	0.100	0.125	0.160	0.200	0.250	0.315	0.400	0.500
<b>16.00</b>	0.100	0.125	0.160	0.200	0.250	0.315	0.400	0.500	0.630
<b>20.00</b>	0.125	0.160	0.200	0.250	0.315	0.400	0.500	0.630	0.800
<b>25.00</b>	0.160	0.200	0.250	0.315	0.400	0.500	0.630	0.800	1.000
<b>31.50</b>	0.160	0.200	0.250	0.315	0.400	0.500	0.630	0.800	1.000
<b>40.00</b>	0.200	0.250	0.315	0.400	0.500	0.630	0.800	1.000	1.250



Coolant:

- air
- neat oil
- soluble oil

Material group	Material examples, <b>new description</b> (old description in brackets) Figures in bold = material no. to DIN EN	Tensile strength MPa (N/mm <sup>2</sup> )	Hard- ness	Cool- ant
Common structural steels	<b>1.0035</b> S185(St33), <b>1.0486</b> P275N(StE285), <b>1.0345</b> P235GH(H1), <b>1.0425</b> P265GH(H2) <b>1.0050</b> E295 (St50-2), <b>1.0070</b> E360 (St70-2), <b>1.8937</b> P500NH (WStE500)	≤500 >500-850		○ ●
Free-cutting steels	<b>1.0718</b> 11SMnPb30 (9SMnPb28), <b>1.0736</b> 11SMn37 (9SMn36) <b>1.0727</b> 46S20 (45S20), <b>1.0728</b> (60S20), <b>1.0757</b> 46SPb20 (45SPb20)	≤850 850-1000		○ ●
Unalloyed heat-treatable steels	<b>1.0402</b> C22, <b>1.1178</b> C30E (Ck30) <b>1.0503</b> C45, <b>1.1191</b> C45E (Ck45) <b>1.0601</b> C60, <b>1.1221</b> C60E (Ck60)	≤ 700 700-850 850-1000		○ ● ●
Alloyed heat-treatable steels	<b>1.5131</b> 50MnSi4, <b>1.7003</b> 38Cr2, <b>1.7030</b> 28Cr4 <b>1.5710</b> 36NiCr6, <b>1.7035</b> 41Cr4, <b>1.7225</b> 42CrMo4	850-≤1000 1000-1200		○ ●
Unalloyed case hardened steels	<b>1.0301</b> (C10), <b>1.1121</b> C10E (Ck10)	≤750		○
Alloyed case hardened steels	<b>1.7043</b> 38Cr4 <b>1.5752</b> 15NiCr13 (15NiCr13), <b>1.7131</b> 16MnCr5, <b>1.7264</b> 20CrMo5	850-≤1000 1000-1200		○ ●
Nitriding steels	<b>1.8504</b> 34CrAl6 <b>1.8519</b> 31CrMoV9, <b>1.8550</b> 34CrAlNi7	≥850-≤1000 >1000-1200		○ ●
Tool steels	<b>1.1750</b> C75W, <b>1.2067</b> 102Cr6, <b>1.2307</b> 29CrMoV9 <b>1.2080</b> X210Cr12, <b>1.2083</b> X42Cr13, <b>1.2419</b> 105WCr6, <b>1.2767</b> X45NiCrMo4	≤850 >850-1000		○ ●
High speed steels	<b>1.3243</b> S 6-5-2-5, <b>1.3343</b> S 6-5-2, <b>1.3344</b> S 6-5-3	≥650-1000		○
Spring steels	<b>1.5026</b> 55Si7, <b>1.7176</b> 55Cr3, <b>1.8159</b> 51CrV4 (51CrV4)		≤330 HB	○
Stainless steels, sulphured austenitic martensitic	<b>1.4005</b> X12CrS13, <b>1.4104</b> X14CrMoS17, <b>1.4105</b> X6CrMoS17, <b>1.4305</b> X8CrNiS18-9 <b>1.4301</b> X5CrNi18-10 (V2A), <b>1.4541</b> X6CrNiTi18-10, <b>1.4571</b> X6CrNiMoTi 17-12-2 (V4A) <b>1.4057</b> X20CrNi 172 (X17CrNi16-2), <b>1.4122</b> X39CrMo17-1, <b>1.4521</b> X2CrMoTi18-2	≤850 ≤850 ≤850		○ ● ●
Hardened steels	-		≤40-48 HRC >48-60 HRC	○ ●
Special alloys	Nimonic, Inconel, Monel, Hastelloy	≤1200		○
Cast iron	<b>0.6010</b> EN-GJL-100(GG10), <b>0.6020</b> EN-GJL-200(GG20) <b>0.6025</b> EN-GJL-250(GG25), <b>0.6035</b> EN-GJL-350(GG35)		≤240 HB <300 HB	○ ○
New cast materials CGI	<b>EN-GJV250</b> (GGV25), <b>EN-GJV350</b> (GGV35) <b>EN-GJV400</b> (GGV40), <b>EN-GJV500</b> (GGV50), SiMo 6		≤220 HB <300 HB	○ ○
New cast materials ADI	<b>EN-GJS-800-8</b> (ADI800), <b>EN-GJS-1000-5</b> (ADI1000) <b>EN-GJS-1200-2</b> (ADI1200), <b>EN-GJS-1400-1</b> (ADI1400)	800-1000 1200-1400		○ ○
Spheroidal graphite iron and malleable cast iron	<b>0.7050</b> EN-GJS-500-7(GGG50), <b>0.8035</b> EN-GJMW-350-4(GTW35) <b>0.7070</b> EN-GJS-700-2(GGG70), <b>0.8170</b> EN-GJMB-700-2(GTS70)		≤240 HB <300 HB	○ ○
Chilled cast iron	-		≤350 HB	○
Ti and Ti-alloys	<b>3.7024</b> Ti99,5, <b>3.7114</b> TiAl5Sn2,5, <b>3.7124</b> TiCu2 <b>3.7154</b> TiAl6Zr5, <b>3.7165</b> TiAl6V4, <b>3.7184</b> TiAl4Mo4Sn2,5, -TiAl8Mo1V1	≤850 >850-1200		○ ●
Aluminium and Al-alloys	<b>3.0255</b> Al99,5, <b>3.2315</b> AlMgSi1, <b>3.3515</b> AlMg1	≤400		○
Al wrought alloys	<b>3.0615</b> AlMgSiPb, <b>3.1325</b> AlCuMg1, <b>3.3245</b> AlMg3Si, <b>3.4365</b> AlZnMgCu1,5	≤450		○
Al cast alloys ≤ 10 % Si > 10 % Si	<b>3.2131</b> G-AlSi5Cu1, <b>3.2153</b> G-AlSi7Cu3, <b>3.2573</b> G-AlSi9 <b>3.2581</b> G-AlSi12, <b>3.2583</b> G-AlSi12Cu, - G-AlSi12CuNiMg	≤600 ≤600		○ ○
Magnesium alloys	<b>3.5200</b> MgMn2, <b>3.5812.05</b> G-MgAl8Zn1, <b>3.5612.05</b> G-MgAl6Zn1	≤450		○
Copper, low-alloyed	<b>2.0070</b> SE-Cu, <b>2.1020</b> CuSn6, <b>2.1096</b> G-CuSn5ZnPb	≤400		○
Brass, short-chipping long-chipping	<b>2.0380</b> CuZn39Pb2, <b>2.0401</b> CuZn39Pb3, <b>2.0410</b> CuZn43Pb2 <b>2.0250</b> CuZn20, <b>2.0280</b> CuZn33, <b>2.0332</b> CuZn37Pb0,5	≤600 ≤600		○ ○
Bronze, short-chipping	<b>2.1090</b> CuSn7ZnPb, <b>2.1170</b> CuPb5Sn5, <b>2.1176</b> CuPb10Sn <b>2.0790</b> CuNi18Zn19Pb	≤600 >600-850		○ ●
Bronze, long-chipping	<b>2.0916</b> CuAl5, <b>2.0960</b> CuAl9Mn, <b>2.1050</b> CuSn10 <b>2.0980</b> CuAl11Ni, <b>2.1247</b> CuBe2	≤850 >850-1000		○ ●

## Tool holders $\leq 3 \times D$ , Guhring no. 4107



Guhring no.	4112	4115	4113	4114	
	Tool material	Solid carbide	Solid carbide	Solid carbide	
Carbide grade	K/P	K/P	K/P	K	
Surface finish	nanoFIRE	nanoA	FIRE	bright	
Application	steel	stainless steel	cast iron	Al and Al-alloys	
					
$V_c$ m/min	Feed column no.	$V_c$ m/min	Feed column no.	$V_c$ m/min	Feed column no.
130	6				
110	5				
130	7				
110	6				
130	6				
125	6				
110	5				
110	6				
90	5				
130	7				
110	6				
70	4				
105	5				
70	4				
60	5				
55	4				
55	3				
50	2				
		55	3		
		40	3		
		35	3		
		25	2		
		25	2		
				100	6
				90	6
				80	5
				80	5
				80	5
				80	5
				120	7
				100	6
		90	6		
		40	3		
		35	2		
				200	7
				180	7
				150	7
				120	7
				180	7
				70	6
				180	7
				120	6
				70	6
				50	6
				45	6
				35	5

# HT 800 WP Application Recommendations

All data are approximate values. The actually achievable cutting speeds and feed rates depend on the respective machining conditions. We recommend suitable drilling trials.

For selecting the optimal tool and the recommended cutting parameters for your application there is also an electronic version of GühringNavigator available at [www.guehring.de](http://www.guehring.de)

- for through holes supporting lands must remain in permanent contact. In addition, we recommend reducing the feed rate prior to exiting.
- for drilling depths from 5xD we generally recommend centring or pilot drilling with holder, Guhring no. 4105, and pilot insert, Guhring no. 4111. Alternatively – depending on the material to be machined – Ratio drills type RT 100 U or RT 100VA can be applied.
- for drilling without centring we recommend reducing the feed rate at the start of the hole.
- don't apply drilling tool without trial for interrupted cutting (grooves, transverse holes). For interrupted cutting (max. 0.2xD) it is recommended to reduce the feed rate whenever possible.
- in contrast to conventional indexable inserts, HT 800 tools are also suitable for the drilling of stacked sheets.
- on a lathe (stationary tool) it must be ensured that the tool is accurately centred.
- pre-condition for optimal machining results is a sufficient cooling lubricant supply with soluble or neat oil.
- the tool is only of limited suitability for dry machining or MQL. For MQL application we recommend the use of the conical MQL shank end as well as Guhring MQL components. Please contact our Sales Management.

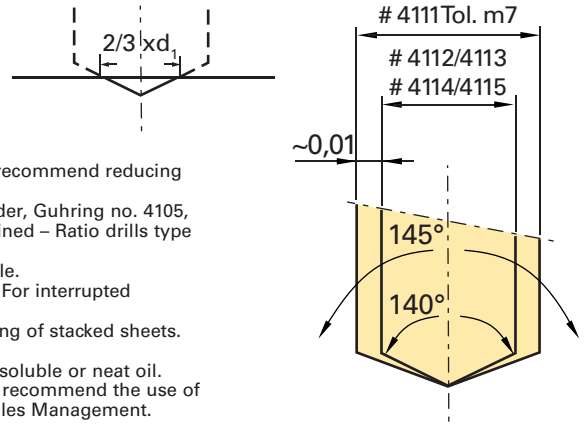

Drill-Ø mm	Feed column no.								
	1	2	3	4	5	6	7	8	9
	f (mm/rev.)								
0.50	0.004	0.006	0.007	0.008	0.010	0.012	0.014	0.016	0.019
1.00	0.006	0.008	0.012	0.014	0.016	0.018	0.020	0.023	0.025
2.00	0.020	0.025	0.032	0.040	0.050	0.063	0.080	0.100	0.125
2.50	0.025	0.032	0.040	0.050	0.063	0.080	0.100	0.125	0.160
3.15	0.032	0.040	0.050	0.063	0.080	0.100	0.125	0.160	0.160
4.00	0.040	0.050	0.063	0.080	0.100	0.125	0.160	0.200	0.200
5.00	0.040	0.050	0.063	0.080	0.100	0.125	0.160	0.200	0.250
6.30	0.050	0.063	0.080	0.100	0.125	0.160	0.200	0.250	0.315
8.00	0.063	0.080	0.100	0.125	0.160	0.200	0.250	0.315	0.315
10.00	0.080	0.100	0.125	0.160	0.200	0.250	0.315	0.400	0.400
12.50	0.080	0.100	0.125	0.160	0.200	0.250	0.315	0.400	0.500
16.00	0.100	0.125	0.160	0.200	0.250	0.315	0.400	0.500	0.630
20.00	0.125	0.160	0.200	0.250	0.315	0.400	0.500	0.630	0.630
25.00	0.160	0.200	0.250	0.315	0.400	0.500	0.630	0.800	0.800
31.50	0.160	0.200	0.250	0.315	0.400	0.500	0.630	0.800	1.000
40.00	0.200	0.250	0.315	0.400	0.500	0.630	0.800	1.000	1.250

Coolant:  
 ○ air  
 ● neat oil  
 ● soluble oil

Material group	Material examples, <b>new description</b> (old description in brackets) Figures in bold = material no. to DIN EN	Tensile strength MPa (N/mm <sup>2</sup> )	Hard- ness	Cool- ant
Common structural steels	<b>1.0035</b> S185(St33), <b>1.0486</b> P275N(StE285), <b>1.0345</b> P235GH(H1), <b>1.0425</b> P265GH(H2) <b>1.0050</b> E295 (St50-2), <b>1.0070</b> E360 (St70-2), <b>1.8937</b> P500NH (WStE500)	≤500 >500-850		●
Free-cutting steels	<b>1.0718</b> 11SMnPb30 (9SMnPb28), <b>1.0736</b> 11SMn37 (9SMn36) <b>1.0727</b> 46S20 (45S20), <b>1.0728</b> (60S20), <b>1.0757</b> 46SPb20 (45SPb20)	≤850 850-1000		●
Unalloyed heat-treatable steels	<b>1.0402</b> C22, <b>1.1178</b> C30E (Ck30) <b>1.0503</b> C45, <b>1.1191</b> C45E (Ck45) <b>1.0601</b> C60, <b>1.1221</b> C60E (Ck60)	≤ 700 700-850 850-1000		●
Alloyed heat-treatable steels	<b>1.5131</b> 50MnSi4, <b>1.7003</b> 38Cr2, <b>1.7030</b> 28Cr4 <b>1.5710</b> 36NiCr6, <b>1.7035</b> 41Cr4, <b>1.7225</b> 42CrMo4	850-≤1000 1000-1200		●
Unalloyed case hardened steels	<b>1.0301</b> (C10), <b>1.1121</b> C10E (Ck10)	≤750		●
Alloyed case hardened steels	<b>1.7043</b> 38Cr4 <b>1.5752</b> 15NiCr13 (15NiCr13), <b>1.7131</b> 16MnCr5, <b>1.7264</b> 20CrMo5	850-≤1000 1000-1200		●
Nitriding steels	<b>1.8504</b> 34CrAl6 <b>1.8519</b> 31CrMoV9, <b>1.8550</b> 34CrAlNi7	≥850-≤1000 >1000-1200		●
Tool steels	<b>1.1750</b> C75W, <b>1.2067</b> 102Cr6, <b>1.2307</b> 29CrMoV9 <b>1.2080</b> X210Cr12, <b>1.2083</b> X42Cr13, <b>1.2419</b> 105WCr6, <b>1.2767</b> X45NiCrMo4	≤850 >850-1000		●
High speed steels	<b>1.3243</b> S 6-5-2-5, <b>1.3343</b> S 6-5-2, <b>1.3344</b> S 6-5-3	≥650-1000		●
Spring steels	<b>1.5026</b> 55Si7, <b>1.7176</b> 55Cr3, <b>1.8159</b> 51CrV4 (51CrV4)		≤330 HB	●
Stainless steels, sulphured austenitic martensitic	<b>1.4005</b> X12CrS13, <b>1.4104</b> X14CrMoS17, <b>1.4105</b> X6CrMoS17, <b>1.4305</b> X8CrNiS18-9 <b>1.4301</b> X5CrNi18-10 (V2A), <b>1.4541</b> X6CrNiTi18-10, <b>1.4571</b> X6CrNiMoTi 17-12-2 (V4A) <b>1.4057</b> X20CrNi 17 2 (X17CrNi16-2), <b>1.4122</b> X39CrMo17-1, <b>1.4521</b> X2CrMoTi18-2	≤850 ≤850 ≤850		●
Hardened steels	-		≤40-48 HRC >48-60 HRC	●
Special alloys	Nimonic, Inconel, Monel, Hastelloy	≤1200		●
Cast iron	<b>0.6010</b> EN-GJL-100(GG10), <b>0.6020</b> EN-GJL-200(GG20) <b>0.6025</b> EN-GJL-250(GG25), <b>0.6035</b> EN-GJL-350(GG35)		≤240 HB <300 HB	●
New cast materials CGI	<b>EN-GJV250</b> (GGV25), <b>EN-GJV350</b> (GGV35) <b>EN-GJV400</b> (GGV40), <b>EN-GJV500</b> (GGV50), SiMo 6		≤220 HB <300 HB	●
New cast materials ADI	<b>EN-GJS-800-8</b> (ADI800), <b>EN-GJS-1000-5</b> (ADI1000) <b>EN-GJS-1200-2</b> (ADI1200), <b>EN-GJS-1400-1</b> (ADI1400)	800-1000 1200-1400		●
Spheroidal graphite iron and malleable cast iron	<b>0.7050</b> EN-GJS-500-7(GGG50), <b>0.8035</b> EN-GJMW-350-4(GTW35) <b>0.7070</b> EN-GJS-700-2(GGG70), <b>0.8170</b> EN-GJMB-700-2(GTS70)		≤240 HB <300 HB	●
Chilled cast iron	-		≤350 HB	●
Ti and Ti-alloys	<b>3.7024</b> Ti99,5, <b>3.7114</b> TiAl5Sn2,5, <b>3.7124</b> TiCu2 <b>3.7154</b> TiAl6Zr5, <b>3.7165</b> TiAl6V4, <b>3.7184</b> TiAl4Mo4Sn2,5, -TiAl8Mo1V1	≤850 >850-1200		●
Aluminium and Al-alloys	<b>3.0255</b> Al99,5, <b>3.2315</b> AlMgSi1, <b>3.3515</b> AlMg1	≤400		●
Al wrought alloys	<b>3.0615</b> AlMgSiPb, <b>3.1325</b> AlCuMg1, <b>3.3245</b> AlMg3Si, <b>3.4365</b> AlZnMgCu1,5	≤450		●
Al cast alloys ≤ 10 % Si > 10 % Si	<b>3.2131</b> G-AlSi5Cu1, <b>3.2153</b> G-AlSi7Cu3, <b>3.2573</b> G-AlSi9 <b>3.2581</b> G-AlSi12, <b>3.2583</b> G-AlSi12Cu, - G-AlSi12CuNiMg	≤600 ≤600		●
Magnesium alloys	<b>3.5200</b> MgMn2, <b>3.5812.05</b> G-MgAl8Zn1, <b>3.5612.05</b> G-MgAl6Zn1	≤450		○
Copper, low-alloyed	<b>2.0070</b> SE-Cu, <b>2.1020</b> CuSn6, <b>2.1096</b> G-CuSn5ZnPb	≤400		●
Brass, short-chipping long-chipping	<b>2.0380</b> CuZn39Pb2, <b>2.0401</b> CuZn39Pb3, <b>2.0410</b> CuZn43Pb2 <b>2.0250</b> CuZn20, <b>2.0280</b> CuZn33, <b>2.0332</b> CuZn37Pb0,5	≤600 ≤600		●
Bronze, short-chipping	<b>2.1090</b> CuSn7ZnPb, <b>2.1170</b> CuPb5Sn5, <b>2.1176</b> CuPb10Sn <b>2.0790</b> CuNi18Zn19Pb	≤600 >600-850		●
Bronze, long-chipping	<b>2.0916</b> CuAl5, <b>2.0960</b> CuAl9Mn, <b>2.1050</b> CuSn10 <b>2.0980</b> CuAl11Ni, <b>2.1247</b> CuBe2	≤850 >850-1000		●

## Tool holders $\leq 5 \times D$ , Guhring no. 4108



Guhring no.	4112	4115	4113	4114	
	Tool material Carbide grade Surface finish Application	<b>Solid carbide</b> K/P nanoFIRE steel	<b>Solid carbide</b> K/P nanoA stainless steel	<b>Solid carbide</b> K/P FIRE cast iron	<b>Solid carbide</b> K bright Al and Al-alloys
$V_c$ m/min	Feed column no.	$V_c$ m/min	Feed column no.	$V_c$ m/min	Feed column no.
125	6				
105	5				
125	7				
105	6				
125	6				
120	6				
105	5				
105	6				
85	5				
125	7				
105	6				
70	4				
105	5				
70	4				
55	5				
50	4				
55	3				
50	2				
		55	3		
		40	3		
		35	3		
		25	2		
		25	2		
				100	6
				90	6
				80	5
				80	5
				80	5
				80	5
				120	7
				100	6
		90	6		
		40	3		
		35	2		
				180	7
				180	7
				140	7
				110	7
				180	7
				70	6
				180	7
				120	6
				70	6
				50	6
				45	6
				35	5

# HT 800 WP Application Recommendations

All data are approximate values. The actually achievable cutting speeds and feed rates depend on the respective machining conditions. We recommend suitable drilling trials.

For selecting the optimal tool and the recommended cutting parameters for your application there is also an electronic version of GühringNavigator available at [www.guehring.de](http://www.guehring.de)

- for through holes supporting lands must remain in permanent contact. In addition, we recommend reducing the feed rate prior to exiting.
- for drilling depths from 5xD we generally recommend centring or pilot drilling with holder, Gühring no. 4105, and pilot insert, Gühring no. 4111. Alternatively – depending on the material to be machined – Ratio drills type RT 100 U or RT 100VA can be applied.
- for drilling without centring we recommend reducing the feed rate at the start of the hole.
- don't apply drilling tool without trial for interrupted cutting (grooves, transverse holes). For interrupted cutting (max. 0.2xD) it is recommended to reduce the feed rate whenever possible.
- in contrast to conventional indexable inserts, HT 800 tools are also suitable for the drilling of stacked sheets.
- on a lathe (stationary tool) it must be ensured that the tool is accurately centred.
- pre-condition for optimal machining results is a sufficient cooling lubricant supply with soluble or neat oil.
- the tool is only of limited suitability for dry machining or MQL. For MQL application we recommend the use of the conical MQL shank end as well as Gühring MQL components. Please contact our Sales Management.

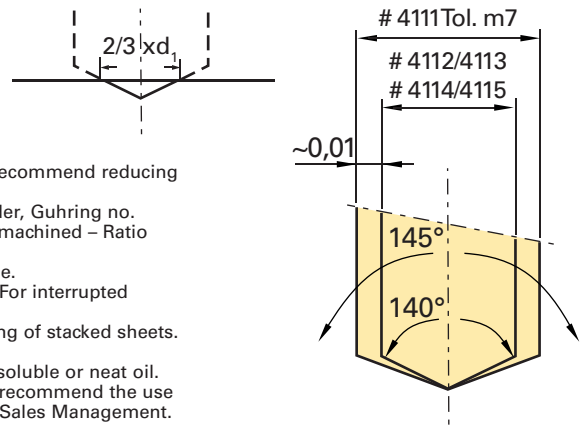

Drill-Ø mm	Feed column no.								
	1	2	3	4	5	6	7	8	9
	f (mm/rev.)								
0.50	0.004	0.006	0.007	0.008	0.010	0.012	0.014	0.016	0.019
1.00	0.006	0.008	0.012	0.014	0.016	0.018	0.020	0.023	0.025
2.00	0.020	0.025	0.032	0.040	0.050	0.063	0.080	0.100	0.125
2.50	0.025	0.032	0.040	0.050	0.063	0.080	0.100	0.125	0.160
3.15	0.032	0.040	0.050	0.063	0.080	0.100	0.125	0.160	0.160
4.00	0.040	0.050	0.063	0.080	0.100	0.125	0.160	0.200	0.200
5.00	0.040	0.050	0.063	0.080	0.100	0.125	0.160	0.200	0.250
6.30	0.050	0.063	0.080	0.100	0.125	0.160	0.200	0.250	0.315
8.00	0.063	0.080	0.100	0.125	0.160	0.200	0.250	0.315	0.315
10.00	0.080	0.100	0.125	0.160	0.200	0.250	0.315	0.400	0.400
12.50	0.080	0.100	0.125	0.160	0.200	0.250	0.315	0.400	0.500
16.00	0.100	0.125	0.160	0.200	0.250	0.315	0.400	0.500	0.630
20.00	0.125	0.160	0.200	0.250	0.315	0.400	0.500	0.630	0.630
25.00	0.160	0.200	0.250	0.315	0.400	0.500	0.630	0.800	0.800
31.50	0.160	0.200	0.250	0.315	0.400	0.500	0.630	0.800	1.000
40.00	0.200	0.250	0.315	0.400	0.500	0.630	0.800	1.000	1.250





- Coolant:
- air
  - neat oil
  - soluble oil

Material group	Material examples, <b>new description</b> (old description in brackets) Figures in bold = material no. to DIN EN	Tensile strength MPa (N/mm <sup>2</sup> )	Hard- ness	Cool- ant
Common structural steels	<b>1.0035</b> S185(St33), <b>1.0486</b> P275N(StE285), <b>1.0345</b> P235GH(H1), <b>1.0425</b> P265GH(H2) <b>1.0050</b> E295 (St50-2), <b>1.0070</b> E360 (St70-2), <b>1.8937</b> P500NH (WStE500)	≤500 >500-850		●
Free-cutting steels	<b>1.0718</b> 11SMnPb30 (9SMnPb28), <b>1.0736</b> 11SMn37 (9SMn36) <b>1.0727</b> 46S20 (45S20), <b>1.0728</b> (60S20), <b>1.0757</b> 46SPb20 (45SPb20)	≤850 850-1000		●
Unalloyed heat-treatable steels	<b>1.0402</b> C22, <b>1.1178</b> C30E (Ck30) <b>1.0503</b> C45, <b>1.1191</b> C45E (Ck45) <b>1.0601</b> C60, <b>1.1221</b> C60E (Ck60)	≤ 700 700-850 850-1000		●
Alloyed heat-treatable steels	<b>1.5131</b> 50MnSi4, <b>1.7003</b> 38Cr2, <b>1.7030</b> 28Cr4 <b>1.5710</b> 36NiCr6, <b>1.7035</b> 41Cr4, <b>1.7225</b> 42CrMo4	850-≤1000 1000-1200		●
Unalloyed case hardened steels	<b>1.0301</b> (C10), <b>1.1121</b> C10E (Ck10)	≤750		●
Alloyed case hardened steels	<b>1.7043</b> 38Cr4 <b>1.5752</b> 15NiCr13 (15NiCr13), <b>1.7131</b> 16MnCr5, <b>1.7264</b> 20CrMo5	850-≤1000 1000-1200		●
Nitriding steels	<b>1.8504</b> 34CrAl6 <b>1.8519</b> 31CrMoV9, <b>1.8550</b> 34CrAlNi7	≥850-≤1000 >1000-1200		●
Tool steels	<b>1.1750</b> C75W, <b>1.2067</b> 102Cr6, <b>1.2307</b> 29CrMoV9 <b>1.2080</b> X210Cr12, <b>1.2083</b> X42Cr13, <b>1.2419</b> 105WCr6, <b>1.2767</b> X45NiCrMo4	≤850 >850-1000		●
High speed steels	<b>1.3243</b> S 6-5-2-5, <b>1.3343</b> S 6-5-2, <b>1.3344</b> S 6-5-3	≥650-1000		●
Spring steels	<b>1.5026</b> 55Si7, <b>1.7176</b> 55Cr3, <b>1.8159</b> 51CrV4 (51CrV4)		≤330 HB	●
Stainless steels, sulphured austenitic martensitic	<b>1.4005</b> X12CrS13, <b>1.4104</b> X14CrMoS17, <b>1.4105</b> X6CrMoS17, <b>1.4305</b> X8CrNiS18-9 <b>1.4301</b> X5CrNi18-10 (V2A), <b>1.4541</b> X6CrNiTi18-10, <b>1.4571</b> X6CrNiMoTi 17-12-2 (V4A) <b>1.4057</b> X20CrNi 17 2 (X17CrNi16-2), <b>1.4122</b> X39CrMo17-1, <b>1.4521</b> X2CrMoTi18-2	≤850 ≤850 ≤850		●
Hardened steels	-		≤40-48 HRC >48-60 HRC	●
Special alloys	Nimonic, Inconel, Monel, Hastelloy	≤1200		●
Cast iron	<b>0.6010</b> EN-GJL-100(GG10), <b>0.6020</b> EN-GJL-200(GG20) <b>0.6025</b> EN-GJL-250(GG25), <b>0.6035</b> EN-GJL-350(GG35)		≤240 HB <300 HB	●
New cast materials CGI	<b>EN-GJV250</b> (GGV25), <b>EN-GJV350</b> (GGV35) <b>EN-GJV400</b> (GGV40), <b>EN-GJV500</b> (GGV50), SiMo 6		≤220 HB <300 HB	●
New cast materials ADI	<b>EN-GJS-800-8</b> (ADI800), <b>EN-GJS-1000-5</b> (ADI1000) <b>EN-GJS-1200-2</b> (ADI1200), <b>EN-GJS-1400-1</b> (ADI1400)	800-1000 1200-1400		●
Spheroidal graphite iron and malleable cast iron	<b>0.7050</b> EN-GJS-500-7(GGG50), <b>0.8035</b> EN-GJMW-350-4(GTW35) <b>0.7070</b> EN-GJS-700-2(GGG70), <b>0.8170</b> EN-GJMB-700-2(GTS70)		≤240 HB <300 HB	●
Chilled cast iron	-		≤350 HB	●
Ti and Ti-alloys	<b>3.7024</b> Ti99,5, <b>3.7114</b> TiAl5Sn2,5, <b>3.7124</b> TiCu2 <b>3.7154</b> TiAl6Zr5, <b>3.7165</b> TiAl6V4, <b>3.7184</b> TiAl4Mo4Sn2,5, -TiAl8Mo1V1	≤850 >850-1200		●
Aluminium and Al-alloys	<b>3.0255</b> Al99,5, <b>3.2315</b> AlMgSi1, <b>3.3515</b> AlMg1	≤400		●
Al wrought alloys	<b>3.0615</b> AlMgSiPb, <b>3.1325</b> AlCuMg1, <b>3.3245</b> AlMg3Si, <b>3.4365</b> AlZnMgCu1,5	≤450		●
Al cast alloys ≤ 10 % Si > 10 % Si	<b>3.2131</b> G-AlSi5Cu1, <b>3.2153</b> G-AlSi7Cu3, <b>3.2573</b> G-AlSi9 <b>3.2581</b> G-AlSi12, <b>3.2583</b> G-AlSi12Cu, - G-AlSi12CuNiMg	≤600 ≤600		●
Magnesium alloys	<b>3.5200</b> MgMn2, <b>3.5812.05</b> G-MgAl8Zn1, <b>3.5612.05</b> G-MgAl6Zn1	≤450		○
Copper, low-alloyed	<b>2.0070</b> SE-Cu, <b>2.1020</b> CuSn6, <b>2.1096</b> G-CuSn5ZnPb	≤400		●
Brass, short-chipping long-chipping	<b>2.0380</b> CuZn39Pb2, <b>2.0401</b> CuZn39Pb3, <b>2.0410</b> CuZn43Pb2 <b>2.0250</b> CuZn20, <b>2.0280</b> CuZn33, <b>2.0332</b> CuZn37Pb0,5	≤600 ≤600		●
Bronze, short-chipping	<b>2.1090</b> CuSn7ZnPb, <b>2.1170</b> CuPb5Sn5, <b>2.1176</b> CuPb10Sn <b>2.0790</b> CuNi18Zn19Pb	≤600 >600-850		●
Bronze, long-chipping	<b>2.0916</b> CuAl5, <b>2.0960</b> CuAl9Mn, <b>2.1050</b> CuSn10 <b>2.0980</b> CuAl11Ni, <b>2.1247</b> CuBe2	≤850 >850-1000		●



## Tool holders $\leq 7 \times D$ , Guhring no. 4109



Guhring no.	4112	4115	4113	4114	
	Tool material Carbide grade Surface finish Application	Solid carbide K/P nanoFIRE steel	Solid carbide K/P nanoA stainless steel	Solid carbide K/P FIRE cast iron	Solid carbide K bright Al and Al-alloys
					
$V_c$ m/min	Feed column no.	$V_c$ m/min	Feed column no.	$V_c$ m/min	Feed column no.
120	5				
105	4				
120	6				
105	5				
120	5				
110	5				
100	4				
100	5				
85	4				
120	6				
100	5				
70	4				
105	4				
70	3				
55	4				
50	3				
55	2				
50	2				
		55	2		
		40	2		
		35	2		
		25	1		
		25	1		
				80	6
				70	6
				60	5
				60	5
				60	5
				60	5
				100	7
				80	6
		70	6		
		40	2		
		35	1		
				180	6
				180	6
				140	6
				110	6
				180	6
				70	5
				180	6
				120	5
				70	5
				50	5
				45	5
				35	4

# HT 800 WP Application Recommendations

All data are approximate values. The actually achievable cutting speeds and feed rates depend on the respective machining conditions. We recommend suitable drilling trials.

For selecting the optimal tool and the recommended cutting parameters for your application there is also an electronic version of GühringNavigator available at [www.guehring.de](http://www.guehring.de)

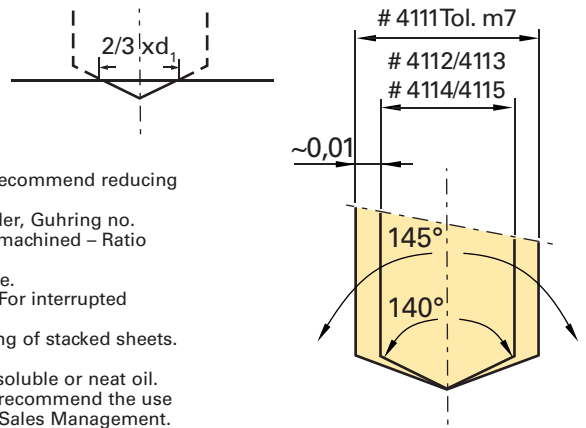

- for through holes supporting lands must remain in permanent contact. In addition, we recommend reducing the feed rate prior to exiting.
- for drilling depths from 5xD we generally recommend centring or pilot drilling with holder, Gühring no. 4105, and pilot insert, Gühring no. 4111. Alternatively – depending on the material to be machined – Ratio drills type RT 100 U or RT 100VA can be applied.
- for drilling without centring we recommend reducing the feed rate at the start of the hole.
- don't apply drilling tool without trial for interrupted cutting (grooves, transverse holes). For interrupted cutting (max. 0.2xD) it is recommended to reduce the feed rate whenever possible.
- in contrast to conventional indexable inserts, HT 800 tools are also suitable for the drilling of stacked sheets.
- on a lathe (stationary tool) it must be ensured that the tool is accurately centred.
- pre-condition for optimal machining results is a sufficient cooling lubricant supply with soluble or neat oil.
- the tool is only of limited suitability for dry machining or MQL. For MQL application we recommend the use of the conical MQL shank end as well as Gühring MQL components. Please contact our Sales Management.





Drill-Ø mm	Feed column no.								
	1	2	3	4	5	6	7	8	9
	f (mm/rev.)								
0.50	0.004	0.006	0.007	0.008	0.010	0.012	0.014	0.016	0.019
1.00	0.006	0.008	0.012	0.014	0.016	0.018	0.020	0.023	0.025
2.00	0.020	0.025	0.032	0.040	0.050	0.063	0.080	0.100	0.125
2.50	0.025	0.032	0.040	0.050	0.063	0.080	0.100	0.125	0.160
3.15	0.032	0.040	0.050	0.063	0.080	0.100	0.125	0.160	0.200
4.00	0.040	0.050	0.063	0.080	0.100	0.125	0.160	0.200	0.250
5.00	0.040	0.050	0.063	0.080	0.100	0.125	0.160	0.200	0.250
6.30	0.050	0.063	0.080	0.100	0.125	0.160	0.200	0.250	0.315
8.00	0.063	0.080	0.100	0.125	0.160	0.200	0.250	0.315	0.400
10.00	0.080	0.100	0.125	0.160	0.200	0.250	0.315	0.400	0.500
12.50	0.080	0.100	0.125	0.160	0.200	0.250	0.315	0.400	0.500
16.00	0.100	0.125	0.160	0.200	0.250	0.315	0.400	0.500	0.630
20.00	0.125	0.160	0.200	0.250	0.315	0.400	0.500	0.630	0.800
25.00	0.160	0.200	0.250	0.315	0.400	0.500	0.630	0.800	1.000
31.50	0.160	0.200	0.250	0.315	0.400	0.500	0.630	0.800	1.000
40.00	0.200	0.250	0.315	0.400	0.500	0.630	0.800	1.000	1.250

- Coolant:
- air
  - neat oil
  - soluble oil





Material group	Material examples, <b>new description</b> (old description in brackets) Figures in bold = material no. to DIN EN	Tensile strength MPa (N/mm <sup>2</sup> )	Hard- ness	Cool- ant
Common structural steels	<b>1.0035</b> S185(St33), <b>1.0486</b> P275N(StE285), <b>1.0345</b> P235GH(H1), <b>1.0425</b> P265GH(H2) <b>1.0050</b> E295 (St50-2), <b>1.0070</b> E360 (St70-2), <b>1.8937</b> P500NH (WStE500)	≤500 >500-850		●
Free-cutting steels	<b>1.0718</b> 11SMnPb30 (9SMnPb28), <b>1.0736</b> 11SMn37 (9SMn36) <b>1.0727</b> 46S20 (45S20), <b>1.0728</b> (60S20), <b>1.0757</b> 46SPb20 (45SPb20)	≤850 850-1000		●
Unalloyed heat-treatable steels	<b>1.0402</b> C22, <b>1.1178</b> C30E (Ck30) <b>1.0503</b> C45, <b>1.1191</b> C45E (Ck45) <b>1.0601</b> C60, <b>1.1221</b> C60E (Ck60)	≤ 700 700-850 850-1000		●
Alloyed heat-treatable steels	<b>1.5131</b> 50MnSi4, <b>1.7003</b> 38Cr2, <b>1.7030</b> 28Cr4 <b>1.5710</b> 36NiCr6, <b>1.7035</b> 41Cr4, <b>1.7225</b> 42CrMo4	850-≤1000 1000-1200		●
Unalloyed case hardened steels	<b>1.0301</b> (C10), <b>1.1121</b> C10E (Ck10)	≤750		●
Alloyed case hardened steels	<b>1.7043</b> 38Cr4 <b>1.5752</b> 15NiCr13 (15NiCr13), <b>1.7131</b> 16MnCr5, <b>1.7264</b> 20CrMo5	850-≤1000 1000-1200		●
Nitriding steels	<b>1.8504</b> 34CrAl6 <b>1.8519</b> 31CrMoV9, <b>1.8550</b> 34CrAlNi7	≥850-≤1000 >1000-1200		●
Tool steels	<b>1.1750</b> C75W, <b>1.2067</b> 102Cr6, <b>1.2307</b> 29CrMoV9 <b>1.2080</b> X210Cr12, <b>1.2083</b> X42Cr13, <b>1.2419</b> 105WCr6, <b>1.2767</b> X45NiCrMo4	≤850 >850-1000		●
High speed steels	<b>1.3243</b> S 6-5-2-5, <b>1.3343</b> S 6-5-2, <b>1.3344</b> S 6-5-3	≥650-1000		●
Spring steels	<b>1.5026</b> 55Si7, <b>1.7176</b> 55Cr3, <b>1.8159</b> 51CrV4 (51CrV4)		≤330 HB	●
Stainless steels, sulphured austenitic martensitic	<b>1.4005</b> X12CrS13, <b>1.4104</b> X14CrMoS17, <b>1.4105</b> X6CrMoS17, <b>1.4305</b> X8CrNiS18-9 <b>1.4301</b> X5CrNi18-10 (V2A), <b>1.4541</b> X6CrNiTi18-10, <b>1.4571</b> X6CrNiMoTi 17-12-2 (V4A) <b>1.4057</b> X20CrNi 17 2 (X17CrNi16-2), <b>1.4122</b> X39CrMo17-1, <b>1.4521</b> X2CrMoTi18-2	≤850 ≤850 ≤850		●
Hardened steels	-		≤40-48 HRC >48-60 HRC	●
Special alloys	Nimonic, Inconel, Monel, Hastelloy	≤1200		●
Cast iron	<b>0.6010</b> EN-GJL-100(GG10), <b>0.6020</b> EN-GJL-200(GG20) <b>0.6025</b> EN-GJL-250(GG25), <b>0.6035</b> EN-GJL-350(GG35)		≤240 HB <300 HB	●
New cast materials CGI	<b>EN-GJV250</b> (GGV25), <b>EN-GJV350</b> (GGV35) <b>EN-GJV400</b> (GGV40), <b>EN-GJV500</b> (GGV50), SiMo 6		≤220 HB <300 HB	●
New cast materials ADI	<b>EN-GJS-800-8</b> (ADI800), <b>EN-GJS-1000-5</b> (ADI1000) <b>EN-GJS-1200-2</b> (ADI1200), <b>EN-GJS-1400-1</b> (ADI1400)	800-1000 1200-1400		●
Spheroidal graphite iron and malleable cast iron	<b>0.7050</b> EN-GJS-500-7(GGG50), <b>0.8035</b> EN-GJMW-350-4(GTW35) <b>0.7070</b> EN-GJS-700-2(GGG70), <b>0.8170</b> EN-GJMB-700-2(GTS70)		≤240 HB <300 HB	●
Chilled cast iron	-		≤350 HB	●
Ti and Ti-alloys	<b>3.7024</b> Ti99,5, <b>3.7114</b> TiAl5Sn2,5, <b>3.7124</b> TiCu2 <b>3.7154</b> TiAl6Zr5, <b>3.7165</b> TiAl6V4, <b>3.7184</b> TiAl4Mo4Sn2,5, -TiAl8Mo1V1	≤850 >850-1200		●
Aluminum and Al-alloys	<b>3.0255</b> Al99,5, <b>3.2315</b> AlMgSi1, <b>3.3515</b> AlMg1	≤400		●
Al wrought alloys	<b>3.0615</b> AlMgSiPb, <b>3.1325</b> AlCuMg1, <b>3.3245</b> AlMg3Si, <b>3.4365</b> AlZnMgCu1,5	≤450		●
Al cast alloys ≤ 10 % Si > 10 % Si	<b>3.2131</b> G-AlSi5Cu1, <b>3.2153</b> G-AlSi7Cu3, <b>3.2573</b> G-AlSi9 <b>3.2581</b> G-AlSi12, <b>3.2583</b> G-AlSi12Cu, - G-AlSi12CuNiMg	≤600 ≤600		●
Magnesium alloys	<b>3.5200</b> MgMn2, <b>3.5812.05</b> G-MgAl8Zn1, <b>3.5612.05</b> G-MgAl6Zn1	≤450		○
Copper, low-alloyed	<b>2.0070</b> SE-Cu, <b>2.1020</b> CuSn6, <b>2.1096</b> G-CuSn5ZnPb	≤400		●
Brass, short-chipping long-chipping	<b>2.0380</b> CuZn39Pb2, <b>2.0401</b> CuZn39Pb3, <b>2.0410</b> CuZn43Pb2 <b>2.0250</b> CuZn20, <b>2.0280</b> CuZn33, <b>2.0332</b> CuZn37Pb0,5	≤600 ≤600		●
Bronze, short-chipping	<b>2.1090</b> CuSn7ZnPb, <b>2.1170</b> CuPb5Sn5, <b>2.1176</b> CuPb10Sn <b>2.0790</b> CuNi18Zn19Pb	≤600 >600-850		●
Bronze, long-chipping	<b>2.0916</b> CuAl5, <b>2.0960</b> CuAl9Mn, <b>2.1050</b> CuSn10 <b>2.0980</b> CuAl11Ni, <b>2.1247</b> CuBe2	≤850 >850-1000		●

## Tool holders $\leq 10 \times D$ , Guhring no. 4110



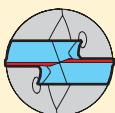
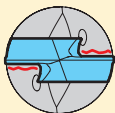
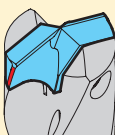

Guhring no.	4112	4115	4113	4114	
	Tool material Carbide grade Surface finish Application	<b>Solid carbide</b> K/P nanoFIRE steel	<b>Solid carbide</b> K/P nanoA stainless steel	<b>Solid carbide</b> K/P FIRE cast iron	<b>Solid carbide</b> K bright Al and Al-alloys
					
$V_c$ m/min	Feed column no.	$V_c$ m/min	Feed column no.	$V_c$ m/min	Feed column no.
100	5				
95	4				
100	6				
95	5				
100	5				
95	5				
90	4				
90	5				
85	4				
100	6				
90	5				
70	4				
95	4				
70	3				
55	4				
50	3				
55	2				
50	2				
		55	2		
		40	2		
		35	2		
		25	1		
		25	1		
				80	6
				70	6
				60	5
				60	5
				60	5
				60	5
				100	7
				80	6
		70	6		
		40	2		
		35	1		
				150	6
				150	6
				130	6
				105	6
				150	6
				70	5
				150	6
				110	5
				70	5
				50	5
				45	5
				35	4

# 12 tips to help diagnose problems

Problem	Cause	Remedy
<b>1 Cutting edge build up</b> 	<ul style="list-style-type: none"> <li>■ low cutting speed</li> <li>■ excessive honing of cutting lip</li> <li>■ bright finish cutting lip</li> </ul>	<ul style="list-style-type: none"> <li>■ increase cutting speed</li> <li>■ reduce cutting lip honing</li> <li>■ have tool coated</li> </ul>
<b>2 Crumbling of outer corners</b> 	<ul style="list-style-type: none"> <li>■ non rigid conditions, insufficient workpiece clamping</li> <li>■ deviation from concentricity too large</li> <li>■ interrupted cut</li> </ul>	<ul style="list-style-type: none"> <li>■ rigid clamping of workpiece</li> <li>■ check and correct concentricity if possible</li> <li>■ reduce feed</li> </ul>
<b>3 Heavy wear at flank</b> 	<ul style="list-style-type: none"> <li>■ cutting speed too high</li> <li>■ feed too low</li> <li>■ clearance angle too small</li> </ul>	<ul style="list-style-type: none"> <li>■ reduce cutting speed</li> <li>■ increase feed</li> <li>■ increase clearance angle</li> </ul>
<b>4 Crumbling on cutting lips</b> 	<ul style="list-style-type: none"> <li>■ non rigid conditions, insufficient workpiece clamping</li> <li>■ interrupted cut</li> <li>■ max. wear values exceeded</li> <li>■ incorrect tool type</li> </ul>	<ul style="list-style-type: none"> <li>■ rigid clamping of workpiece</li> <li>■ reduce feed</li> <li>■ reduce tool change intervals</li> <li>■ apply suitable tool</li> </ul>
<b>5 Land wear</b> 	<ul style="list-style-type: none"> <li>■ non rigid conditions, insufficient workpiece clamping</li> <li>■ deviation from concentricity too large</li> <li>■ back taper too small</li> <li>■ incorrect coolant (oil), coolant too weak</li> </ul>	<ul style="list-style-type: none"> <li>■ rigid clamping of workpiece</li> <li>■ check and correct concentricity if possible</li> <li>■ increase back taper</li> <li>■ increase strength of coolant or use neat oil</li> </ul>
<b>6 Scoring on tool body</b> 	<ul style="list-style-type: none"> <li>■ non rigid conditions, insufficient workpiece clamping</li> <li>■ deviation from concentricity too large</li> <li>■ interrupted cut</li> <li>■ abrasive workpiece material</li> </ul>	<ul style="list-style-type: none"> <li>■ rigid clamping of workpiece</li> <li>■ check and correct concentricity if possible</li> <li>■ reduce feed</li> <li>■ increase strength of coolant or use neat oil</li> </ul>

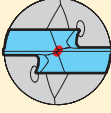
# 12 tips to help diagnose problems

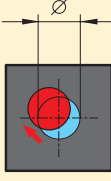
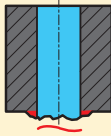
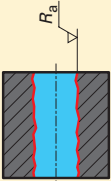
Problem	Cause	Remedy
<b>7 Heavy chisel edge wear</b> 	<ul style="list-style-type: none"> <li>■ cutting speed too low</li> <li>■ feed too high</li> <li>■ excessive honing of cutting lip</li> </ul>	<ul style="list-style-type: none"> <li>■ increase cutting speed</li> <li>■ reduce feed</li> <li>■ reduce cutting lip honing</li> </ul>
<b>8 Crumbling at intersection, web thinning and cutting lip</b> 	<ul style="list-style-type: none"> <li>■ clearance angle too small</li> <li>■ excessive honing of cutting lip</li> <li>■ incorrect tool type</li> </ul>	<ul style="list-style-type: none"> <li>■ increase clearance angle</li> <li>■ reduce cutting lip honing</li> <li>■ apply suitable tool</li> </ul>
<b>9 Plastic deformation of outer corner</b> 	<ul style="list-style-type: none"> <li>■ cutting speed too high</li> <li>■ insufficient coolant volume</li> <li>■ incorrect or no honing at corner</li> </ul>	<ul style="list-style-type: none"> <li>■ reduce cutting speed</li> <li>■ increase volume/pressure</li> <li>■ correct honing</li> </ul>
<b>10 Misalignment</b> 	<ul style="list-style-type: none"> <li>■ non rigid conditions, insufficient workpiece clamping</li> <li>■ deviation from concentricity too large</li> <li>■ spotting area transverse</li> <li>■ chisel edge too large</li> </ul>	<ul style="list-style-type: none"> <li>■ rigid clamping of workpiece</li> <li>■ check and correct concentricity if possible</li> <li>■ use milling cutter (2-fluted) for spotting</li> <li>■ reduce chisel edge</li> </ul>
<b>11 Heavy burring on break-through</b> 	<ul style="list-style-type: none"> <li>■ feed too high</li> <li>■ max. wear values exceeded</li> <li>■ excessive honing of cutting lip</li> </ul>	<ul style="list-style-type: none"> <li>■ reduce feed</li> <li>■ reduce tool change intervals</li> <li>■ reduce cutting lip honing</li> </ul>
<b>12 Unsatisfactory surface quality</b> 	<ul style="list-style-type: none"> <li>■ non rigid conditions, insufficient workpiece clamping</li> <li>■ deviation from concentricity too large</li> <li>■ insufficient coolant volume</li> </ul>	<ul style="list-style-type: none"> <li>■ rigid clamping of workpiece</li> <li>■ check and correct concentricity if possible</li> <li>■ increase volume/pressure</li> </ul>

### **FIRE/nanoFIRE**

Coating colour: violet

This TiAlN/TiN multilayer coating is applied to HSS and carbide drills. It offers outstanding wear resistance in drilling operations and high heat resistance. Besides conventional wet applications this coating is suitable for minimum lubrication and dry machining, often combined with MolyGlide to optimise the running-in wear and improved resistance to galling.

### **TiAlN SuperA/nanoA**

Coating colour: grey-violet

The well established A-coating has been developed at Guhring. By optimising the structural, chemical and mechanical properties of the new Super-A coating an extremely high hot hardness, very good oxidation resistance and excellent coating adhesion have been achieved. This coating is used exclusively on carbide cutting tools and is ideally suited for difficult to machine aerospace materials such as titanium alloys, Inconel as well as machining hardened steel materials (>52 HRC) and HSC applications.

### **TiAlN**

Coating colour: violet

The monolayer TiAlN coating is suited for abrasive operations with carbide tools because of its high hardness and chemical resistance, e.g. hard machining and high speed cutting (HSC).

### **TiCN**

Coating colour: grey

End mills and taps exposed to high mechanical load are coated with TiCN. With respect to the high hardness and toughness of TiCN coating the tools offer good machining results operating with interrupted cutting.

### **TiN**

Coating colour: yellow-golden

The monolayer titanium nitride coating is standard for HSS and carbide tools. Used for drilling, tapping and milling operations. Nevertheless, most applications is steel machining.

### **bright**

Due to their basically good properties, high speed steel and carbide tools are supplied without being surface treated, i.e. in a bright finish. Guhring offers bright tools in its standard range only as basic tools for a cost-efficient coating to customer specific requirements.



**Order**       **Enquiry**

Name/customer no. if available New customer

Street/house no.

Telephone

Date

Contact for queries

Order number

Town/post code

Fax

Signature

**Quantity**  holders  inserts

**Material to be machined**

**Machining**

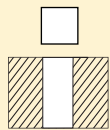
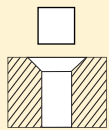
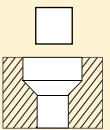
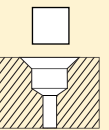
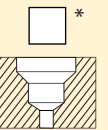
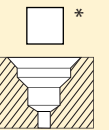

 
 
 
 \* 
 \* 

\*please incl. separate drawing

**Flute**  spiral       partly spiral       straight

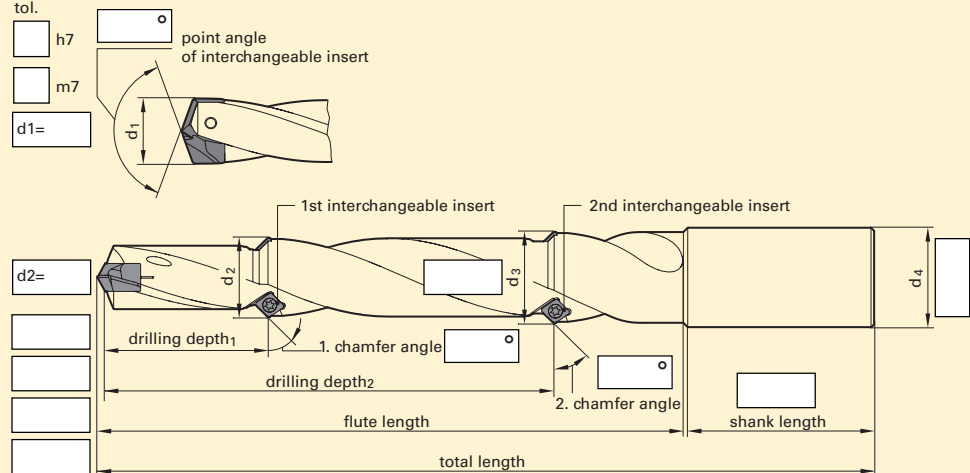

**Dimensions**  
For spiral- & straight-fluted types

tol.  h7       point angle of interchangeable insert  
 m7  
 d1=



d2=   
 drilling depth<sub>1</sub>  
 drilling depth<sub>2</sub>  
 flute length  
 total length  
 shank length

**Shank form**

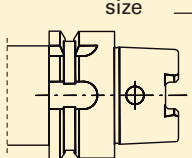
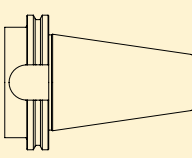
HA 
 HE 
 HSK, form size  
 SK, size  

**Internal cooling**

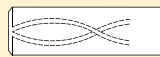
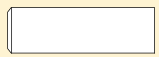
yes 
 no 

**Interchangeable insert coating**

FIRE     TiAlN SuperA     TiAlN     TiCN     TiN     bright

DRILLING

TAPPING/THREAD MILLING/  
FLUTELESS TAPPING

MILLING

REAMING

PCD



SPECIAL TOOLING  
SOLUTIONS

COUNTERSINKING/  
DE-BURRING

MODULAR TOOLING  
SYSTEMS

TOOL RESTORATION SERVICE

# GUHRING

## Gühring oHG

P.O. Box 100247 · D-72423 Albstadt  
Herderstr. 50-54 · D-72458 Albstadt

Telephone: +49 74 31 17-0  
Fax: +49 74 31 17-21 279

[www.guehring.de](http://www.guehring.de)

No liability can be accepted for printing errors or technical changes of any kind.  
Our Conditions of Sale and Terms of Payment apply. Available on request.