

GUHRING

Extremely fast.

Extremely precise.

Extremely small shanks.

NEW

Standard program HSK-A | ISO taper | MAS/BT



HYDRAULIC CHUCK HMC 3000

GUHRING - YOUR WORLD-WIDE PARTNER

With Guhring's new HMC 3000 hydraulic chuck you can for the first time clamp shank diameters smaller than 6 mm directly in the chuck.

Your advantages:

- simple handling
- perfect concentricity $R < 3 \mu\text{m}$ even with extra length chucks
- high clamping force
- quick, simple and accurate length setting
- internal and peripheral cooling
- MQL suitable



|GÜHROJET|

You benefit from:

- > LONGER TOOL LIFE
- > HIGHER PROCESS RELIABILITY
- > IMPROVED MANUFACTURING QUALITY
- > QUICK AND SIMPLE TOOL CHANGE WITH THE SAME HIGH CONCENTRICITY $< 3 \mu\text{m}$

ISO taper hydraulic chucks HMC 3000 for clamping small diameters

Product information

- perfect concentricity: < 3 µm at 10xd1
- balancing quality: G6.3 / 30,000 rev./min
- ISO taper to DIN 69871 form AD/B
- high clamping force
- quick, simple handling and accurate length setting
- IC and GÜHROJET peripheral cooling ensure optimal chip evacuation and tool lubrication

Scope of delivery

- incl. length adjustment screw
- incl. hexagon chuck key Guhring no. 4912
- order pull studs Guhring no. 4925, 4926 separately

GÜHROJET

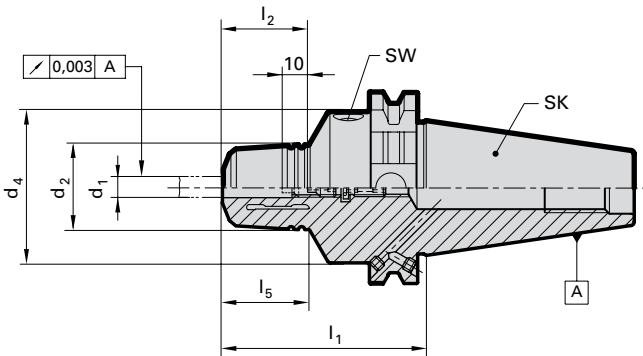

Guhring no.	4619
Discount group	114

ISO taper	for shank Ø d1 h6 mm	d2 mm	d4 mm	l1 mm	l2 mm	l5 mm	SW	Code no.	Availability
40	3	28.0	49.5	84.5	34.0	34.0	5	3,040	●
40	4	28.0	49.5	84.5	34.0	34.0	5	4,040	●
40	5	28.0	49.5	84.5	34.0	34.0	5	5,040	●

MAS/BT hydraulic chucks HMC 3000 for clamping small diameters

Product information

- perfect concentricity: < 3 µm at 10xd1
- balancing quality: G6.3 / 30,000 rev./min
- MAS/BT to JIS B 6339 form AD/B (*: version AD without coolant supply over collar)
- high clamping force
- quick, simple handling and accurate length setting
- IC and GÜHROJET peripheral cooling ensure optimal chip evacuation and tool lubrication

Scope of delivery

- incl. length adjustment screw
- incl. hexagon chuck key Guhring no. 4912
- order pull studs Guhring no. 4927, 4928 separately

GÜHROJET

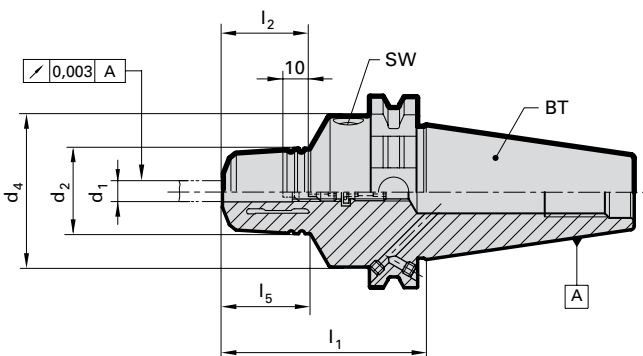

Guhring no.	4620
Discount group	114

BT	for shank Ø d1 h6 mm	d2 mm	d4 mm	l1 mm	l2 mm	l5 mm	SW	Code no.	Availability
30*	3	28.0	-	55.0	34	22.5	4	3,030	●
30*	4	28.0	-	55.0	34	22.5	4	4,030	●
30*	5	28.0	-	55.0	34	22.5	4	5,030	●
40	3	28.0	44.5	94.0	34	48.5	5	3,040	●
40	4	28.0	44.5	94.0	34	48.5	5	4,040	●
40	5	28.0	44.5	94.0	34	48.5	5	5,040	●

Guhring HMC 3000 hydraulic chucks are available for shank diameters from 2 to 5 mm and for all common interfaces such as, for example, HSK 25 to 100, SK 30 to 50 and BT 30 to 50.



GUHRING

GÜHROJET

The compact design of HMC 3000 chucks tailored to the application of very small tools minimises the interference contour of the chuck and offers optimal pre-conditions for high machining speeds.

Thanks to peripheral cooling lubrication the tool's cutting edges are optimally supplied even with external cooling. Of course tools with internal cooling can also be applied in HMC 3000 chucks.

DRILLING

TAPPING/THREAD
MILLING/FLUTELESS
TAPPING

MILLING

REAMING

PCD/PCB



SPECIAL TOOLING
SOLUTIONS

COUNTERSINKING/
DE-BURRING

MODULAR TOOLING SYSTEMS

TOOL RESTORATION SERVICE

GUHRING

Guhring oHG

P.O. Box 100247 • 72423 Albstadt
Herderstraße 50-54 • 72458 Albstadt

Tel. +49 74 31 17-0
Fax +49 74 31 17-21 279
info@guehring.de
www.guehring.de

147 504/1290-VIII-05 • Printed in Germany • 2012

No liability can be accepted for printing errors or technical changes of any kind.
Our Conditions of Sale and Terms of Payment apply. Available on request.
The illustrations show optional equipment.